

INSTALLATION MANUAL

ELECTRONIC MODULAR SWITCHING SYSTEM

KX-T61610

EASA-PHONE

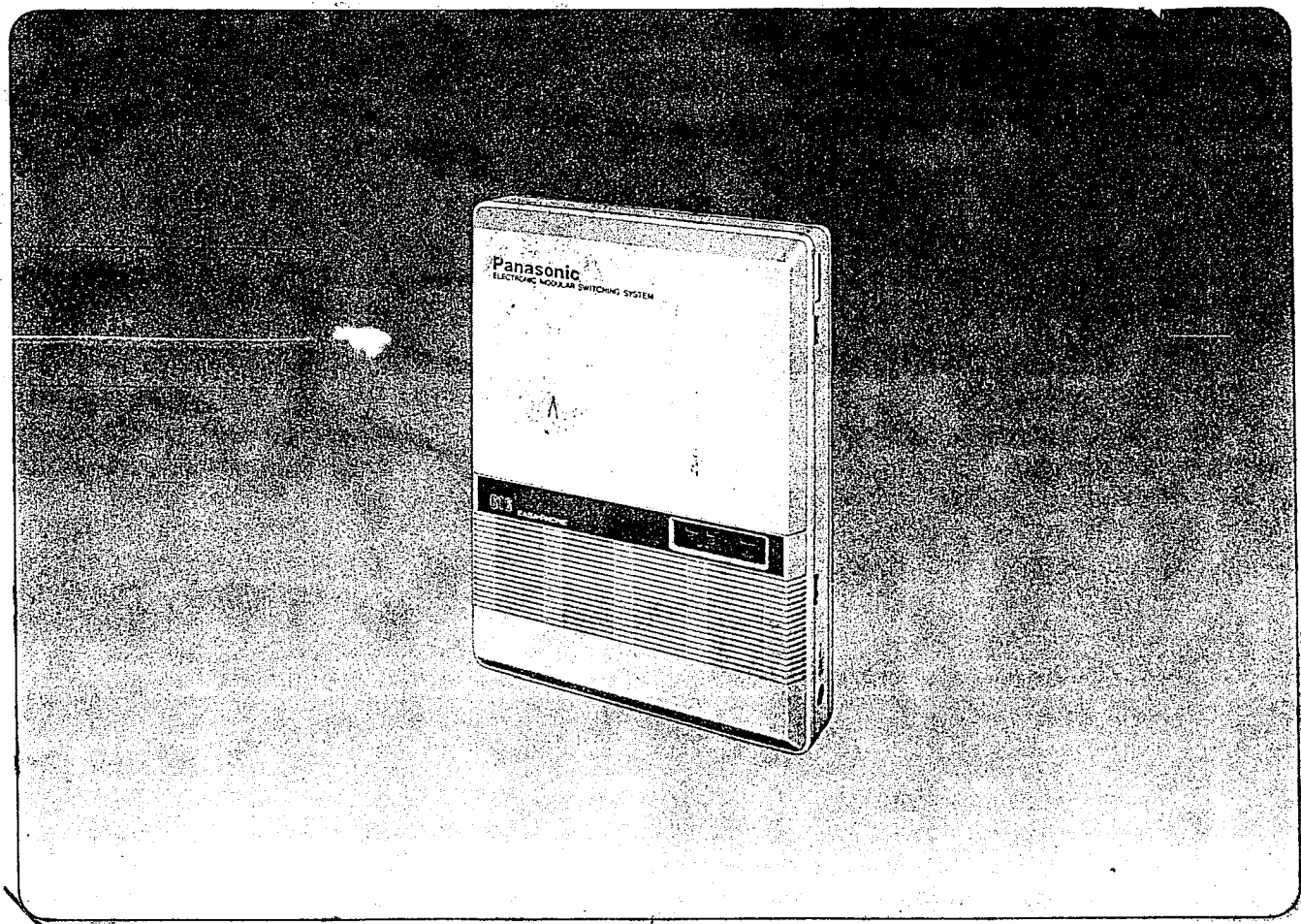

Panasonic

Please read this manual before connecting the KX-T61610.

Quick Reference Card for Standard Telephone can be found on pages 6-22 through 6-29.

*Thank you for purchasing the Panasonic Model KX-T61610,
Electronic Modular Switching System (EMSS).*

System Component

	<i>Model No.</i>	<i>Description</i>
<i>Service unit</i>	<i>KX-T61610</i>	<i>Electronic Modular Switching System</i>
<i>Telephone</i>	<i>KX-T61620 KX-T61630 KX-T61650</i>	<i>EMSS Proprietary Telephone EMSS Proprietary Telephone with LCD EMSS Proprietary Telephone</i>
<i>Optional equipment</i>	<i>KX-T61640 KX-T30860D(only) KX-T30865 KX-T30890 KX-A16</i>	<i>DSS Console Doorphone Adaptor Doorphone Headset System Back-up Unit</i>

NOTIFY THE TELEPHONE COMPANY

Installation must be performed by the telephone company or a qualified professional installer.

Notify the Telephone Company

Before connecting this equipment to any telephone, call the telephone company and inform them of the following:

• Telephone number to which the system will be connected
• Make	Panasonic
• Model	KX-T61610
• FCC Registration No.	found on the bottom of the unit
• Ringer Equivalence	0.4B
• Facility Interface Code	02LS2
• Service Order Code	9.0F
• Required Network Interface Jack	RJ11

- Present FCC Regulations prohibit connecting this unit to a party line, or to a coin operated telephone.

Please read the section on "Telephone Company and FCC Requirements and Responsibilities" on page 6-8.

The serial number of this product may be found on the label affixed to the bottom of the unit. You should note the serial number of this unit in the space provided and retain this book as a permanent record of your purchase to aid in identification in the event of theft.

MODEL NO.: KX-T61610

SERIAL NO.: _____

— For your future reference —

DATE OF PURCHASE _____

NAME OF DEALER _____

DEALER'S ADDRESS _____

TABLE OF CONTENTS

Name and Location		2-1
Installation		2-2
Connection		2-4
Frame Ground Connection		2-5
Rechargeable Battery Installation		2-5
Connection of The Central Office Line		2-6
Connection of the Extension (for Proprietary Telephone KX-T61620/KX-T61630/KX-T61650/KX-T30820/KX-T30830/ KX-T30850)		2-7
Connection of a Standard Telephone to Extensions		2-8
Connection of the DSS Console (KX-T61640) to an Extension		2-9
External Music Source		2-11
Paging Equipment		2-11
Connection of The Optional Doorphone (KX-T30865)		2-12
To Connect a Polarity Sensitive Telephone		2-14
To Connect Optional System Back-up Unit (KX-A16)		2-15
To Connect Printer		2-16
Programming		
Programming Instructions		3-1
Example of Programming		3-3
	Default	
Date and Time Setting	87 JAN. 01 THU 12:00 AM	3-4
System Speed Dialing Entry	has not been stored	3-5
DSS Console Assignment	Console has not been assigned.	3-8
CO Connection Assignment	has been added	3-10
Dial Mode (Tone/Pulse) Selection	TONE	3-11
Switching Mode (Day/Night Service)	manual mode	3-12
Starting Time (Day/Night Service)	day service 9:AM night service 5:PM	3-13
Flexible Day Outward Dialing Assignment	all CO's have been assigned on all extensions	3-15
Flexible Night Outward Dialing Assignment	all CO's have been assigned on all extensions	3-16
Flexible Day Ringing Assignment	all CO's have been assigned on all extensions	3-17
Flexible Night Ringing Assignment	all CO's have been assigned on all extensions	3-18
Toll Restriction—Class Assignment	Class 1	3-19
Toll Restriction—Area Code Selection	has not been stored	3-21

Programmable Toll Prefix	with 1	3-22
Programmable Operator Call	has been added	3-23
Programmable Directory Assistance	no restrict	3-24
Automatic Answering (Automatic/Manual) Selection	Auto Answer	3-25
Host PBX Access Codes Assignment	has not been stored	3-26
Preferred CO Line Assignment	non-assignment	3-27
Programmable Call Waiting	has been removed	3-28
Delayed Ringing Assignment	all CO's have been not delayed on all extensions	3-29
Delayed Ringing Count Selection	After 2 rings	3-30
Intercom Alerting Mode	Tone Call	3-31
Programmable Doorphone	D-Phone 1, 2	3-32
Dial Call Pickup Group Assignment	Pickup-G:1	3-33
Account Code Input Mode	Option	3-34
Duration Time Count Start Mode	5S after dial	3-35
SMDR Communication Parameters	(see pages)	3-36
System Data Dump	System parameters	3-41
SMDR Incoming/Outgoing Selection	Outgoing: ON Incoming: ON	3-44
Hold Time Reminder	3 minutes	3-45
Hold Recall Time Set	30 sec	3-46
Programmable External Paging Access Tone	has been added	3-47
Programmable Secret Speed Dial	No Secret	3-48
Hookswitch Flash Timing	600 msec	3-49
Disconnect Time	1.5 sec	3-50
Calling Party Control (CPC) Signal	has been added	3-51
DSS Button Mode	without transfer	3-52
Transfer Recall Time	30 sec	3-53
M3/FWD Selection (for KX-T30850, KX-T61650)	features	3-54

**Detailed Feature Description and Operation for EMSS
Proprietary Telephone (KX-T61630, KX-T61620, KX-T61650,
KX-T30830, KX-T30820, KX-T30850)**

To Make Calls

Inter Office Calling (Intercom)	4-1
Outward Dialing	4-2
Speed Dialing	4-3
One Touch Dialing	4-4
Calling Doorphone	4-6
Distinctive Dial Tone	4-6

When a Line is Busy

<i>Automatic Call Back Busy—(Camp-on)</i>	4-7
<i>Busy Station Signaling</i>	4-8
<i>Last Number Redial</i>	4-8

To Receive Calls

<i>Answer</i>	4-9
<i>Automatic Answer-Intercom</i>	4-9
<i>Dial Call Pickup</i>	4-10
<i>Directed Call Pickup</i>	4-10
<i>Call Park Retrieve</i>	4-11
<i>Doorphone</i>	4-12
<i>Distinctive Ring Tone</i>	4-12

While Having a Conversation

<i>Call on Hold</i>	4-13
<i>Call on Exclusive Hold</i>	4-14
<i>Conference</i>	4-15
<i>Call Waiting</i>	4-16
<i>Call Transfer</i>	4-17
<i>Call Splitting-Between CO and Intercom</i>	4-18
<i>Call Splitting-Intercom</i>	4-19

Paging

<i>Paging All Extensions</i>	4-19
<i>Paging Group</i>	4-20
<i>Paging—External</i>	4-20
<i>Paging And Transfer</i>	4-21
<i>Paging-Answer</i>	4-21

Use of Other Features

<i>Background Music</i>	4-22
<i>Mute Operation</i>	4-23
<i>One Touch Access for System Features</i>	4-23
<i>External Feature Access</i>	4-24
<i>Account Code</i>	4-25
<i>DSS Console</i>	4-27
<i>Pulse/Tone Conversion</i>	4-29
<i>Time Setting</i>	4-29
<i>Auto CO Hunting</i>	4-30
<i>Flexible CO Button</i>	4-31
<i>Flexible DSS Button</i>	4-31
<i>Intercom Alerting Mode</i>	4-32
<i>Busy Lamp Field</i>	4-32
<i>Power Failure Transfer</i>	4-33
<i>Duration Time of Call Display</i>	4-33
<i>Lockout</i>	4-33
<i>Mixed Station Dialing</i>	4-33

Station Programming

<i>Dial Call Pickup Deny</i>	4-34
<i>Call Forwarding</i>	4-35
<i>Do not Disturb</i>	4-37
<i>Data Line Security</i>	4-38
<i>Saved Number Redial</i>	4-38
<i>Flexible Night Service</i>	4-39
<i>Station Program Clear</i>	4-40

Operation for a Standard Telephone

<i>To Make Calls</i>	5-1
<i>When a Line is Busy</i>	5-2
<i>To Receive Calls</i>	5-3
<i>While Having a Conversation</i>	5-4
<i>Paging</i>	5-5
<i>Use of Other Features</i>	5-7
<i>Station Programming</i>	5-10

Troubleshooting

<i>During Installation</i>	6-1
<i>During Connection</i>	6-2
<i>During Operation</i>	6-3
<i>Reset Button</i>	6-3
<i>DTMF Receiver Check</i>	6-4

<i>Table of System Features</i>	6-5
---------------------------------------	-----

<i>List of Tones</i>	6-6
----------------------------	-----

<i>List of Ring Tones</i>	6-6
---------------------------------	-----

<i>Specification</i>	6-7
----------------------------	-----

Telephone Company and FCC Requirements

<i>and Responsibilities</i>	6-8
-----------------------------------	-----

<i>Others</i>	6-9
---------------------	-----

<i>Warranty</i>	6-10
-----------------------	------

<i>Servicenter List</i>	6-11
-------------------------------	------

<i>Phone Number Directory</i>	6-12
-------------------------------------	------

<i>Programming Table</i>	6-14
--------------------------------	------

<i>Quick Reference Card for Standard Telephone</i>	6-22
--	------

NAME AND LOCATION

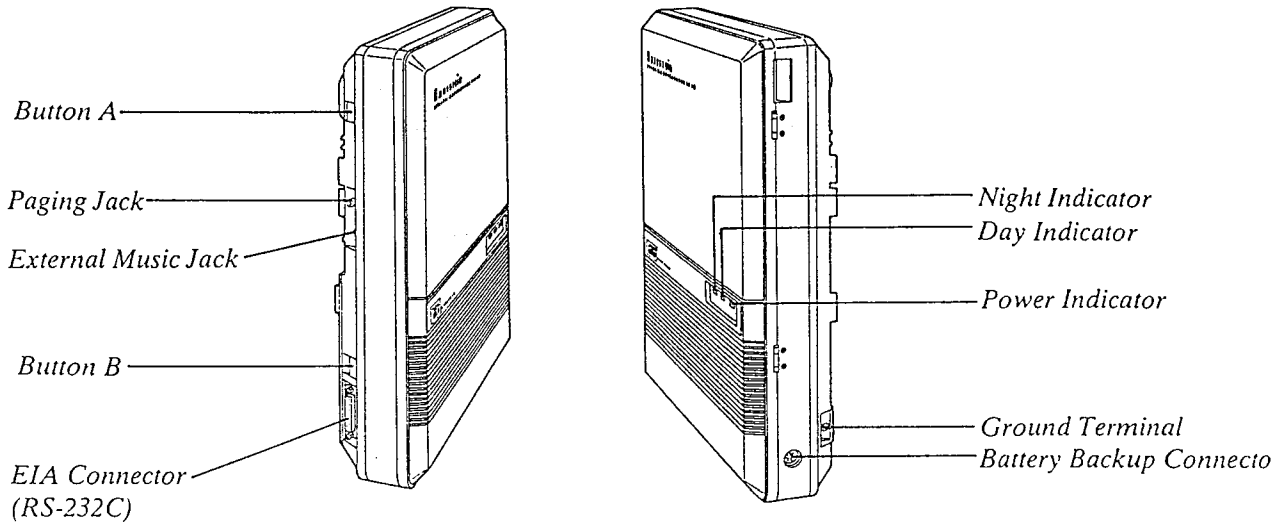

Push Buttons A and B simultaneously to open Front Cover.

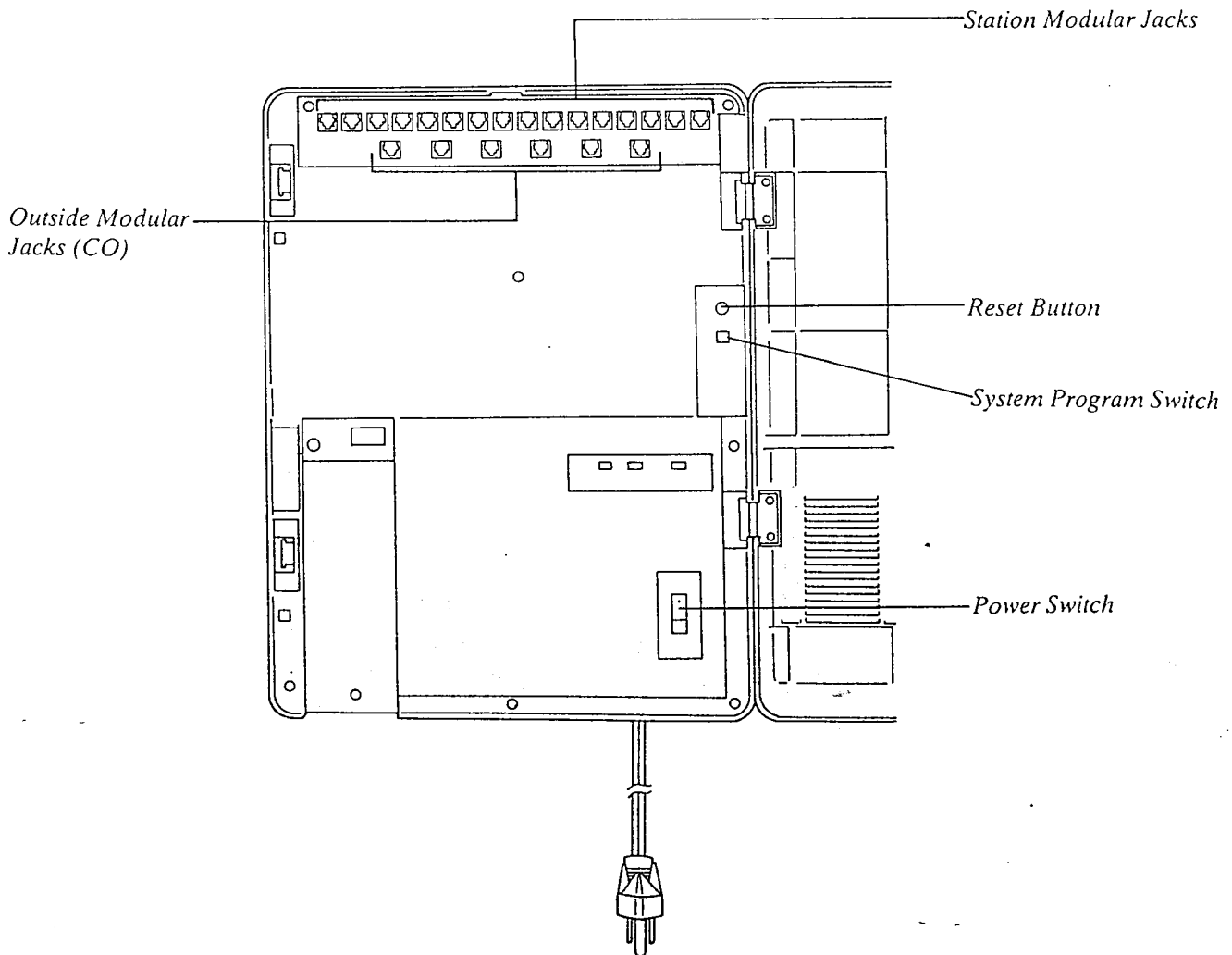

INSTALLATION

Installation

Cautions

• Avoid installing in the following places. (Doing so may result in malfunction, noise, or discoloration.)

1. In direct sunlight and hot, cold, or humid places. (Temperature range: 32°F–104°F)
2. Sulfuric gases produced in areas where there are thermal springs, etc. may damage the equipment or contacts.
3. Places in which shocks or vibrations are frequent or strong.
4. Dusty places, or places where water or oil may come into contact with the unit.
5. Near high-frequency sewing machines or electric welders.
6. On or near computers, telexes, or other office equipment, as well as microwave ovens or air conditioners. (It is preferable not to install in the same room with the above equipment.)
7. Near radio broadcast antennas (including short wave).
8. Install at least 6 feet from radios and televisions. (both the electronic modular switching system and EMSS proprietary telephones)
9. Do not obstruct area around the electronic modular switching system. (for reasons of maintenance and inspection—be especially careful to allow space for cooling above and at the sides of the electronic modular switching system)

Wiring

Cautions

1. Do not wire the telephone cable in parallel with the AC power source, computer, telex etc. If the cables run near those wires, shield the cables with metal tube or use shield cables and ground the shields.
2. When cables run on the floor, use protectors or the like to protect the wires where they may be stepped on. Avoid wiring under carpets.
3. Avoid using the same AC 120 V power supply outlet for computers, telexes, and other office equipment. Otherwise, the KX-T61610's system operation may be interrupted by the induction noise from such equipments.
4. Please use one pair telephone wire for extension connection of (telephone) equipments such as standard telephone, data terminal, answering machine, computer, etc., except proprietary telephone (KX-T61630, KX-T61620, KX-T61650, etc.).

The wall where the KX-T61610 is to be mounted must be able to support a weight of KX-T61610. If screws other than the ones supplied are used, use the same-sized diameter screws as the enclosed ones.

To Wall Mount:

1. Place the templet (included) on the wall to mark the 3 screw positions.

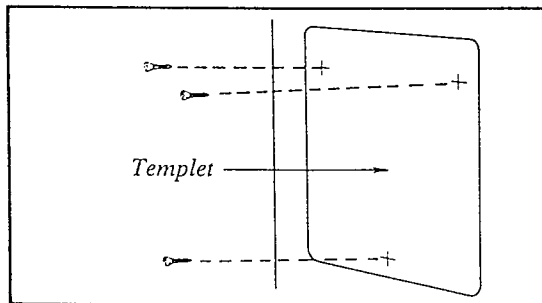

2. Install the 3 screws into the wall.

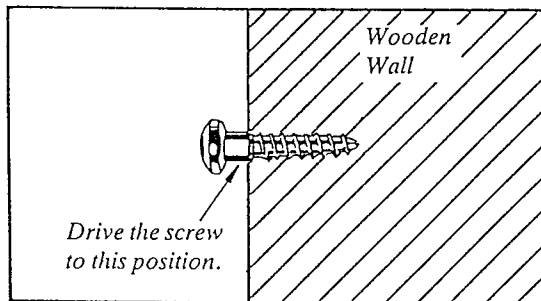

3. Hook the unit on the screw heads.

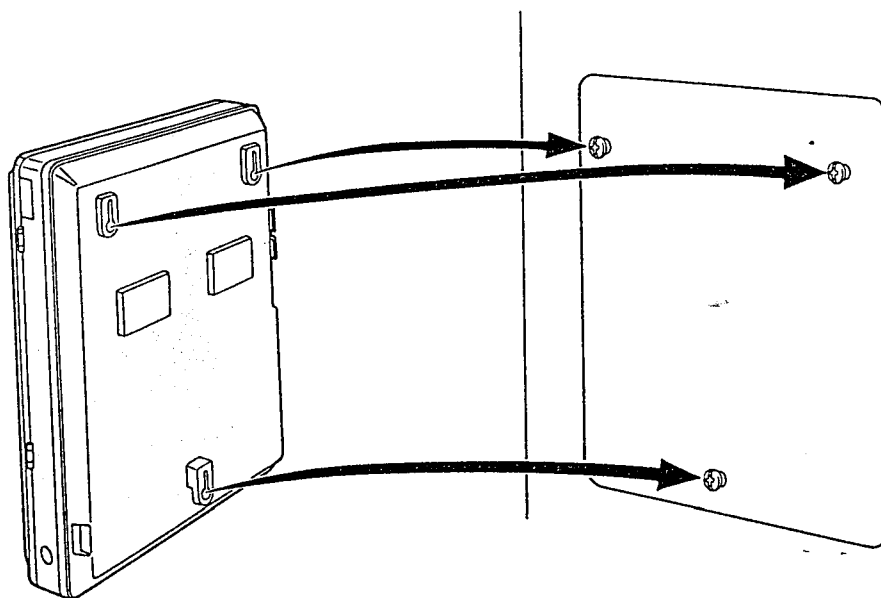

To Mount on Concrete or Mortar Walls:

1. Place the templet (included) to mark 3 screw positions.
2. Drill 3 holes and drive the anchor plugs (included) with a hammer, flush to the wall.

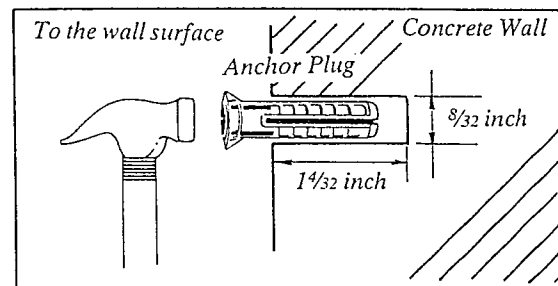

3. Install the 3 screws into the anchor plugs.

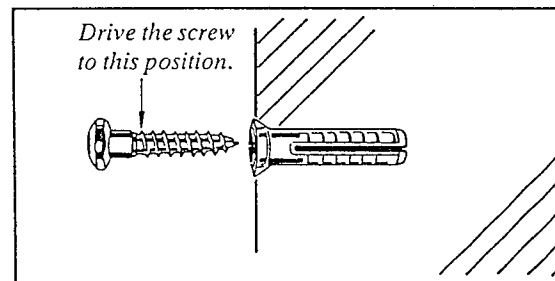

4. Hook the unit on the screw heads.

Frame Ground Connection

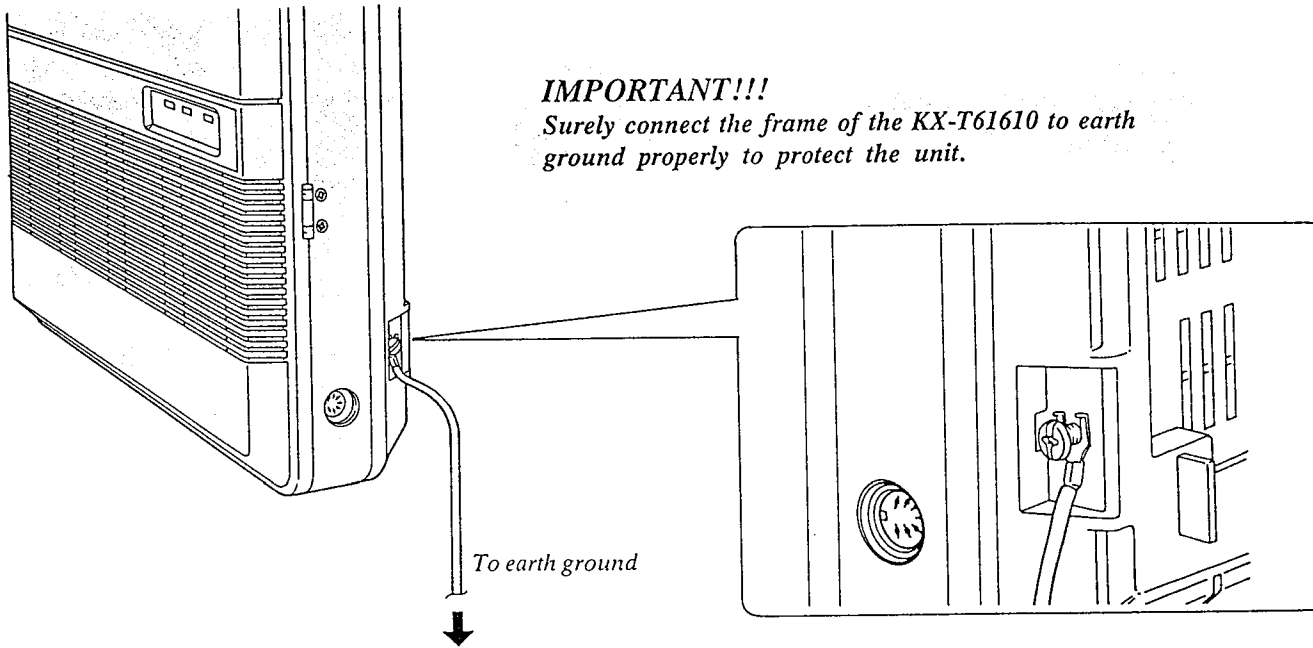

Rechargeable Battery Installation

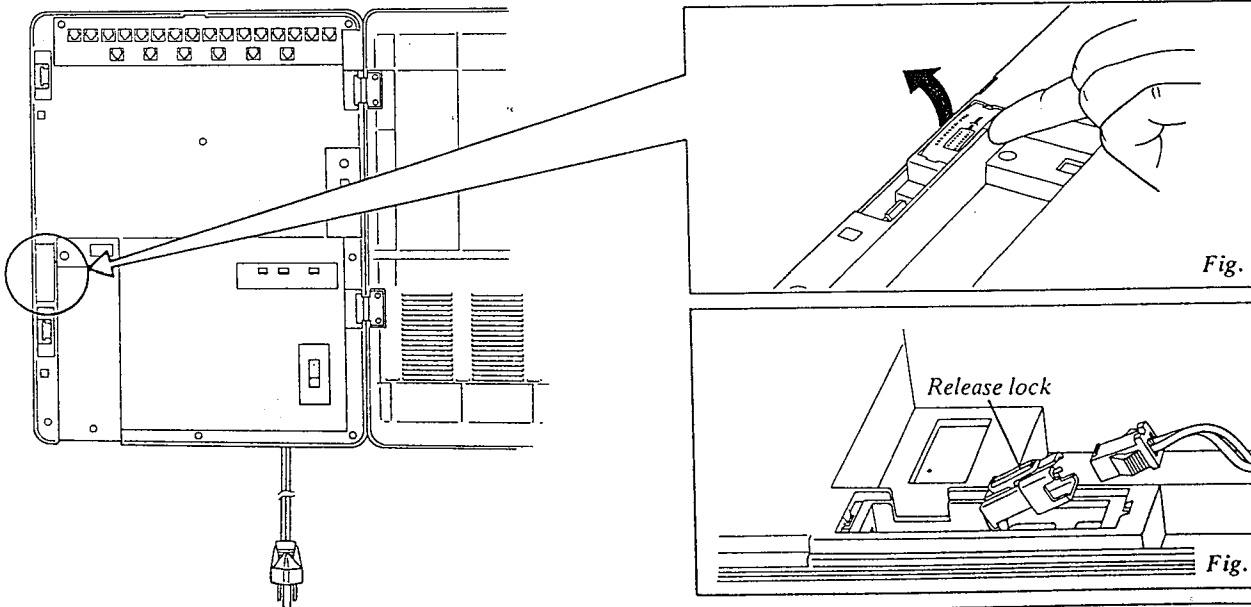

1. Remove the battery cover from the compartment. (Fig. 1)
2. Connect the battery (included). (Fig. 2)
3. Install the battery into the battery compartment. (Fig. 3)

*Replace the battery every 5 years with (P-01H-F2G1). To remove connector, depress to release and slide (pull) apart connector. (Fig. 2)

Connection of The Central Office Line

1. Insert the modular plug of the telephone line cord (2-conductor wiring) into the modular jack (marked CO) on the KX-T61610.
2. Place the six telephone line cords into Holder.

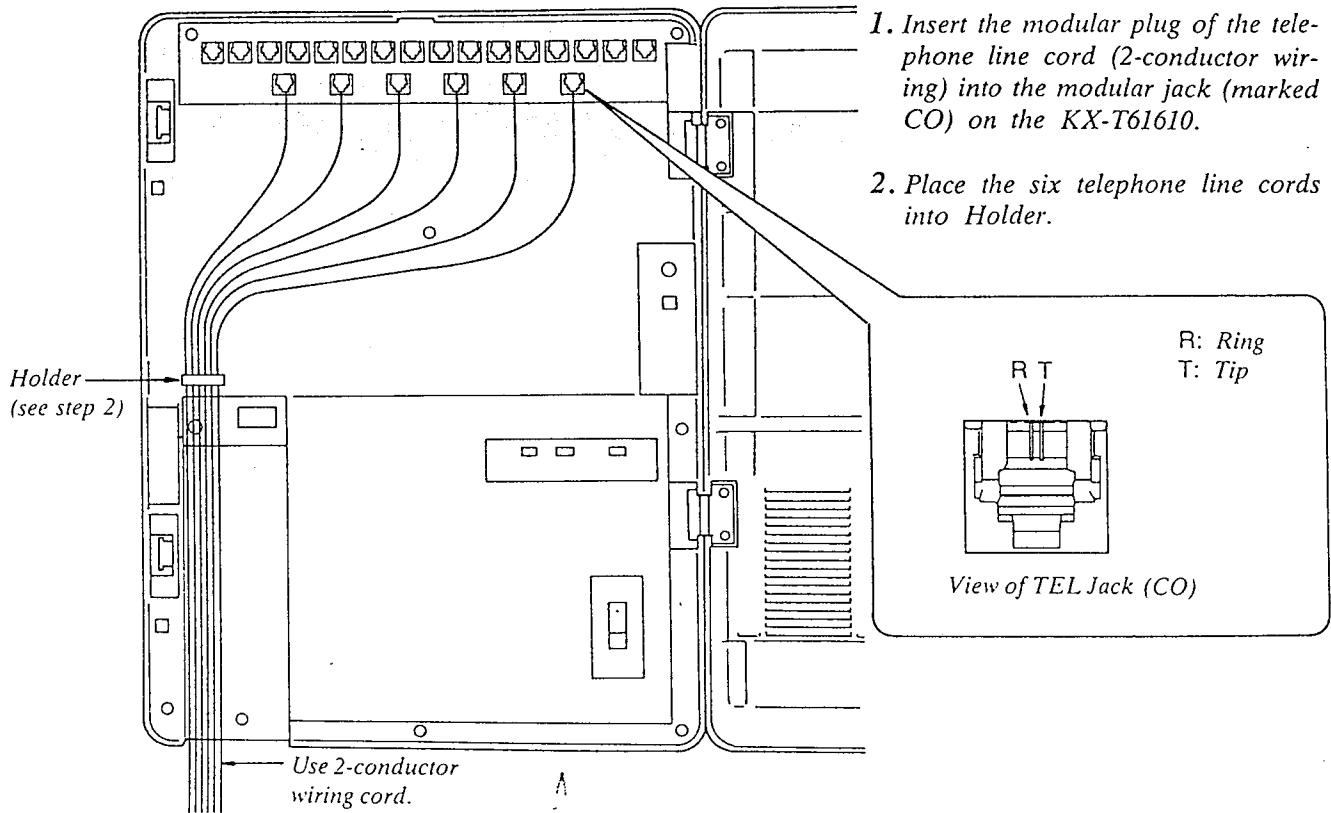

To Terminal Board or Modular Jacks
from the Central Office (CO).

Caution

Mis-connection may cause the KX-T61610 to operate improperly.

See "During Installation" page 6-1 and "During Connection" page 6-2 before connecting.

Connection of The Extension (for Proprietary Telephone KX-T61620/ KX-T61630/KX-T61650/KX-T30820/KX-T30830/KX-T30850)

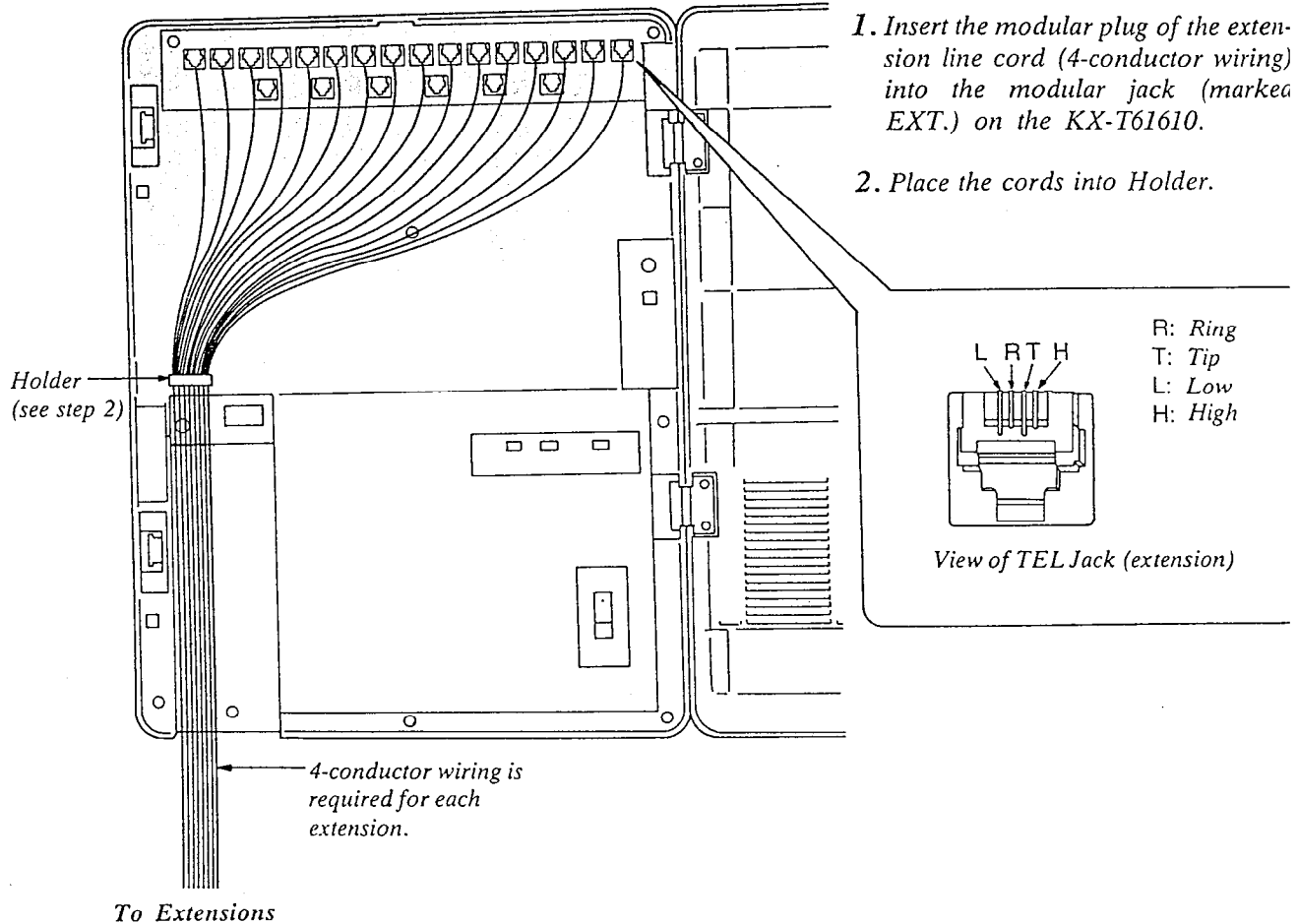

- The inner 2 wires (red, green) are for Tip and Ring and the outer 2 wires (black and yellow) are for Low and Hi (DATA).
- The max. length of the extension line cord that connects the KX-T61610 and the extension is shown below
 - 26 AWG: Under 460 feet
 - 24 AWG: Under 750 feet
 - 22 AWG: Under 1180 feet

Caution

Mis-connection may cause the KX-T61610 to operate improperly. See "During Installation" page 6-1 and "During Connection" page 6-2 before connecting.

Connection of a Standard Telephone to Extensions

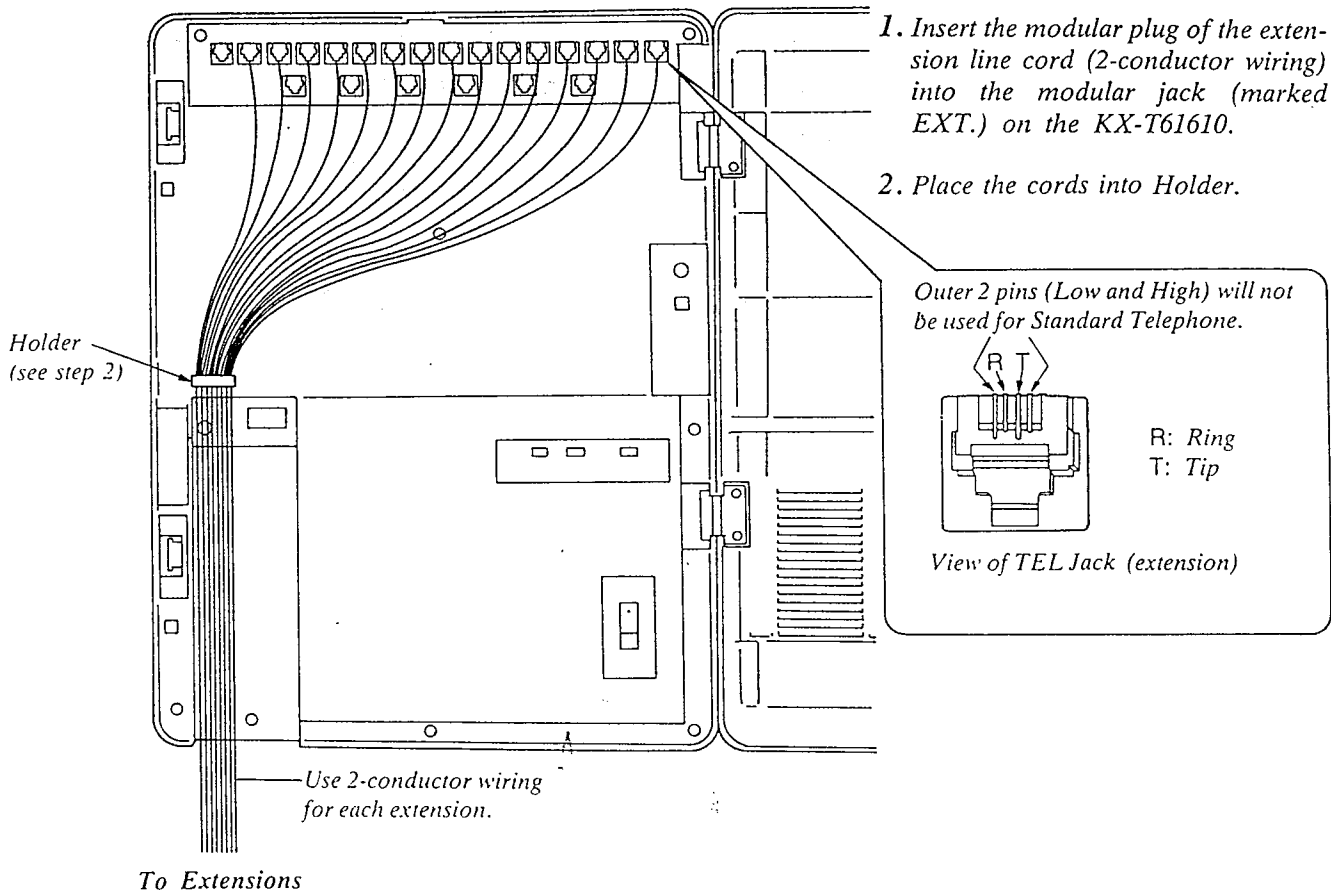

- The max. length of the extension line cord that connects the KX-T61610 and the extension is shown below.
 26 AWG: Under 2290 feet
 24 AWG: Under 3700 feet
 22 AWG: Under 5900 feet
- If a telephone or answering machine with an A-A1 relay is connected to the KX-T61610, set the A-A1 relay switch of the telephone or answering machine to OFF.

Caution

Mis-connection may cause the KX-T61610 to operate improperly.

See "During Installation" page 6-1 and "During Connection" page 6-2 before connecting.

Connection of The DSS Console (KX-T61640) to an Extension

Pair Telephone

The DSS Console, KX-T61640 needs its Pair Telephone (EMSS Proprietary Telephone) for the operation, because the DSS console cannot work by itself.

The EMSS Proprietary Telephone (such as KX-T61620, KX-T61630, KX-T61650, KX-T30820, KX-T30830, KX-T30850) is required as a pair telephone for dialing, storing, etc.

Place the KX-T61640 and the pair telephone side by side on your desk.

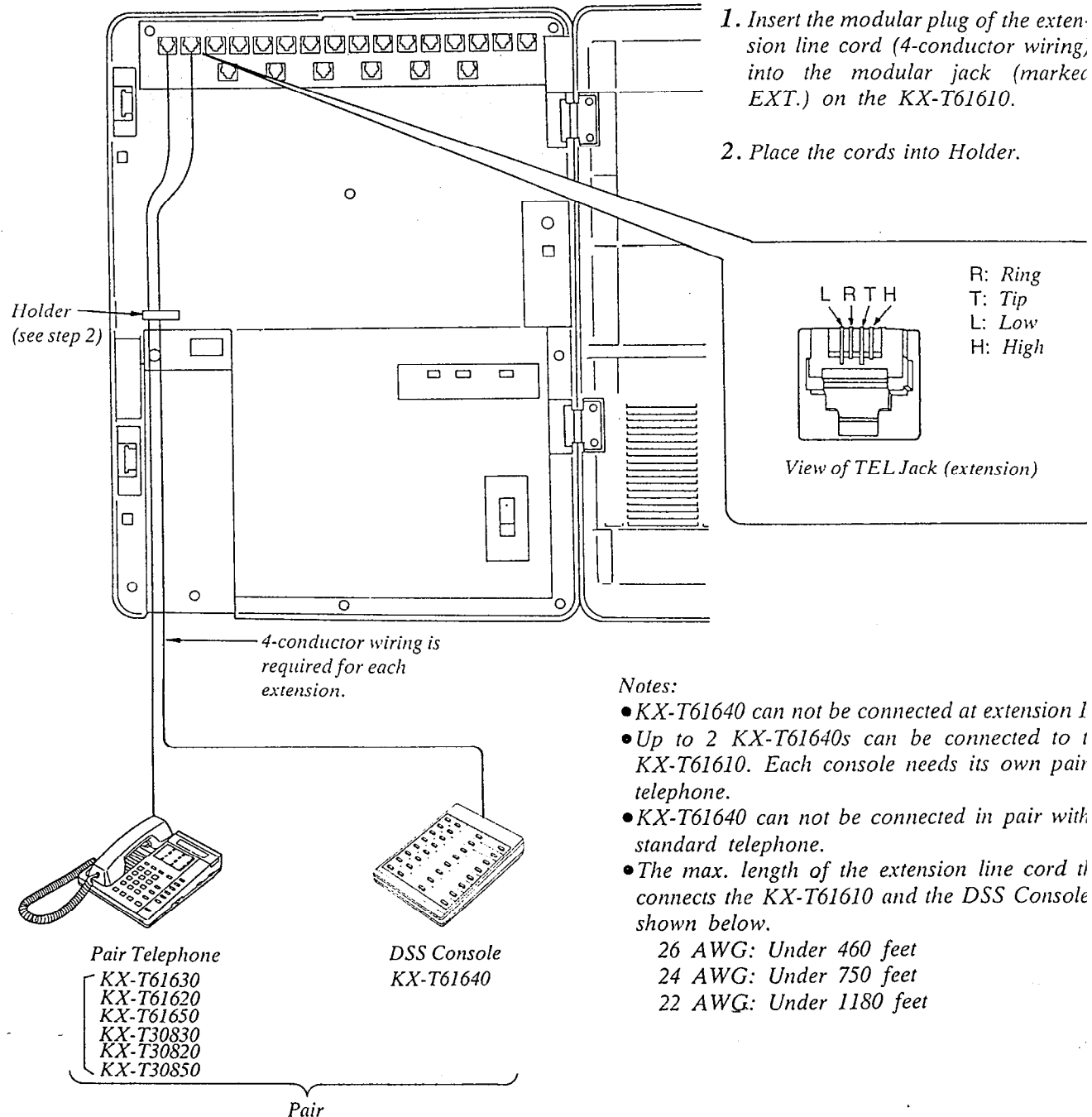

Caution

Mis-connection may cause the KX-T61610 to operate improperly. See "During Installation" page 6-1 and "During Connection" page 6-2 before connecting.

Example:

If your secretary has KX-T61630 at extension 12 and is to use the DSS console (KX-T61640), the console should be connected to extension 13.
(Paired extension is ext. 12).

1. Connect the KX-T61630 at extension 12.
2. Connect the KX-T61640 at extension 13.

• For use the KX-T61640, program should be done. Refer to "DSS Console Assignment" page 3-8.

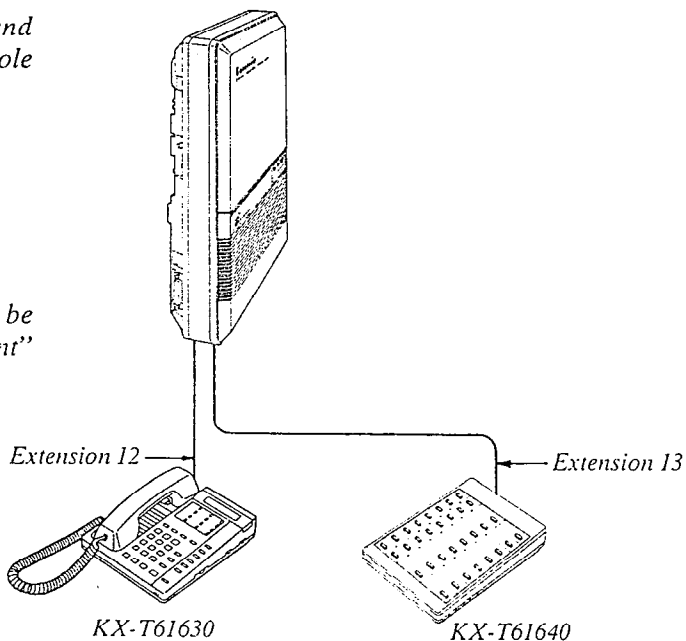

To Use Full Extensions When the DSS Console is Connected

- KX-T61610 has 16 extensions. But the DSS Console, KX-T61640 occupies one of the extensions, which can not make or receive a call. To use the full extensions, connect a standard telephone (EMSS Proprietary Telephone is not available) to the extension to which the KX-T61640 is connected.
- The standard telephone connected in parallel with KX-T61640 can be used without any affection of KX-T61640. The operation has no concern between KX-T61640 and the standard telephone.

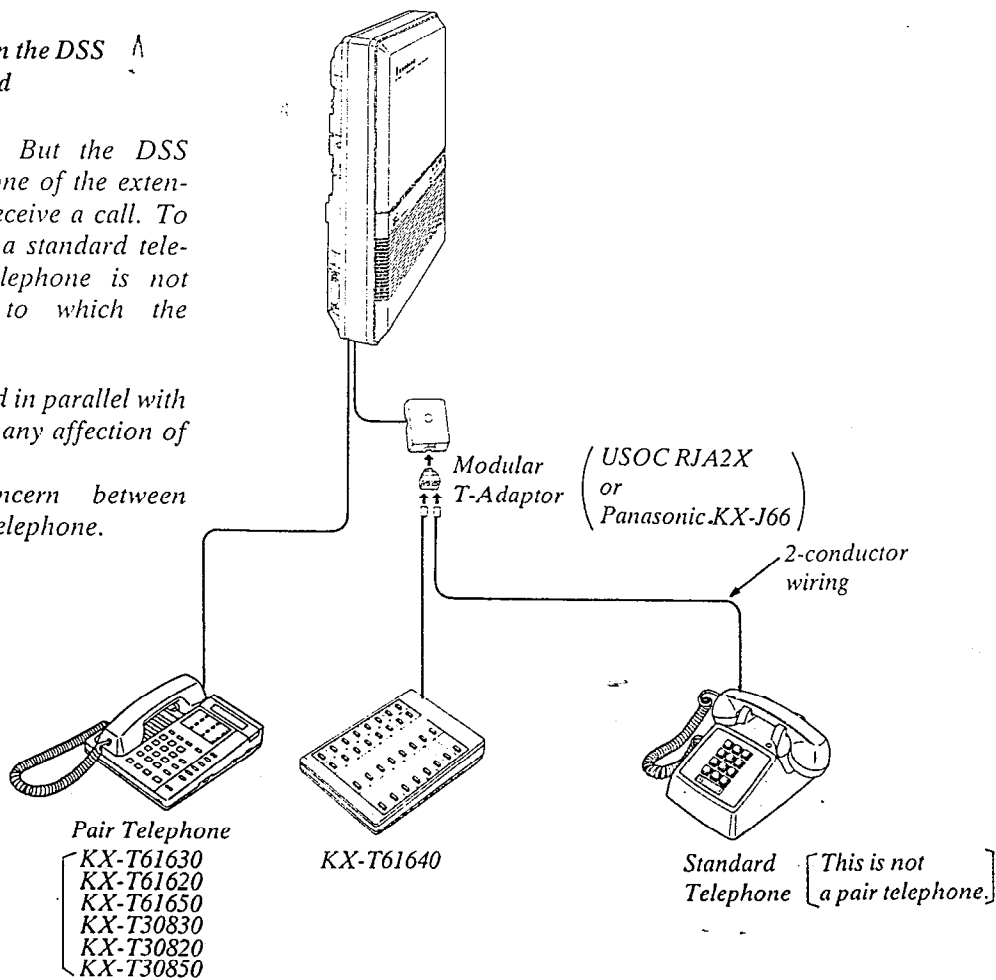

External Music Source

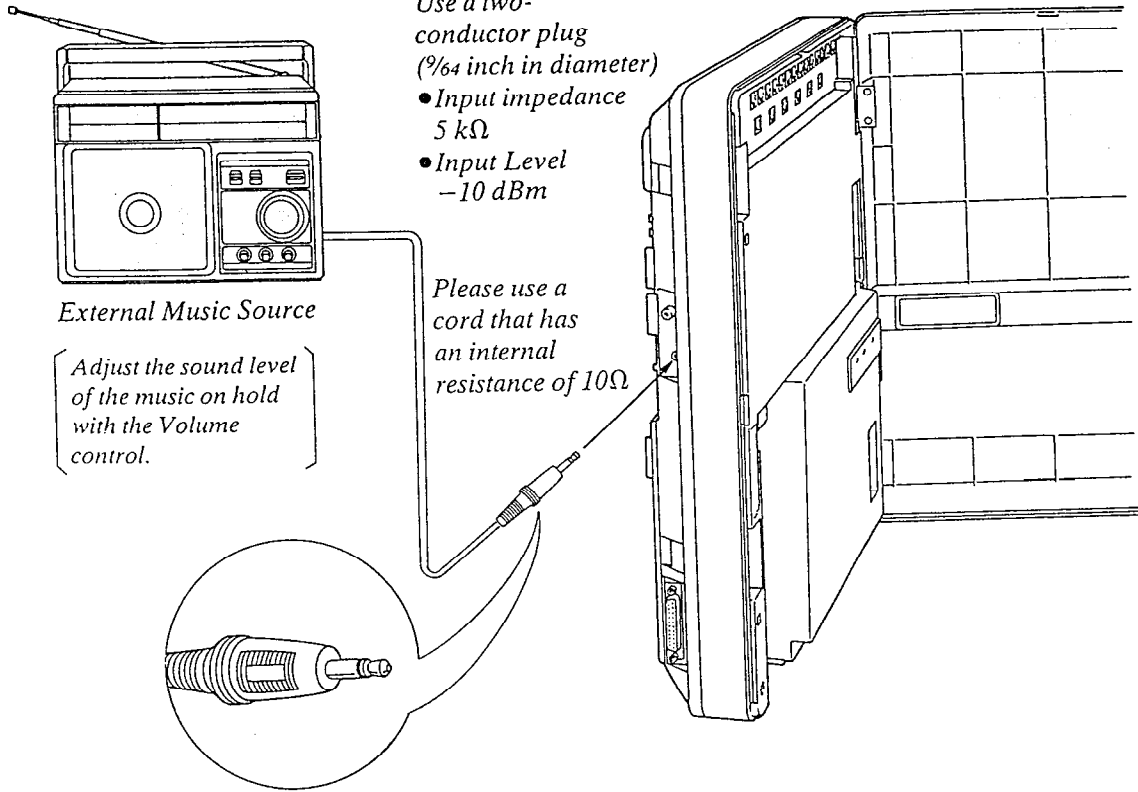

Paging Equipment

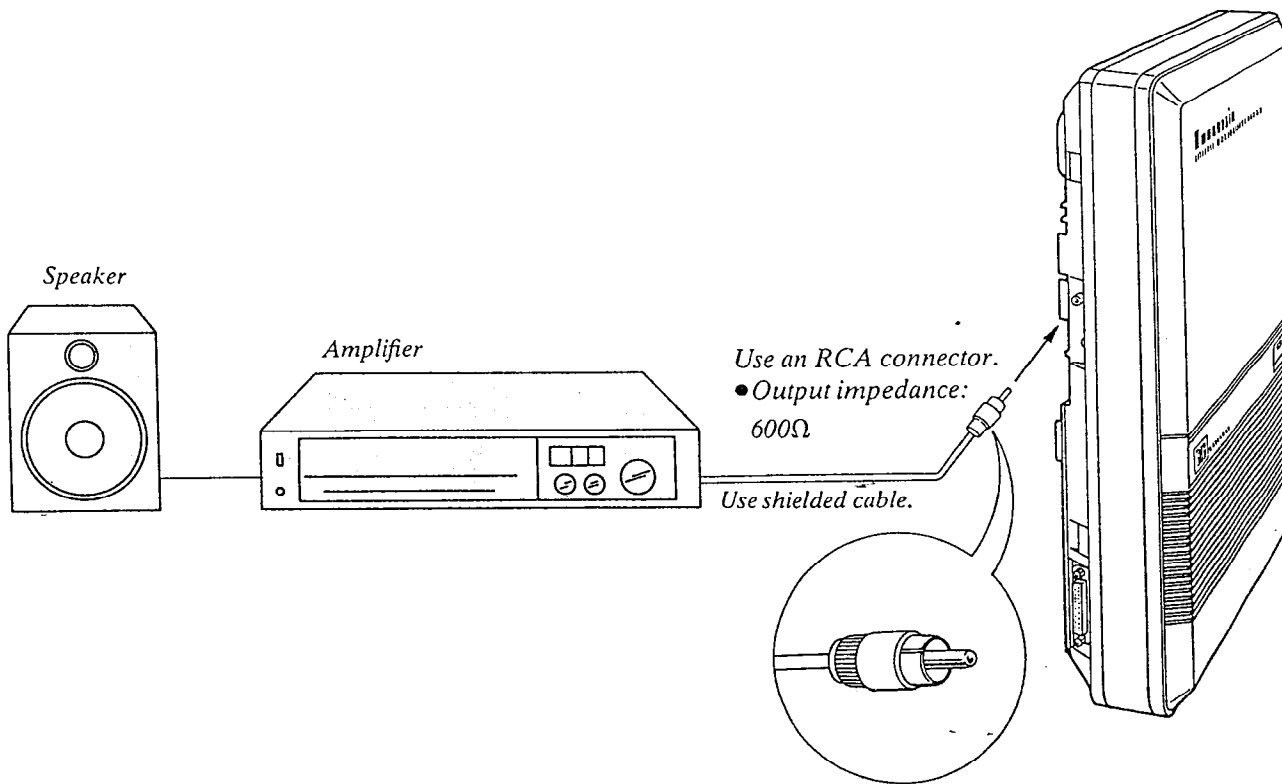

Connection of The Optional Doorphone (KX-T30865)

For installing the doorphone, use the Optional Doorphone Adaptor (Use the KX-T30860D only).

1. How to install the Doorphone Adaptor to the KX-T61610

- ① Insert the adaptor projections to the holes.

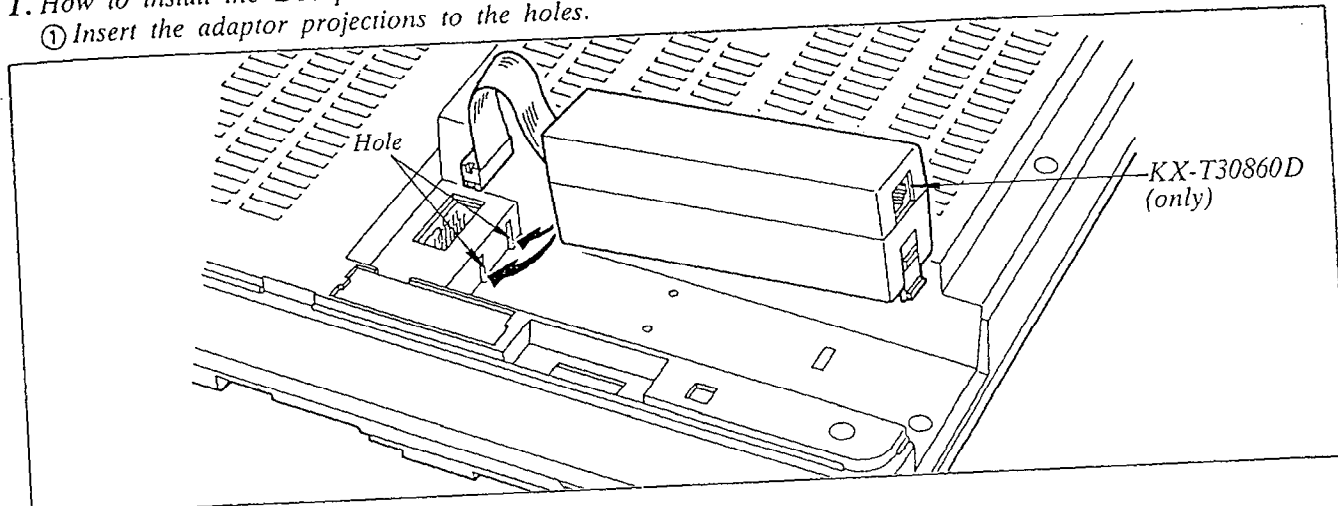

- ② Push the adaptor down so that it locks into the ribs of the unit.

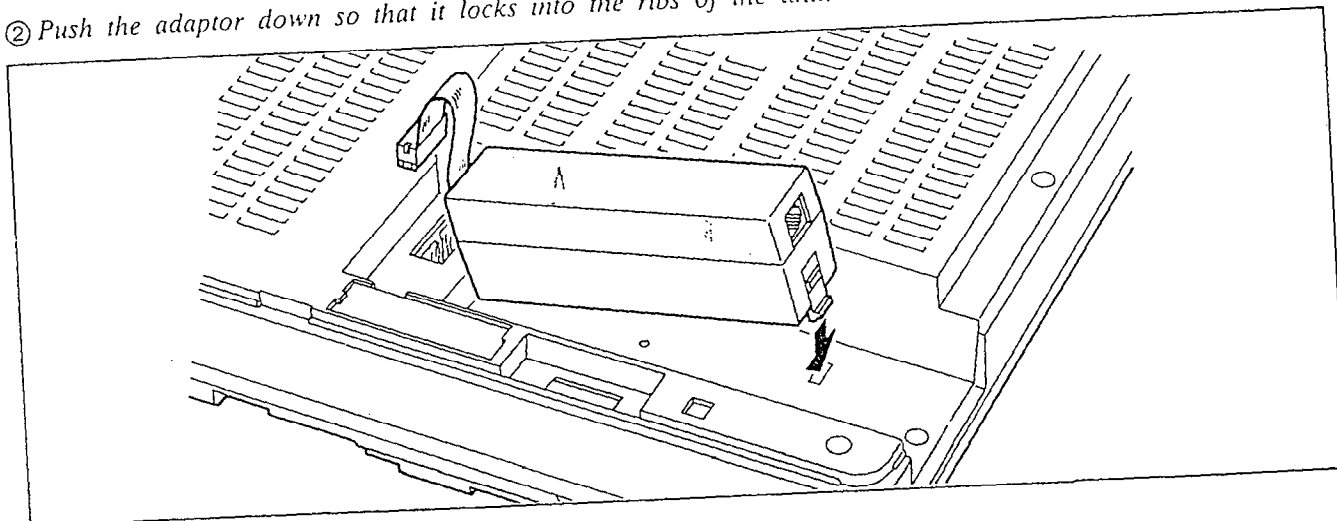

- ③ Insert the adaptor connector.

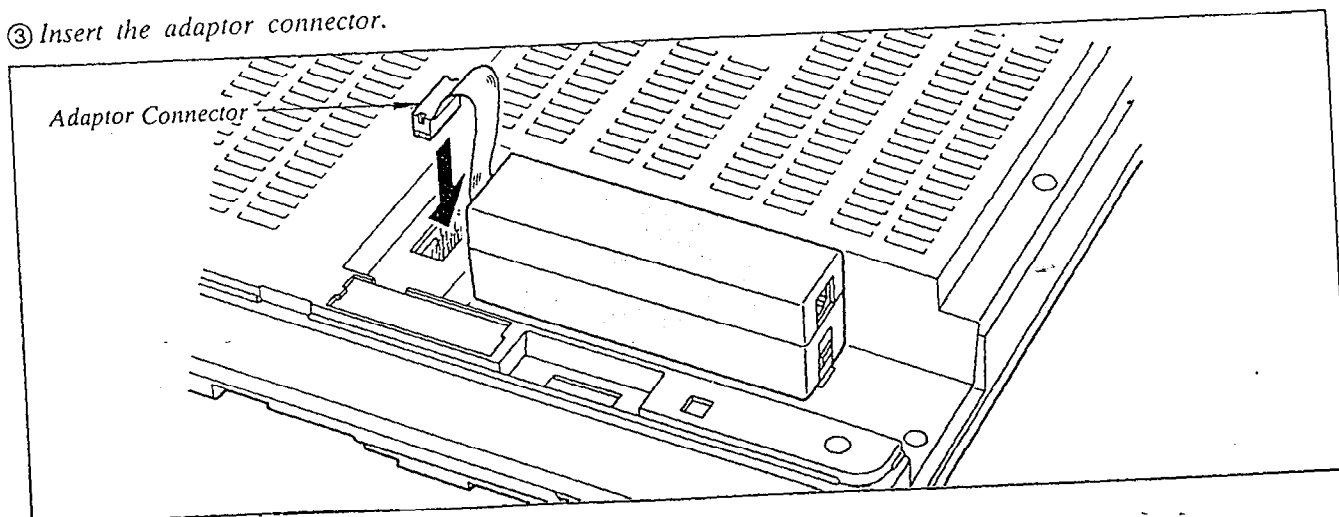

2. Wiring connection of the Doorphone

- (A) Connect the doorphone adaptor to the terminal box using a 4-conductor modular connector.
- (B) Connect the wires of doorphone 1 to the red and green screws of the terminal box.
- (C) Connect the wires of doorphone 2 to the yellow and black screws of the terminal box.

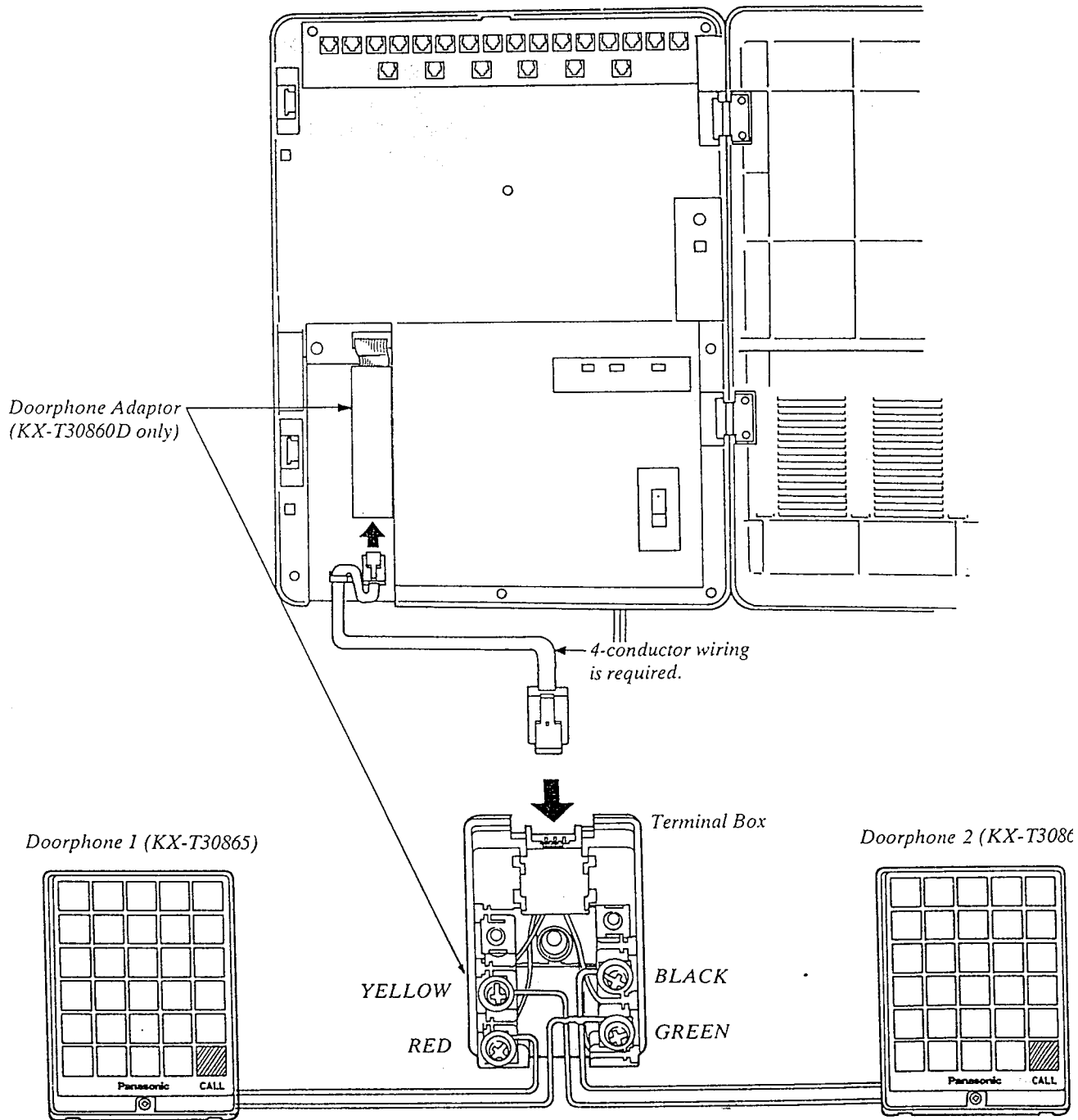

• The max. length of the telephone line cord that connects the KX-T61610 and the doorphone (KX-T30865) is shown below.

26 AWG: Under 230 feet
24 AWG: Under 370 feet
22 AWG: Under 590 feet

To Connect a Polarity Sensitive Telephone

If the telephone you are using with the KX-T61610 is polarity sensitive.

1. Connect all extension wiring to the KX-T61610.

2. Confirm that dialing can be done from all the extensions using a tone telephone.

3. If a dialing can not be done, the polarity between the extension and the KX-T61610 must be reversed.

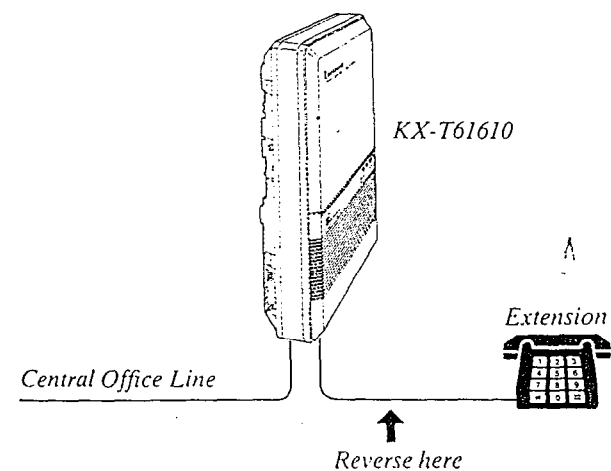

4. Set the Power Switch on the KX-T61610 to the OFF position.

5. Connect all Central Office (CO) Lines.

6. Confirm that dialing can be done on following extensions using a tone telephone.

Extension 11...CO 1
Extension 12...CO 2
Extension 13...CO 3
Extension 14...CO 4
Extension 15...CO 5
Extension 16...CO 6

7. If dialing can not be done, the polarity between the KX-T61610 and the Central Office Line must be reversed.

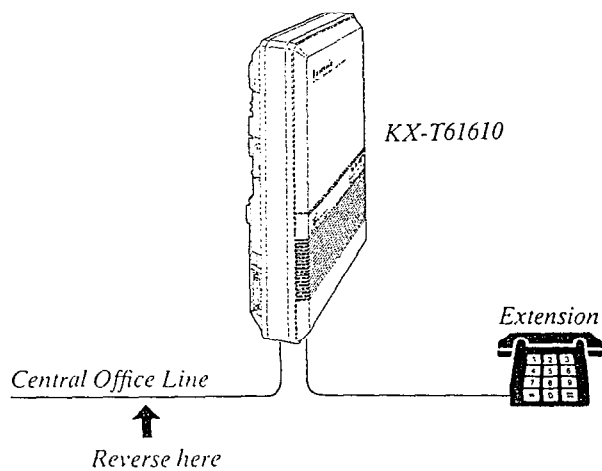

8. If any extension is changed or replaced, repeat these procedures (from step 1 through step 7).

To Connect Optional System Back-up Unit (KX-A16)

1. Connect the cord from the optional KX-A16 to the KX-T61610.
2. Plug in the AC power cord from the KX-A16.
3. Turn on the Power Switch located on the KX-A16.
 - Approximately 24 hours are required to recharge the KX-A16.
 - The KX-A16 will work for approximately 4 hours (on the average) in the event of a power failure.

- The Battery life is 3 years.
- A simple way to check the KX-A16 is to disconnect the KX-T61610 and the KX-A16 from the AC outlets, and then observe if the KX-T61610 operates.
- If the KX-T61610 does not operate, recharge the KX-A16.
- AC Primary Fuse, (250 V, 1.25 A)×1:
Replace the fuse which is in the fuse hold located on the rear, if the CHARGE Indicator is off.

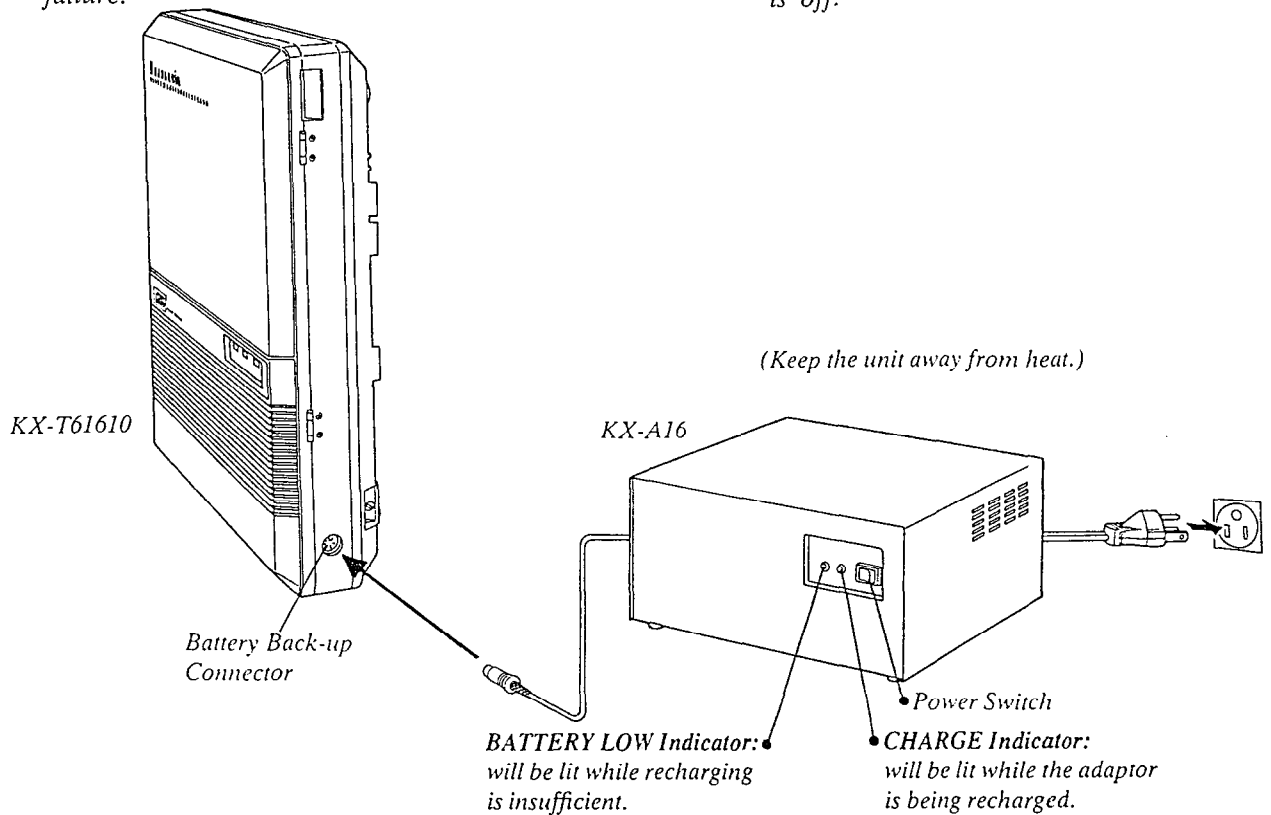

To Connect Printer

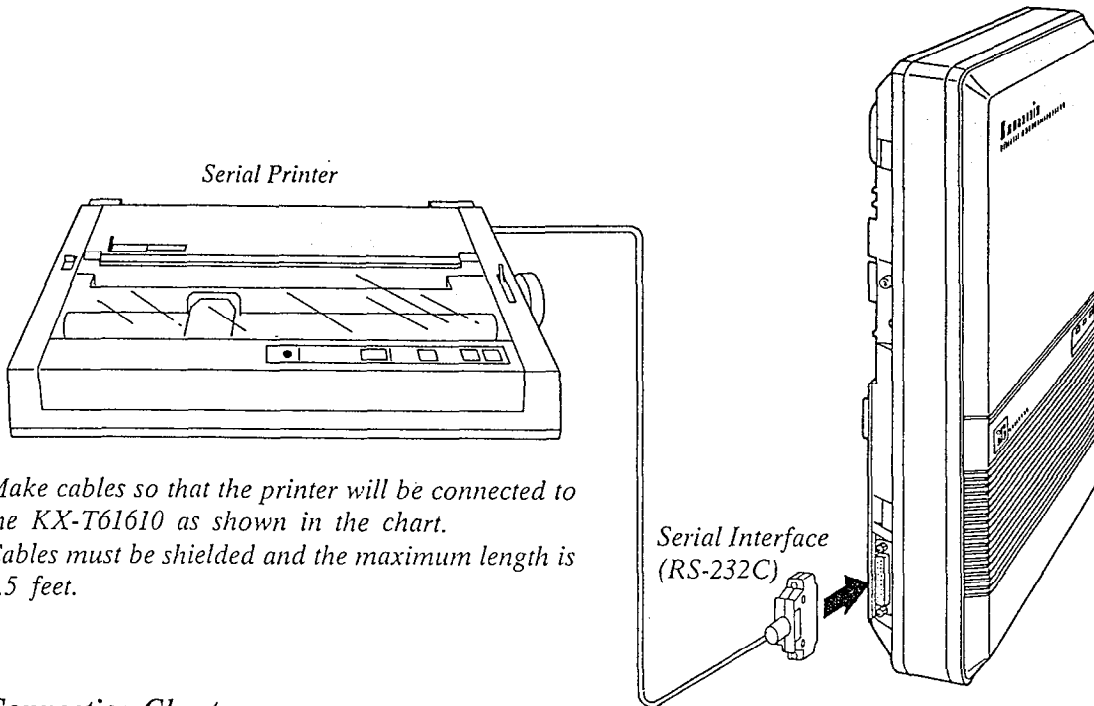

Make cables so that the printer will be connected to the KX-T61610 as shown in the chart. Cables must be shielded and the maximum length is 6.5 feet.

Connection Chart:

KX-T61610 RS-232C			Printer RS-232C		
Circuit Type (EIA)	Signal Name	Pin No.	Pin. No.	Signal Name	Circuit Type (EIA)
AA	FG	1	1	FG	AA
BA	TXD	2	3	RXD	BB
BB	RXD	3	2	TXD	BA
CB	CTS	5			
CC	DSR	6	20	DTR	CD
AB	SG	7	7	SG	AB
CD	DTR	20	5	CTS	CB
			6	DSR	CC
			8	DCD	CF

*Panasonic data terminal;

KX-D4910D, KX-D4911, KX-D4920, etc.
 If you connect this unit to a Panasonic Data Terminal, the Communication Parameter Transmit XON/XOFF on the Data Terminal must be set to the "YES" position.
 For further details, see the Operating Instructions of the Data Terminal.

When using special accessories such as cable, the user should use those specified in this installation manual to comply with the limits for a Class A computing device pursuant to Subpart J of Part 15 of FCC Rules.

PROGRAMMING

To activate this system, the requirements from telephone company and the customer must be programmed once the Power Switch has been turned on.

Programming Instructions

1. At extension 11:

All system programming changes (example: system clear, station program clear, toll restriction, hookswitch flash timing...) are done through extension 11.

• Extension 11 must always be a Panasonic model, KX-T61630.

2. System Program Switch setting:

The System Program Switch located on the KX-T61610 must be set to the PROGRAM position while making program changes. After all programming changes are completed, return the program switch to the SET position.

3. Overlay:

This overlay is used for programming the system and the program function names are inscribed on this card. Refer to page 3-2.

4. Before system programming, operate the system clear and station program clear to set to the default data of the programming.

A. System Clear:

1 Dial (99).

• "SYSTEM CLEAR" will be displayed.

2 Press the NEXT button.

• "ALL CLEAR?" will be displayed.

3 Press the MEMORY button to clear system.

4 To exit from system clear, press the END button.

The following features are preset as the default data.

Date and Time Setting

System Speed Dialing

CO Connection Assignment

Dial Mode (Tone/Pulse) Selection

Switching Mode (Day/Night Service)

Starting Time (Day/Night Service)

Flexible Day Outward Dialing Assignment

Flexible Night Outward Dialing Assignment

Flexible Day Ringing Assignment

Flexible Night Ringing Assignment

Toll Restriction—Class Assignment

Toll Restriction—Area Code Selection

Programmable Operator Call

Host PBX Access Codes Assignment

Automatic Answering (Automatic/Manual) Selection

Preferred CO Line Assignment

Programmable Call Waiting

Duration Time Count Start Mode

SMDR Communication Parameters

System Data Dump

SMDR Incoming/Outgoing Selection

Hookswitch Flash Timing

Disconnect Time

Calling Party Control (CPC) Signal

Intercom Alerting Mode

Programmable Doorphone

Dial Call Pickup Group Assignment

Account Code Input Mode

Delayed Ringing Assignment

Delayed Ringing Count Selection

DSS Console Assignment

Hold Time Reminder

Hold Recall Time Set

Programmable External Paging Access Tone

DTMF Receiver

Programmable Toll Prefix

Programmable Secret Speed Dial

Programmable Directory Assistance

DSS Button Mode

Transfer Recall Time

M3/FWD Selection

B. Station Program Clear:

1 Dial (98).

• "EXT CLEAR" will be displayed.

2 Press the NEXT button.

• "ALL CLEAR?" will be displayed.

3 Press the MEMORY button to clear the system.

4 To exit from station clear, press the END button.

The following features are preset as the default data.

One Touch Dialing

Background Music

Call-Forwarding

Data Line Security

Dial Call Pickup Deny

Do not Disturb

Auto CO Hunting

Pickup dial

Flexible CO Button

Flexible DSS Button

When the System Program Switch on the KX-T61610 is set to the PROGRAM position, the operation of the KX-T61630 will change as follows.

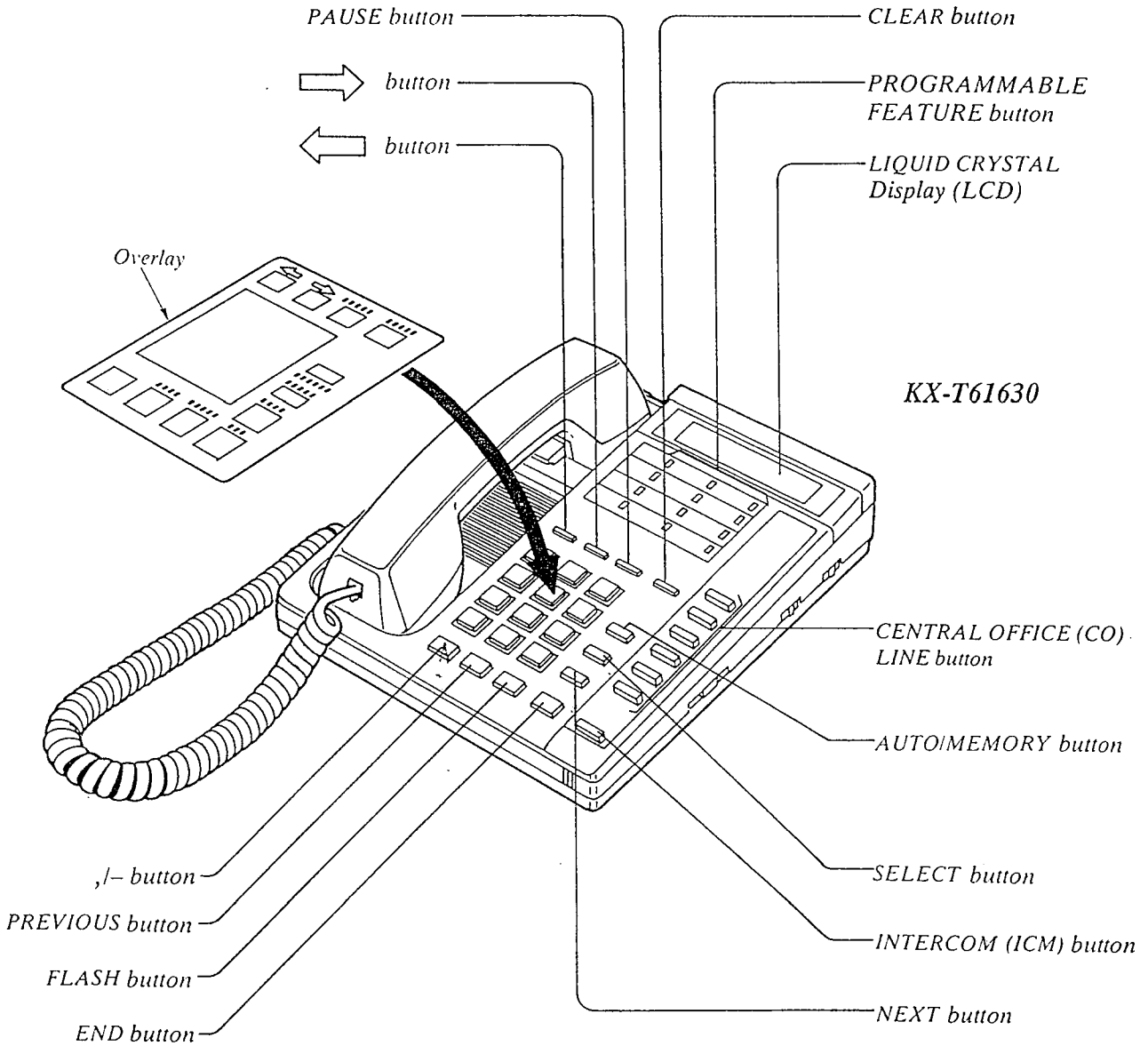

PROGRAMMING

Example of Programming

1. Turn the Power Switch to ON

2. Set the System Program Switch to PROGRAM
The LCD on the KX-T61630 will show "ENTER PGM CODE".

• Be sure the handset of extension 11 is in the cradle and the speakerphone button off.

3. To program automatic line access number 9 and the phone number 987-654-3210 speed access code 00. (Refer to page 3-5.)

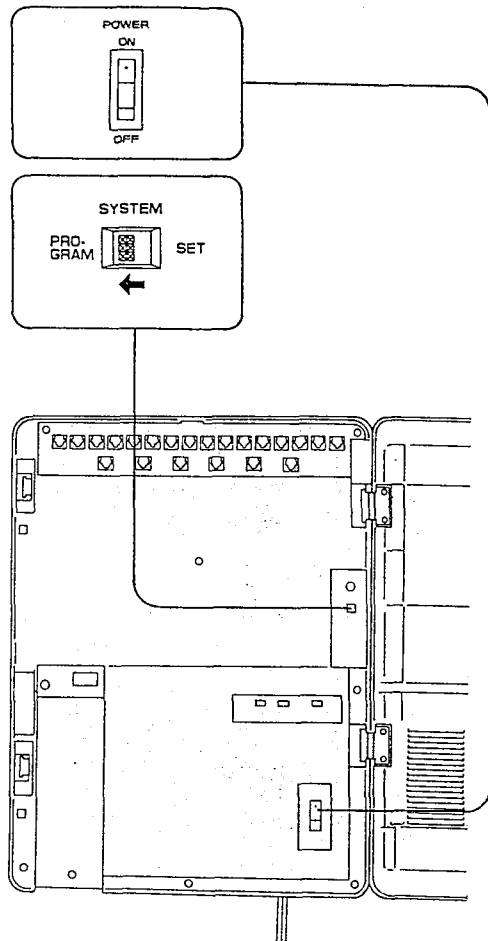

KX-T61630 at extension 11 (Extension 11 must be a KX-T61630.)	
1.	Dial (01) or press the AUTO button. Display SPEED DIALING
2.	Press the NEXT button. ENTER SPEED CODE
3.	Dial (00) or press the NEXT button. <ul style="list-style-type: none"> • If nothing is stored in access code "00", 00: NOT STORED • If already stored the automatic line access number 9 and the phone number 123-456-7890, 00: -123-456-7890
4.	① Dial "9". ② Press "—" button. ③ Dial "987". ④ Press "—" button. ⑤ Dial "654". ⑥ Press "—" button. ⑦ Dial "3210". 00: -987-654-3210
5.	Press the MEMORY button. 00: -987-654-3210
6.	<ul style="list-style-type: none"> • To program the next access code, press the NEXT button. • To program a desired access code, press the SELECT button and then dial the number.
7.	Repeat step 4 to 6.
8.	To return to the initial program mode, press the END button. ENTER PGM CODE

While programming if a mistake is made,

1. Press the "END" button.
2. Start programming procedure from the beginning.

- You will hear a beep after pressing the MEMORY button.
- The MEMORY indicator light will go on when the MEMORY button is pressed, and then the Indicator light will go out when the NEXT or PREV button is pressed.

4. Return the System Program Switch to SET
■ To make program change, start from the beginning.

Date and Time Setting

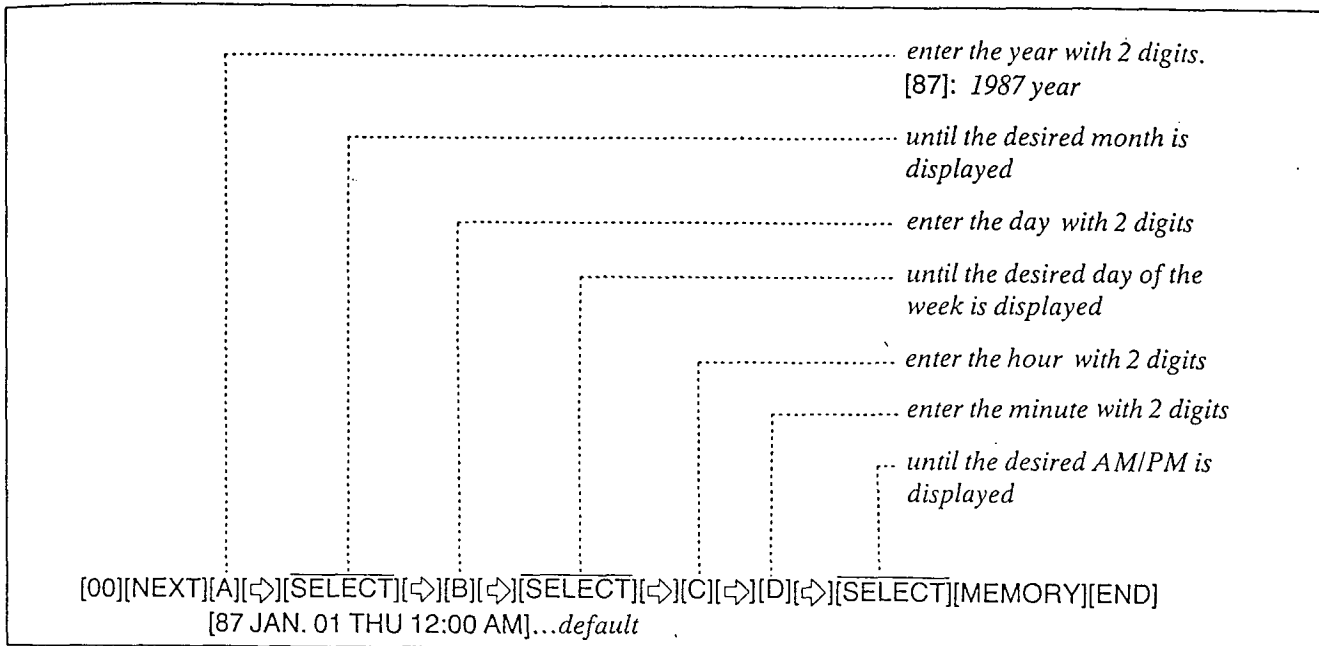

Description

Entry of the current day, date and time.

Programming

1. Dial (00).
"DAY/TIME SET" will be displayed.
2. Press the NEXT button.
"87 JAN. 01 THU" will be displayed and "87" will blink.
3. Enter the year (last 2 digits) using the dialing button.
4. Press the "<=>" button and then repeat pressing the SELECT button until the desired month is displayed.
5. Press the "<=>" button and then enter the day with 2 digits.
6. Press the "<=>" button and then repeat pressing the SELECT button until the desired day of the week is displayed.
7. Press the "<=>" button.
"12: 00 AM" will be displayed.
8. Enter the hour with 2 digits.
9. Press the "<=>" button and then enter the minute with 2 digits.
10. Press the "<=>" button and then repeat pressing the SELECT button until the desired AM/PM is displayed.
11. Press the MEMORY button.
12. To return to the initial program mode, press the END button.

Condition

- If "<=>" button is pressed, the display will return to the previous sequence in the programming step.
- Instantly after pressing the MEMORY button, the new time will start.
But the LCD of extension 11 will display the new time only after the System Program Switch is set to SET.

System Speed Dialing Entry

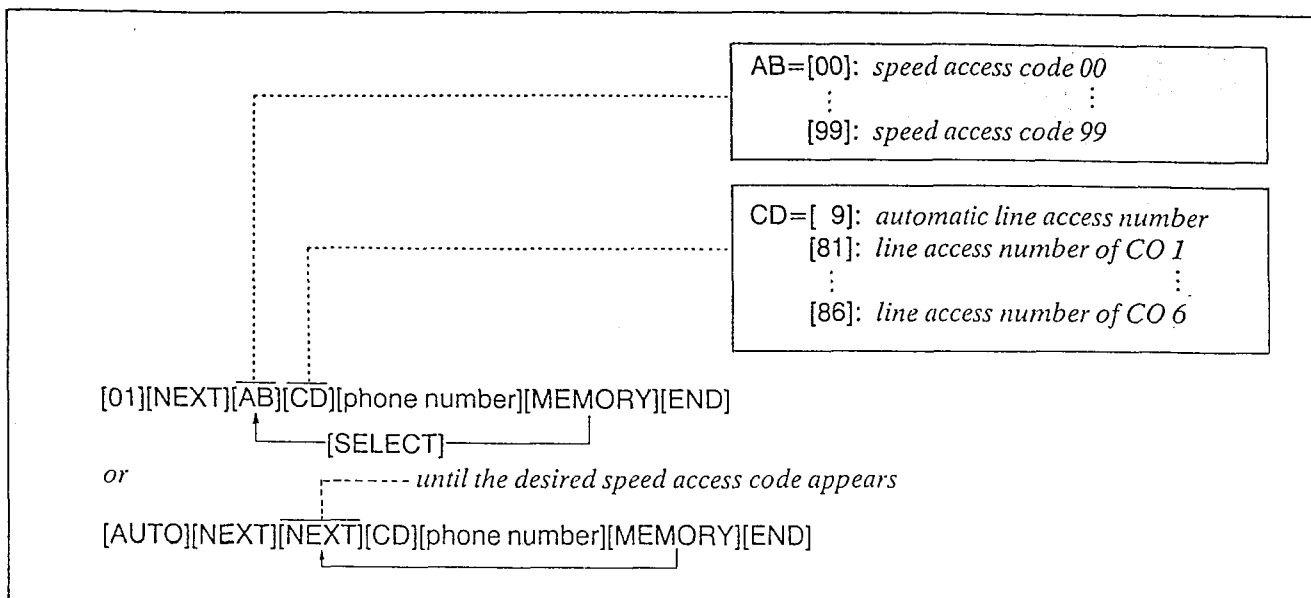

Description

100 phone numbers each with up to 32 digits may be entered into programming for speed dialing use from each extension.

Pushing the “*”, “#” “PAUSE”, “—” or “FLASH” button counts as 1 digit.

Programming

1. Dial (01) or press the AUTO button to go into the speed dialing entry mode.
“SPEED DIALING” will be displayed.
2. Press the NEXT button.
“ENTER SPEED CODE” will be displayed.
3. Dial (00 through 99) or press the NEXT button, for speed access code entry.
Example:
When dialing (00) or pressing the NEXT button.
 - The LCD will show “00:NOT STORED” when nothing is stored in speed access code “00”. When the automatic line access number 9 and the phone number 123-456-7890 has been stored, “00: -123-456-7890” will be displayed.

4. Enter the line access number.

9: for automatic selection
 81: for CO 1
 82: for CO 2
 83: for CO 3
 84: for CO 4
 85: for CO 5
 86: for CO 6

5. Enter the phone number.

- You may enter punctuations during a phone number.
- To erase a wrong entry, press the CLEAR button.

6. Press the MEMORY button.

- The memory indicator will be lit.

7. To program desired speed access code, press the SELECT button and then dial the speed access code.
To advance to the next speed access code, press the NEXT button.
To return to the previous speed access code, press the PREV button.

8. Repeat steps 4 to 7.

9. To exit from speed dialing entry, press the END button.

- The LCD will show the initial program mode, "ENTER PGM CODE".

To change

Repeat steps 1 to 9.

To erase after programming

1. Dial (01) or press the AUTO button.
"SPEED DIALING" will be displayed.
2. Press the NEXT button.
"ENTER SPEED CODE" will be displayed.
3. Dial (00 through 99) or press the ^ANEXT button, for speed access code entry.
The speed access code and the phone number will be displayed.
4. Press the CLEAR button.
5. Press the MEMORY button.
6. To program desired speed access code, press the SELECT button and then dial the speed access code.
To advance to the next speed access code, press the NEXT button.
To return to the previous speed access code, press the PREV button.
7. Repeat steps 4 to 6.
8. To exit from speed dialing entry, press the END button.

Conditions

- Use the "⇨", or "⇩" button for scrolling the display.
- The line access number (9 or 81 through 86) should be stored.
- When dialing, the pause is automatically entered after line access number (9 or 81 through 86).
- Continuous use of speed dialing is possible.

Example:

[AUTO] [01] [AUTO] [02]

In this case, speed access code "02" should not include the line access number.

There is a phone number directory on page 6-12.

Examples

1) To enter line access number 81 and telephone number 201-392-4669 into speed access code 00.

(01 NEXT 00 81- 201-392-4669 MEMORY END)

Speed access code: 00
 line access number: 81
 Telephone number: 201-392-4669

•If punctuations are not entered during a phone number, the LCD will show as below.
 (00: 812013924669)

2) To enter automatic line access number 9, account code 1234 and telephone number 201-392-4669 into speed access code 02.

(01 NEXT 02 9 * * 1234 201-392-4669 MEMORY END)

Speed access code: 02
 automatic line access number: 9
 account code: 1234
 Telephone number: 201-392-4669

•Refer to "Account code Input mode" pag 3-34 and "Account code" page 4-25.

3) To access MCI

(01 NEXT 01 9- 123-4567 PAUSE PAUSE 9876 201-348-7000 MEMORY END)

Speed access code: 01
 automatic line access number: 9
 MCI number: 123-4567
 PAUSE button: PAUSE PAUSE
 Security code: 9876
 Telephone number: 201-348-7000

4) To access ITT

(01 NEXT 02 81 765-4321 PAUSE PAUSE 201-348-7000 6789 MEMORY END)

Speed access code: 02
 Line access number: 81
 ITT number: 765-4321
 PAUSE button: PAUSE PAUSE
 Telephone number: 201-348-7000
 Security code: 6789

When required to change the dialing mode from the pulse mode to the tone mode. (See page 4-29)

(01 NEXT 02 82 765-4321 * # PAUSE PAUSE 201-348-7000 6789 MEMORY END)

pulse mode: 765-4321
 # button: #
 * button: *
 tone mode: 201-348-7000 6789

DSS Console Assignment

Console 1 extension number

AB=[12]: on extension 12
⋮
[26]: on extension 26

Telephone extension number
paired with console 1

CD=[11]: on extension 11
⋮
[26]: on extension 26

Console 2 extension number

EF=[12]: on extension 12
⋮
[26]: on extension 26

Telephone extension number
paired with console 2

GH=[11]: on extension 11
⋮
[26]: on extension 26

[02][NEXT][AB][↵][CD][↵][EF][↵][GH][MEMORY][END]

Description

If a DSS console is used the extension number paired with the DSS console should be assigned.

Programming

1. Dial (02)
"DSS CONSOLE SET" will be displayed.
2. Press the NEXT button.
The LCD will show "C . . - T . . ,
C . . - T . . " when nothing is stored.
When console 1 has been stored to extension 12, the pair telephone with the console 1 has been stored to extension 13, the console 2 has been stored to extension 14 and the pair telephone with console 2 has been stored to extension 15, "C12-T13, C14-T15" will be displayed.
3. Dial the extension number to which the console 1 is connected.
4. Press the " ⇨ " button.
5. Dial the extension number which is paired with the console 1.
 - If you don't connect the console 2, proceed to step 10.
6. Press the " ⇨ " button.
7. Dial the extension number to which the console 2 is connected.
8. Press the " ⇨ " button.
9. Dial the extension number which is paired with the console 2.
10. Press the MEMORY button.
11. To return to the initial program mode, press the END button.

Conditions

- DSS console can be connected up to two.
- DSS console can not be connected in pair with a standard telephone.
- DSS console can not be connected at extension 11.

Example:

If Mr Jay's secretary has KX-T61630 at extension 12 and is to use the DSS console (KX-T61640), the console should be connected to extension 13. (Paired extension is ext. 12.) Mr Brown's secretary has KX-T61620 at extension 14 and is to use the DSS console (KX-T61640), the console should be connected to extension 15. (Paired extension is ext. 14.)

```
[02][NEXT][13][⇨][12][⇨][15][⇨][14]
[MEMORY][END]
```

Programming Table

See page 6-14.

CO Connection Assignment

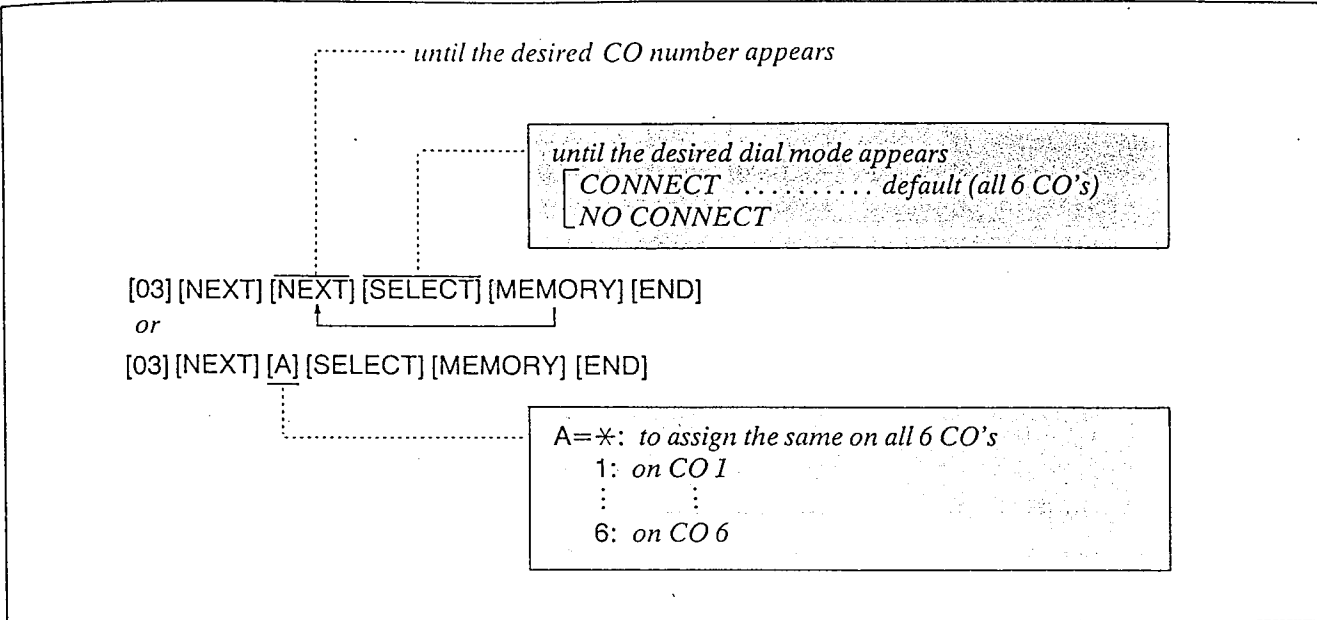

Description

You can program which outside line is connected and which one is not connected. When an extension automatically selects an idle outside line, the extension can be connected to it quickly.

Conditions

- When you start the programming from step 1, you may dial the desired CO number instead of the NEXT button at step 3.
- The PREV button allows you to see the entry status in the previous CO connection assignment.

Programming

1. Dial (03).
"CO CONNECTION" will be displayed.
2. Press the NEXT button.
"ENTER CO NO" will be displayed.
3. Press the NEXT button.
"CO 1: CONNECT" will be displayed and "CONNECT" will blink.
4. Press the SELECT button, to alternate between CONNECT and NO CONNECT to select the desired mode.
5. Press the MEMORY button.
The LCD will stop blinking.
6. Repeat steps 3 to 5, to program the dialing mode on the other CO lines.
7. To return to the initial program mode, press the END button.

Example:

CO 1 and 2 CONNECT
CO 3 NO CONNECT

1. [03] [NEXT] [(NEXT) or (1)] [MEMORY]
2. [NEXT] [MEMORY]
3. [NEXT] [SELECT] [MEMORY] [END]

Programming Table

See page 6-14.

Dial Mode (Tone/Pulse) Selection

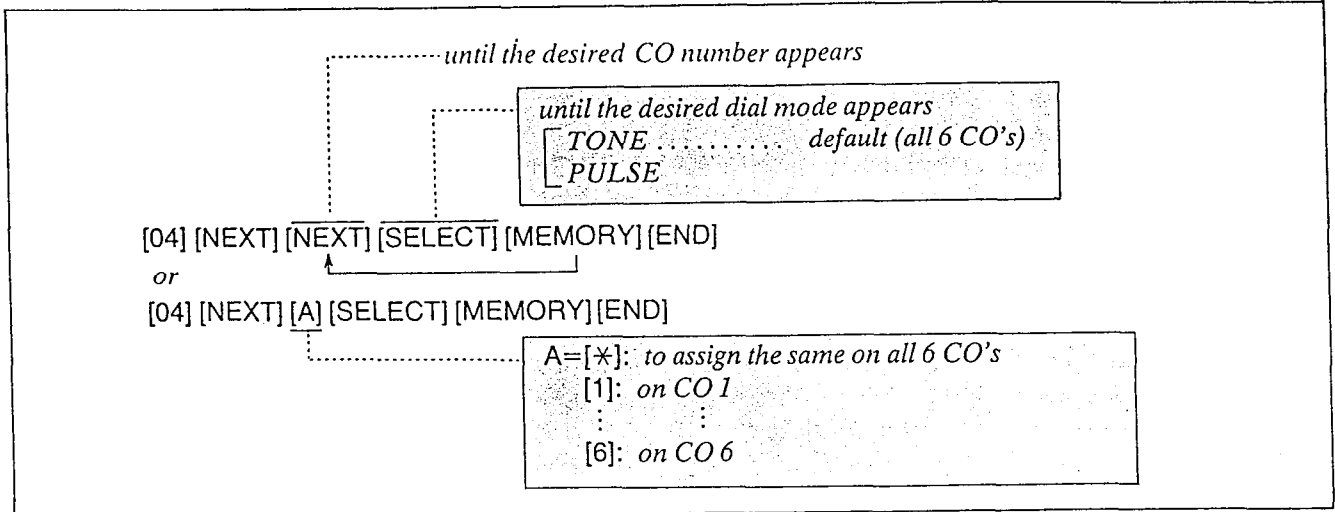

Description

Allows the user to select the dialing mode (tone or pulse) of each CO (Central Office) line.

•TONE Dial Mode

The dial signal from the extension (with tone or pulse dial mode) will be converted to TONE. TONE will then be transmitted to the Central Office.

•PULSE Dial Mode

The dial signal from the extension (with tone or pulse dial mode) will be converted to PULSE. PULSE will then be transmitted to the Central Office.

Programming

1. Dial (04).

"CO DIAL MODE" will be displayed.

2. Press the NEXT button.

"ENTER CO NO" will be displayed.

3. Press the NEXT button.

"CO 1: TONE" will be displayed and "TONE" will blink.

4. Press the SELECT button to alternate between TONE and PULSE.

5. Press the MEMORY button.

The LCD blinking will stop.

6. Repeat steps 3 to 5, to program the dialing mode on the other central office lines.

7. To return to the initial program mode, press the END button.

Conditions

- When you start the programming from step 1, you may dial the desired CO number instead of the NEXT button at step 3.
- The PREV button allows you to see the entry status in the previous CO dial mode.
- If the KX-T61610 is connected to the Central Office directly or installed behind a host PBX, which receives both tone and pulse dialing mode, the KX-T61610 must be used only in the tone dial mode.
- If your extension is not a KX-T61630, KX-T61620, KX-T61650, KX-T30830, KX-T30820 or KX-T30850 but a standard telephone, and the dial tone frequency of CO Lines is 600 Hz, the KX-T61610 must be used only for the pulse dial mode of CO Lines.

Example:

- TONE on the CO 1=

[04] [NEXT] [1] [MEMORY] [END]

or

[04] [NEXT] [NEXT] [MEMORY] [END]

- PULSE on the CO 2=

[04] [NEXT] [2] [SELECT] [MEMORY] [END]

or

[04] [NEXT] [NEXT] [NEXT] [SELECT] [MEMORY] [END]

Programming Table

See page 6-14.

Switching Mode (Day/Night Service)

until the desired mode appears
[MAN default
[AUTO

[05] [NEXT] [SELECT] [MEMORY] [END]

Description

Allows Day/Night service to be selected manually or automatically.

In case of manual switching, refer to "Flexible Night Service" page 4-39.

In case of automatic switching, set the "Starting Time (Day/Night Service)" page 3-13.

The following features should be set.

- "Flexible Day Outward Dialing Assignment" page 3-15.
- "Flexible Night Outward Dialing Assignment" page 3-16.
- "Flexible Day Ringing Assignment" page 3-17.
- "Flexible Night Ringing Assignment" page 3-18.

Programming

1. Dial (05).
"DAY/NIGHT MODE" will be displayed.
2. Press the NEXT button.
"MODE CHANGE:MAN" will be displayed and "MAN" will blink.
3. Press the SELECT button to alternate between "MAN" and "AUTO" to select the desired mode.
4. Press the MEMORY button.
The LCD will stop blinking.
5. To return to the initial program mode, press the END button.

Conditions

When the Switching mode (Day/Night Service) is set to "AUTO", the present Day/Night Service mode will not change after you finish programming. To change the present mode, manual operation is required.

After you selected the Starting time (Day/Night Service) page 3-13, select the present Day/Night mode by "Flexible Night Service" page 4-39.

Programming Table

See page 6-14.

Starting Time (Day/Night Service)

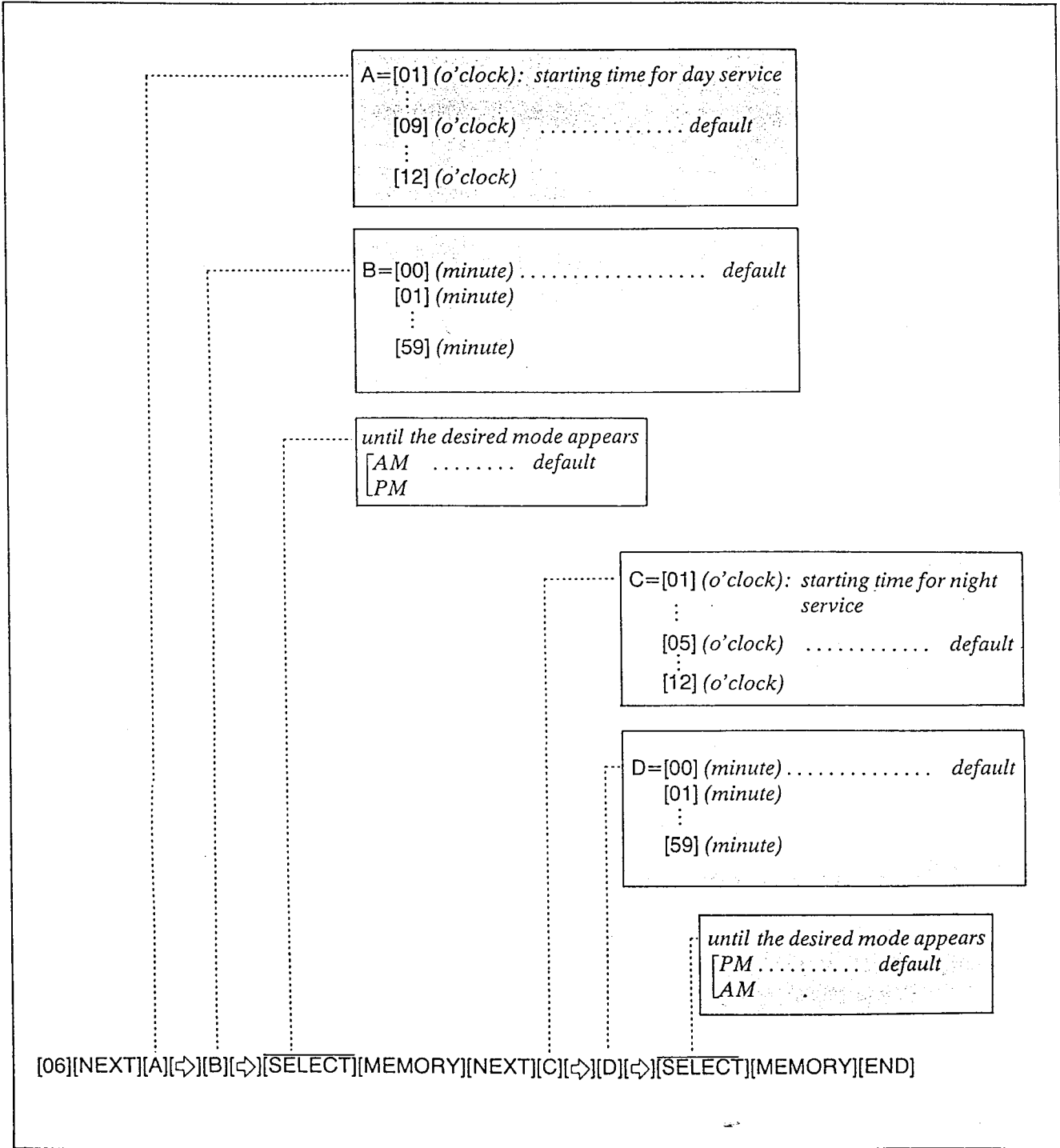

Description

If you select the automatic switching mode for day/night service, enter the starting time. Refer to "Switching Mode (Day/Night Service)" page 3-12.

Programming

1. Dial (06).
"DAY/NIGHT TIME" will be displayed.
2. Press the NEXT button.
"DAY: 09:00 AM" will be displayed as a default value and "09" will blink.
3. Enter the starting time for day service using 2 digits.
4. Press the "⇨" button.
"00" will blink.
5. Enter the minute using 2 digits.
6. Press the "⇨" button.
"AM" will blink.
7. Press the SELECT button to alternate between "AM" and "PM" to select the correct setting.
8. Press the MEMORY button.
9. Press the NEXT button.
"NIGHT: 05:00 PM" will be displayed as a default value and "05" will blink.
10. Enter the starting time for night service using 2 digits.
11. Press the "⇨" button.
"00" will blink.
12. Enter the minute using 2 digits.
13. Press the "⇨" button.
"PM" will blink.
14. Press the SELECT button to alternate between "AM" and "PM" to select the correct setting.
15. Press the MEMORY button.
16. To return to the initial program mode, press the END button.

Conditions

- If the NEXT button is pressed at step 3 through 7, the display will advance to the "Night Time input" mode (step 9). The operations of step 3 through 7 are not stored.
- If the PREV button is pressed at step 10 through 14, the display will return to the "day time input" mode (step 2). The operations of step 10 through 14 are not stored.

Example:

8:30 AM... starting time for day plan
6:30 PM... starting time for night plan

```
[06][NEXT][08][⇨][30][⇨][MEMORY][NEXT][06]
[⇨][30][⇨][MEMORY][END]
```

Programming Table

See page 6-14.

Flexible Day Outward Dialing Assignment

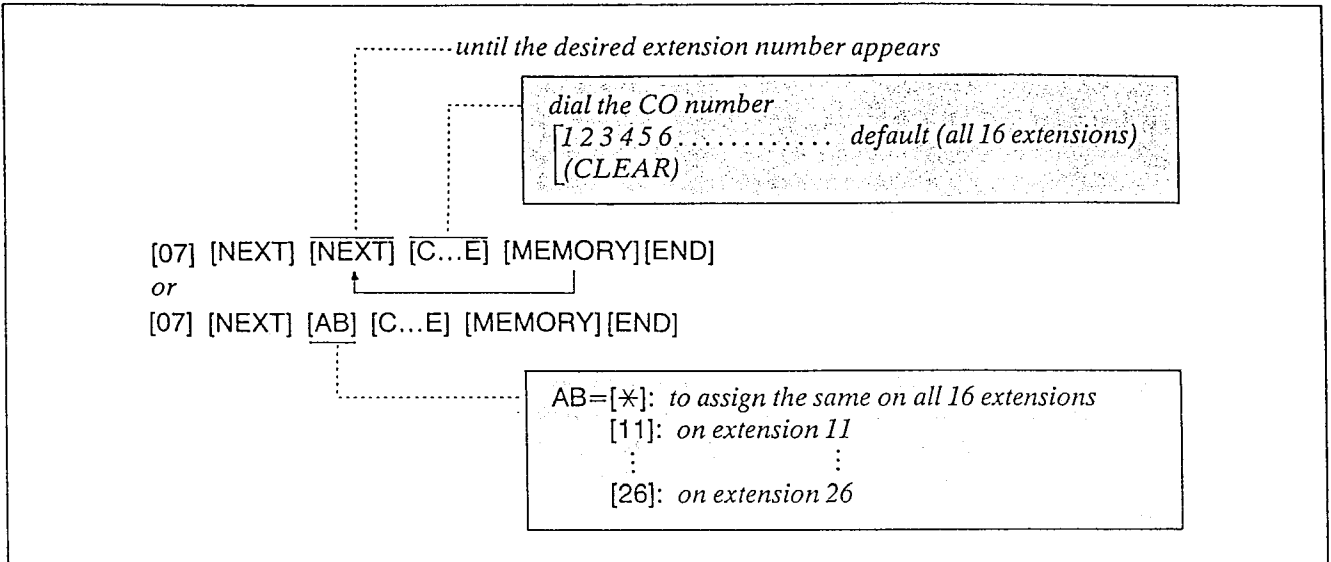

Description

Through programming, you can select which extensions may be used for outward dialing by using the day mode of operation.

Programming

1. Dial (07).
"DAY: OUT CO" will be displayed.
2. Press the NEXT button.
"ENTER EXT NO" will be displayed.
3. Press the NEXT button.
"11: CO 1 2 3 4 5 6" will be displayed and "1 2 3 4 5 6" will blink.
4. Dial the CO number to be entered.
The desired combination of CO lines will be displayed.
 [To prohibit dialing, press the CLEAR button instead of the CO number.
 "11: CO....." will be displayed.
5. Press the MEMORY button.
The LCD will stop blinking.
6. Repeat steps 3 to 5, to program the assignment on the other extensions.
7. To return to the initial program mode, press the END button.

Conditions

- When you start the programming from step 1, you may dial the desired extension number instead of the NEXT button at step 3.
- The PREV button allows you to go to the previous extension for displaying the CO assignment.

Example: COMPANY XYZ

Company XYZ wants only extension 11 and 15 to have access to CO 1, 2 and 3 on outgoing calls during the day. Extensions 12, 13, 14, 16, 17 and 18 are to be programmed for access to only CO 1 and 2.

1. [07] [NEXT] [(NEXT) or (11)] [1] [2] [3] [MEMORY]
2. [NEXT] [1] [2] [MEMORY]
3. [NEXT] [1] [2] [MEMORY]
4. [NEXT] [1] [2] [MEMORY]
5. [NEXT] [1] [2] [3] [MEMORY]
6. [NEXT] [1] [2] [MEMORY]
7. [NEXT] [1] [2] [MEMORY]
8. [NEXT] [1] [2] [MEMORY] [END]

Programming Table

See page 6-15.

Flexible Night Outward Dialing Assignment

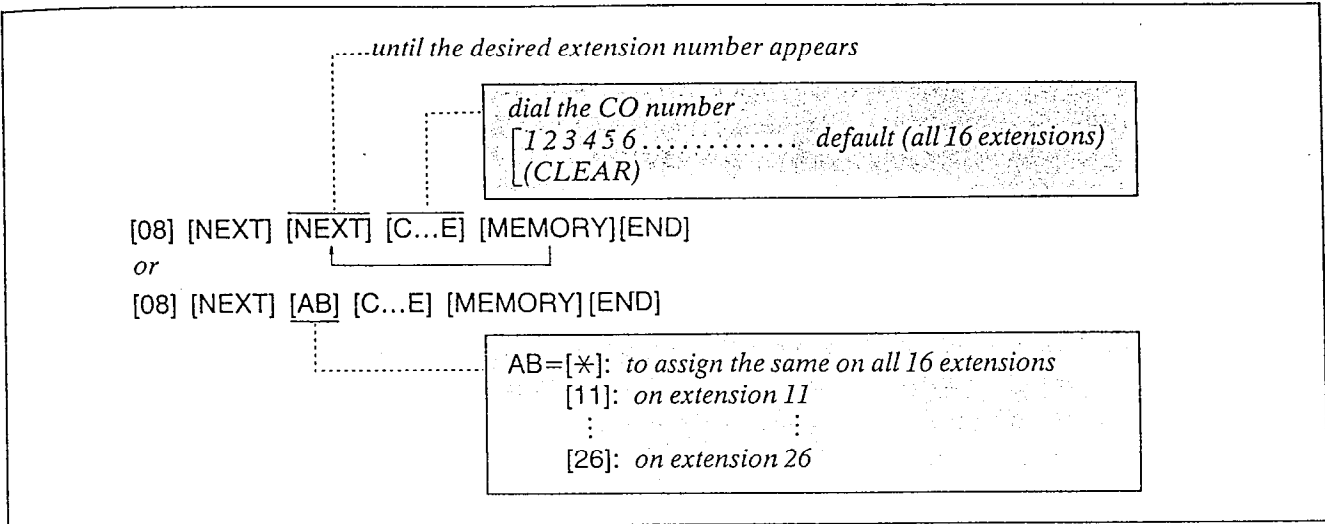

Description

Through programming, you can select of which extensions may be used for outward dialing by using the night mode of operation.

Programming

1. Dial (08).
"NIGHT: OUT CO" will be displayed.
2. Press the NEXT button.
"ENTER EXT NO." will be displayed.
3. Press the NEXT button.
"11: CO 1 2 3 4 5 6" will be displayed and "1 2 3 4 5 6" will blink.
4. Dial the CO numbers to be entered.
The desired combination of CO lines will be displayed.
[To prohibit dialing, press the CLEAR button instead of the CO number.
"11: CO....." will be displayed.
5. Press the MEMORY button.
The LCD will stop blinking.
6. Repeat steps 3 to 5, to program the assignment on the other extensions.
7. To return to the initial program mode, press the END button.

Conditions

- When you start the programming from step 1, you may dial the desired extension number instead of the NEXT button at step 3.
- The PREV button allows you to go to the previous extension for displaying the CO assignment.

Example: COMPANY XYZ

Company XYZ wants extensions 11, 13 and 16 to have access to CO 1, 2 and 3 on outgoing calls during the night. Extensions 12, 14, 15, 17 and 18 are to be programmed for access to only CO 1 and 2.

1. [08] [NEXT] [(NEXT) or (11)] [1] [2] [3] [MEMORY]
2. [NEXT] [1] [2] [MEMORY]
3. [NEXT] [1] [2] [3] [MEMORY]
4. [NEXT] [1] [2] [MEMORY]
5. [NEXT] [1] [2] [MEMORY]
6. [NEXT] [1] [2] [3] [MEMORY]
7. [NEXT] [1] [2] [MEMORY]
8. [NEXT] [1] [2] [MEMORY] [END]

Programming Table

See page 6-15.

Flexible Day Ringing Assignment

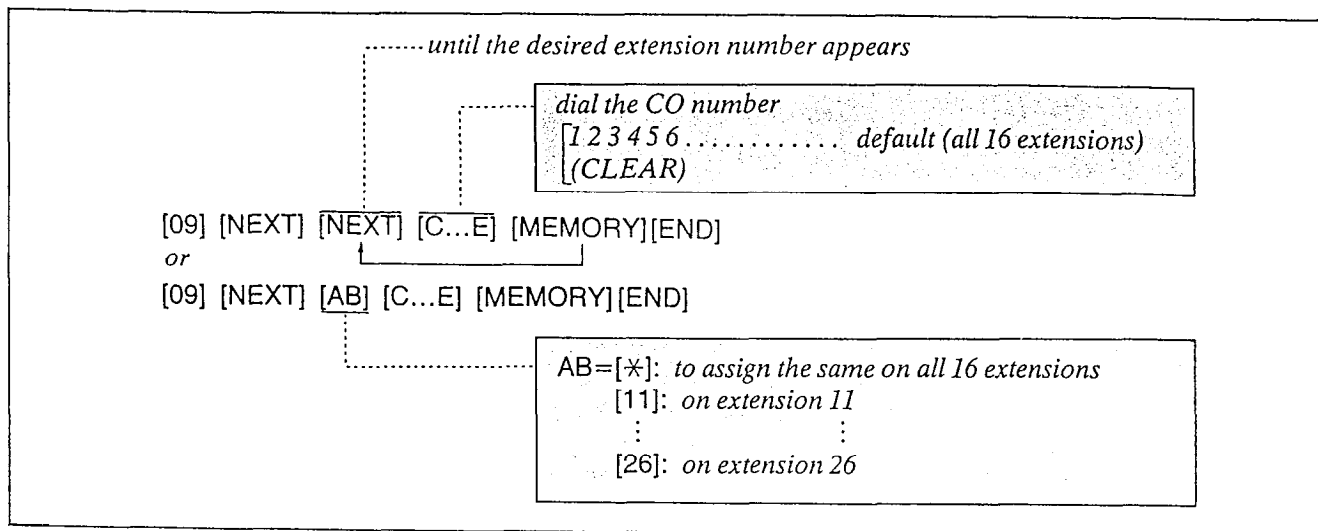

Description

Through programming, you can select which extensions will ring on incoming calls from the Central Office during the day time.

Programming

1. Dial (09).
"DAY: IN CO" will be displayed.
2. Press the NEXT button.
"ENTER EXT NO" will be displayed.
3. Press the NEXT button.
"11: CO 1 2 3 4 5 6" will be displayed and "1 2 3 4 5 6" will blink.
4. Dial the CO numbers to be entered.
The desired combination of CO lines will be displayed.

To prohibit ringing, press the CLEAR button instead of the CO number.
 "11: CO....." will be displayed.
5. Press the MEMORY button.
The LCD will stop blinking.
6. Repeat steps 3 to 5, to program the assignment on the other extensions.
7. To return to the initial program mode, press the END button.

Conditions

- When you start the programming from step 1, you may dial the desired extension number instead of the NEXT button at step 3.
- The PREV button allows you to go to the previous extension for displaying the CO assignment.

Example:

Incoming calls from Central Office during the day are programmed to ring at extension 11 only.

1. [09] [NEXT] [*] [CLEAR] [MEMORY]
2. [NEXT][1] [2] [3] [4] [5] [6]
[MEMORY] [END]

Programming Table

See page 6-15.

Flexible Night Ringing Assignment

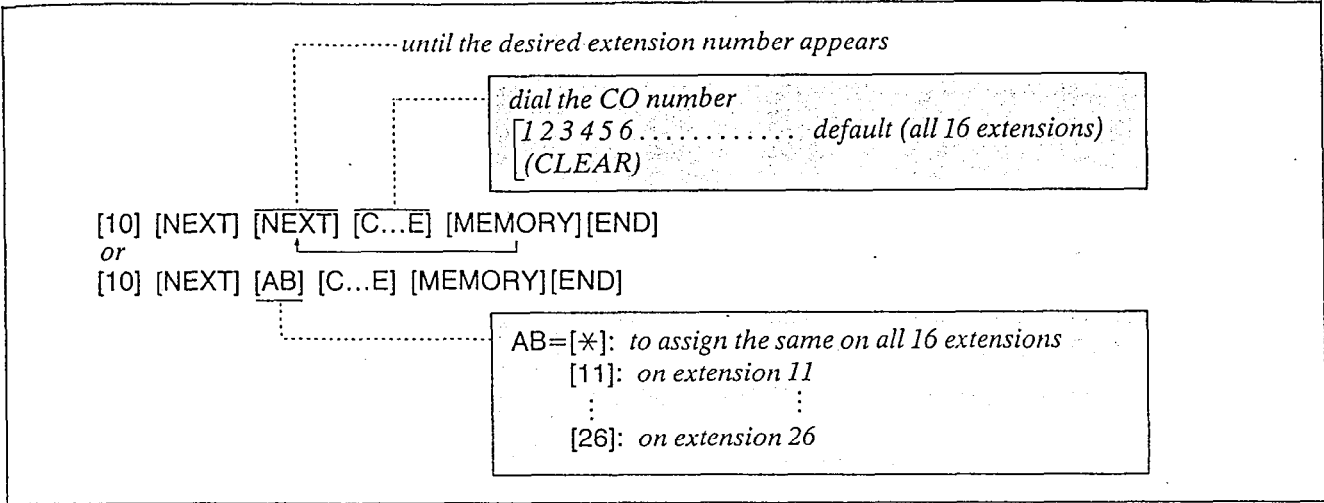

Description

Through programming, you can select which extensions will ring during the night time on incoming calls from the Central Office.

Programming

1. Dial (10).
"NIGHT: IN CO" will be displayed.
2. Press the NEXT button.
"ENTER EXT NO" will be displayed.
3. Press the NEXT button.
"11: CO 1 2 3 4 5 6" will be displayed and "1 2 3 4 5 6" will blink.
4. Dial the CO numbers to be entered.
The desired combination of CO lines will be displayed.
 { To prohibit ringing, press the CLEAR button instead of the CO number.
 "11: CO....." will be displayed.
5. Press the MEMORY button.
The LCD will stop blinking.
6. Repeat steps 3 to 5, to program the assignment of the other extensions.
7. To return to the initial program mode, press the END button.

Conditions

- When you start the programming from step 1, you may dial the desired extension number instead of the NEXT button at step 3.
- The PREV button allows you to go to the previous extension for displaying the CO assignment.

Example: COMPANY XYZ

Company XYZ would like all incoming calls to ring at all extensions during the nighttime:

[10] [NEXT] [*] [1] [2] [3] [4] [5] [6]
[MEMORY] [END]

Programming Table

See page 6-15.

Toll Restriction—Class Assignment

...until the desired extension number appears

...until the desired class of service appears

CLASS 1 default (all 16 extensions)
 CLASS 2
 CLASS 3
 CLASS 4

[11] [NEXT] [NEXT] [SELECT] [MEMORY][END]
 or
 [11] [NEXT] [AB] [SELECT] [MEMORY][END]

AB=[*]: to assign the same on all 16 extensions
 [11]: on extension 11
 ⋮
 [26]: on extension 26

Description

Used to prohibit selected extensions from making long distance calls.

Toll restriction can help eliminate telephone abuse and contribute to controlling telephone costs.

There are four service of classes available for each extension.

	Service Class Selections	
	Allowed	Denied
1	all calls	/
2	toll calls, local calls	international calls
3	local calls, selected area-codes	international calls, any calls other than specific area-code programmed
4	local calls	international calls, toll calls

*For Service Class 3, up to 10 area codes can be selected for use in toll dialing (See "Toll Restriction—Area Code Selection" on page 3-21).

Programming

1. Dial (11).
"TOLL RESTRICTION" will be displayed.
2. Press the NEXT button.
"ENTER EXT NO" will be displayed.
3. Press the NEXT button.
"11: CLASS 1" will be displayed and "1" will blink.
4. Repeat pressing the SELECT button until the desired class is displayed.
5. Press the MEMORY button.
The LCD will stop blinking.
6. Repeat steps 3 to 5, to program the assignment on the other extensions.
7. To return to the initial program mode, press the END button.

Conditions

- When you start the programming from step 1, you may dial the desired extension number instead of the NEXT button at step 3.
- The PREV button allows you to go to the previous extension for displaying the service class assignment.
- In some areas a "1" is needed before dialing the area code for long distance call. If your area does not need to dial a "1", the Programmable Toll Prefix should be set to "WITHOUT 1".
Refer to "Programmable Toll Prefix" page 3-22.

Example:

- To prohibit international calls on extension 13 but allow local and toll calls enter.
[11] [NEXT] [13] [SELECT] [MEMORY]
[END]
or
[11] [NEXT] [NEXT] [NEXT] [NEXT]
[SELECT] [MEMORY][END]
- To prohibit international calls and toll calls on extension 14 but to allow local calls.
[11] [NEXT] [14] [SELECT] [SELECT]
[SELECT] [MEMORY][END]
or
[11] [NEXT] [NEXT] [NEXT] [NEXT]
[NEXT] [SELECT] [SELECT] [SELECT]
[MEMORY] [END]

Programming Table

See page 6-15.

Toll Restriction—Area Code Selection

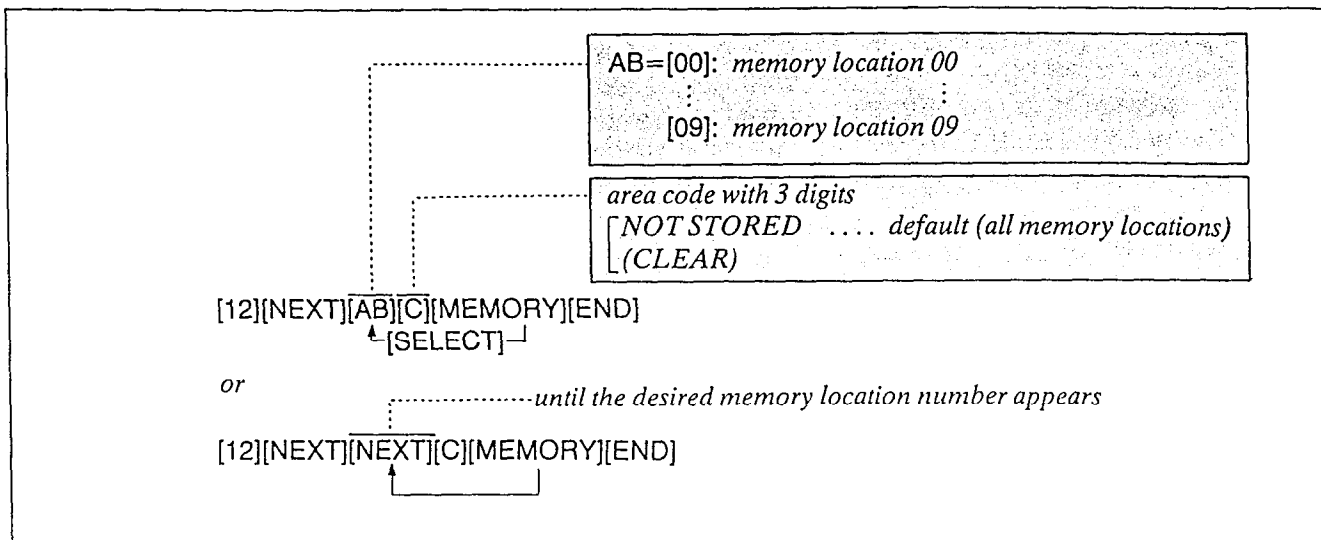

Description

For Service Class 3 (see "Toll Restriction—Class Assignment" on page 3-19.), up to 10 area codes can be selected for use in toll dialing. All area codes except those entered will be denied. All extensions programmed for Service Class Selections 3 shall be assigned to the same area code selection plan.

5. Press the MEMORY button.
 - The memory indicator will be lit.
6. To advance to the next memory location number, press the NEXT button. To return to the previous memory location number, press the PREV button. To go to the desired memory location number, press SELECT button and dial the memory location number.
7. Repeat steps 4 to 6.
8. To return to the initial program mode, press the END button.

Programming

When Service Class 3 is programmed;

1. Dial (12).
"CLASS 3 AREA CODE" will be displayed.
2. Press the NEXT button.
"ENTER CODE NO." will be displayed.
3. Dial (00 through 09) or press the NEXT button.
Example:
When dialing (00) or pressing the NEXT button.
 - The LCD will show "00:NOT STORED" when nothing is stored in memory location number "00".
 - When area code 212 has been stored, "00:212" will be displayed.
4. Dial the area code, with 3 digits.
 - To erase a wrong entry, press the CLEAR button.

Example:

To allow extension 12 to have access to New York City and the entire state of New Jersey, program the following.
New York City has 2 area codes 212, 718 and New Jersey 201, 609.
Enter 212 into the memory location number "00", 718 into "01", 201 into "02" and 609 into "03".

- STEP 1...[11] [NEXT] [NEXT] [SELECT]
[SELECT] [MEMORY][END]
- STEP 2...[12][NEXT][NEXT][212][MEMORY]
[NEXT][718][MEMORY]
[NEXT][201][MEMORY]
[NEXT][609][MEMORY][END]

Programming Table

See page 6-16.

Programmable Toll Prefix

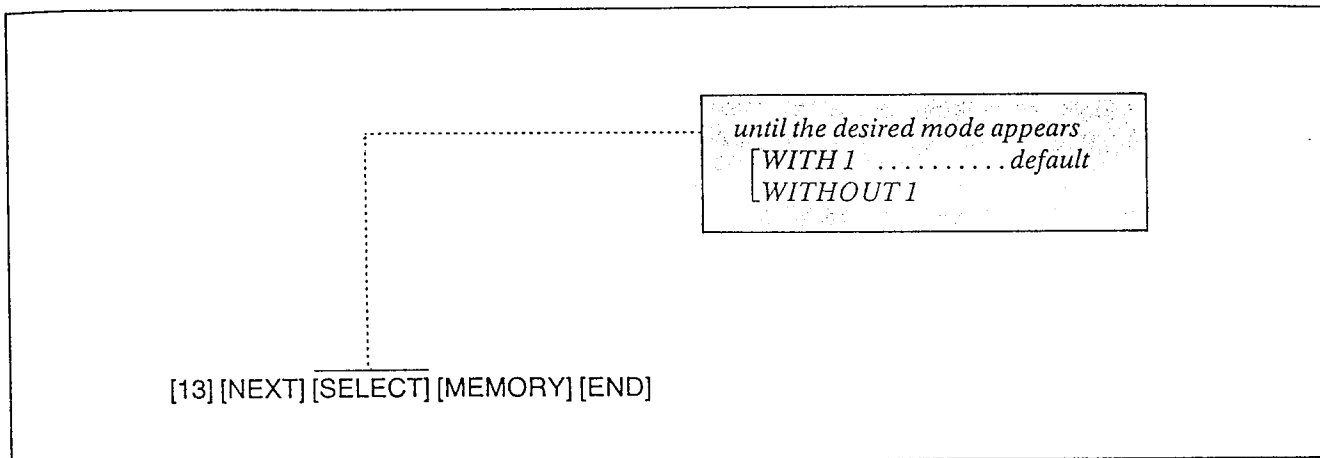

Description

Set to "WITH 1" for Toll Restriction in areas where you are required to dial 1 to toll calls (long distance).

Example:

You are required to insert a "1" before dialing the area code for long distance calls.

1-201-348-7000
└─── area code

Set to "WITHOUT 1" in area where a "1" is not needed.

Programming

1. Dial (13).
"TOLL PREFIX" will be displayed.
2. Press the NEXT button.
"WITH 1" will be displayed and blink.
3. Press the SELECT button to alternate between "WITHOUT 1" and " WITH 1" to select the desired mode.
4. Press the MEMORY button.
The LCD will stop blinking.
5. To return to the initial program mode, press the END button.

Programming Table

See page 6-16.

Programmable Operator Call

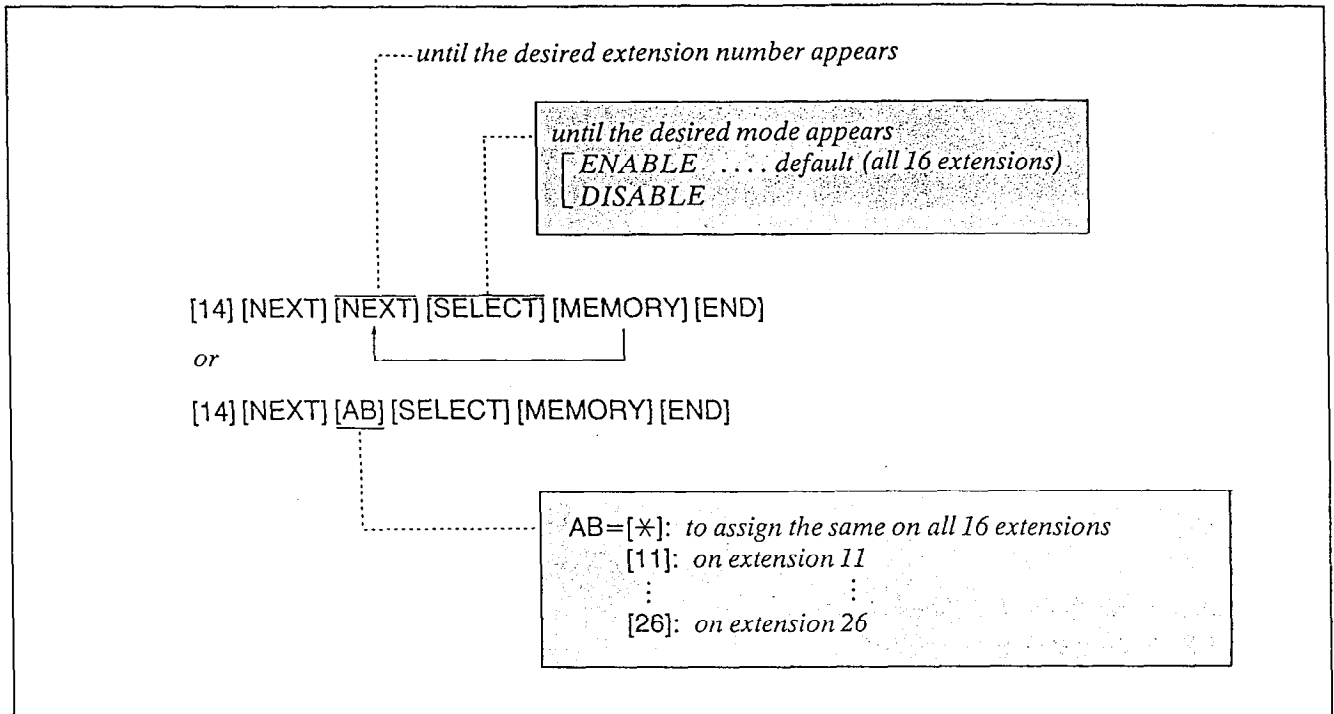

Description

Through programming, you can select of which extensions may dial an Operator Call. To deny all dialing that starts from "0", set to DISABLE.

Programming

1. Dial (14).
"OPERATOR CALL" will be displayed.
2. Press the NEXT button.
"ENTER EXT NO" will be displayed.
3. Press the NEXT button.
"11: ENABLE" will be displayed and "ENABLE" will blink.
4. Press the SELECT button, to alternate between ENABLE and DISABLE to select the desired mode.
5. Press the MEMORY button.
The LCD will stop blinking.
6. Repeat steps 3 to 5, to program the assignment of the other extensions.
7. To return to the initial program mode, press the END button.

Conditions

- When you start the programming from step 1, you may dial the desired extension number instead of the NEXT button at step 3.
- The PREV button allows you to go to the previous extension for displaying the operator call selection.
- Operator call dialing can not be denied if service class 1 of Toll Restriction is used.

Example:

- To prohibit operator call on extension 12

[14] [NEXT] [12] [SELECT] [MEMORY] [END]

Programming Table

See page 6-16.

Programmable Directory Assistance

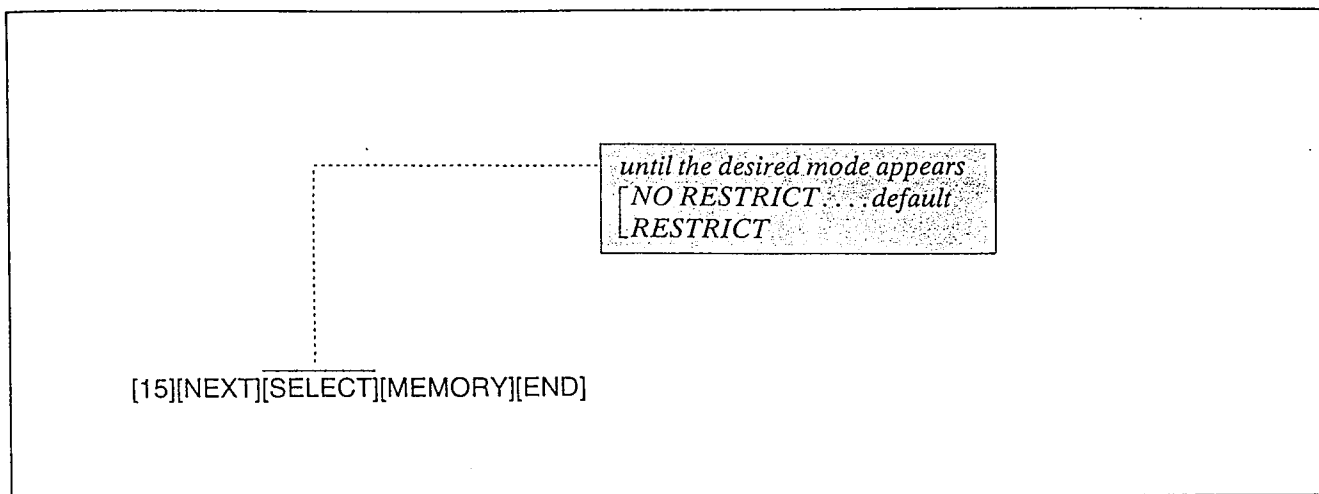

Description

Through programming, you can select which extensions may be dialed Directory Assistance "411". For to deny the directory assistance dialing, set to *RESTRICT*.

Conditions

- Directory assistance dialing can not deny service class 1 and 2 of Toll Restriction.

Programming

1. Dial (15).
"DIRECTORY ASSIST" will be displayed.
2. Press *NEXT* button.
"NO RESTRICT" will be displayed and blink.
3. Press the *SELECT* button to alternate between "NO RESTRICT" and "RESTRICT" to select the desired mode.
4. Press the *MEMORY* button.
The LCD will stop blinking.
5. To return to the initial program mode press the *END* button.

Example:

- To prohibit directory assistance.

[15][NEXT][SELECT][MEMORY][END]

Programming Table

See page 6-16.

Automatic Answering (Automatic/Manual) Selection

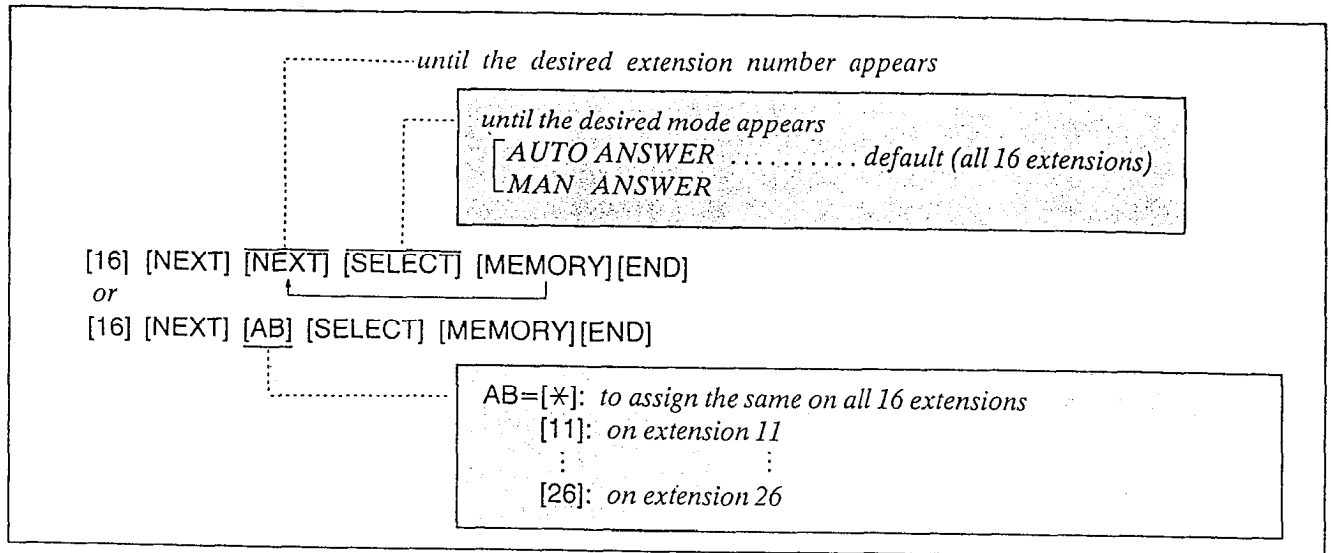

Description

By programming either automatic or manual answering can be set. The auto mode allows the user to answer incoming outside calls simply by lifting the handset, while if programmed to the manual mode, the user must lift the handset and press the flashing CO button.

Programming

1. Dial (16).
"CO ANSWER MODE" will be displayed.
2. Press the NEXT button.
"ENTER EXT NO" will be displayed.
3. Press the NEXT button.
"11: AUTO ANSWER" will be displayed and "AUTO" will blink.
4. Press the SELECT button to alternate between AUTO ANSWER and MAN ANSWER to select the desired mode.
5. Press the MEMORY button.
The LCD will stop blinking.
6. Repeat steps 3 to 5, to program the mode selection of the other extensions.
7. To return to the initial program mode, press the END button.

Conditions

- When you start the programming from step 1, you may dial the desired extension number instead of the NEXT button at step 3.
- The PREV button allows you to go to the previous extension for displaying the automatic answering selection.

Examples:

- AUTO ANSWER mode on the extension 11
[16] [NEXT] [11] [MEMORY][END]
or
[16] [NEXT] [NEXT] [MEMORY][END]
- MANUAL ANSWER mode on the extension 12
[16] [NEXT] [12] [SELECT] [MEMORY]
[END]
or
[16] [NEXT] [NEXT] [NEXT] [SELECT]
[MEMORY][END]

Programming Table

See page 6-16.

Host PBX Access Codes Assignment

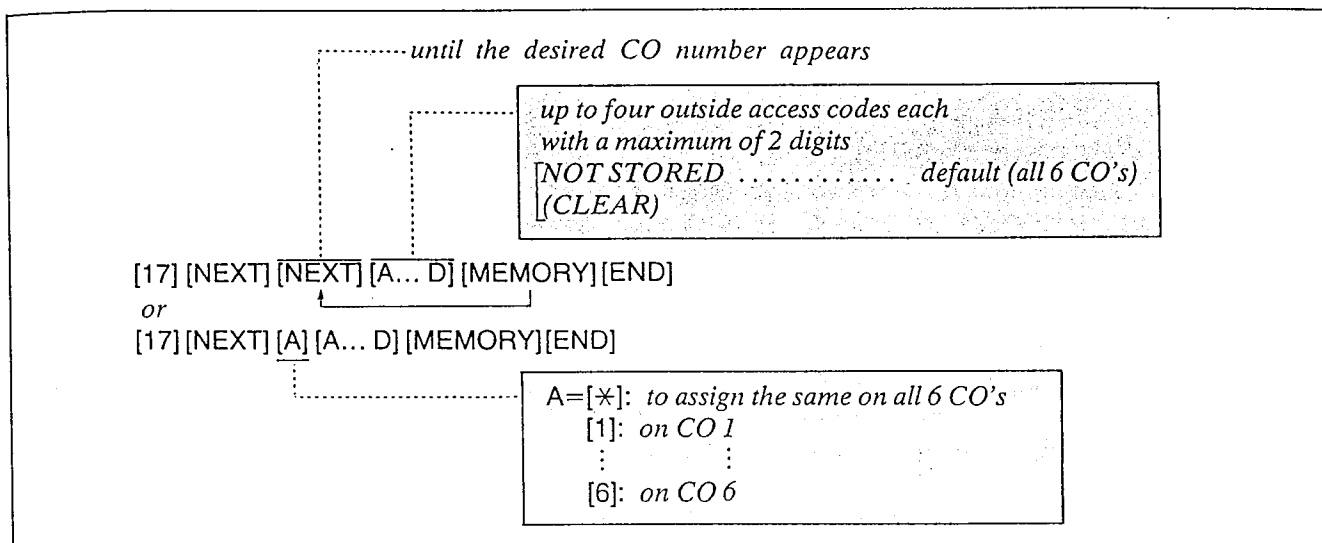

Description

If the system, (KX-T61610) is installed behind a host PBX, the host PBX may require a pause time to access Central Office Lines. This feature enables the host PBX to automatically pause via programming the outward dialing access codes of the host PBX.

6. Repeat steps 3 to 5 to program each of the CO's of the KX-T61610.

7. To return to the initial program mode, press the END button.

Programming

1. Dial (17).
"HOST PBX ACCESS" will be displayed.
2. Press the NEXT button.
"ENTER CO NO" will be displayed.
3. Press the NEXT button.
 - The LCD will show "CO1: NOT STORED" when nothing is stored in CO1. When the outside access codes 81, 82 has been stored, "CO1:81, 82" will be displayed.
4. Enter up to four outward access codes each with a maximum of 2 digits, punctuating each code with the button.
 - To erase a wrong entry, press the CLEAR button.
5. Press the MEMORY button.

Conditions

- When you start the programming from step 1, you may dial the desired CO number instead of the NEXT button at step 3.
- The PREV button allows you to go to the previous CO for displaying the host PBX access codes assignment.

Example:

- Access codes 81, 82, 83, 9 on CO1=
[17] [NEXT] [1] [81] [,] [82] [,] [83] [,] [9]
[MEMORY] [END]
or
[17] [NEXT] [NEXT] [81] [,] [82] [,] [83] [,] [9]
[MEMORY] [END]

Programming Table

See page 6-16.

PROGRAMMING

Preferred CO Line Assignment

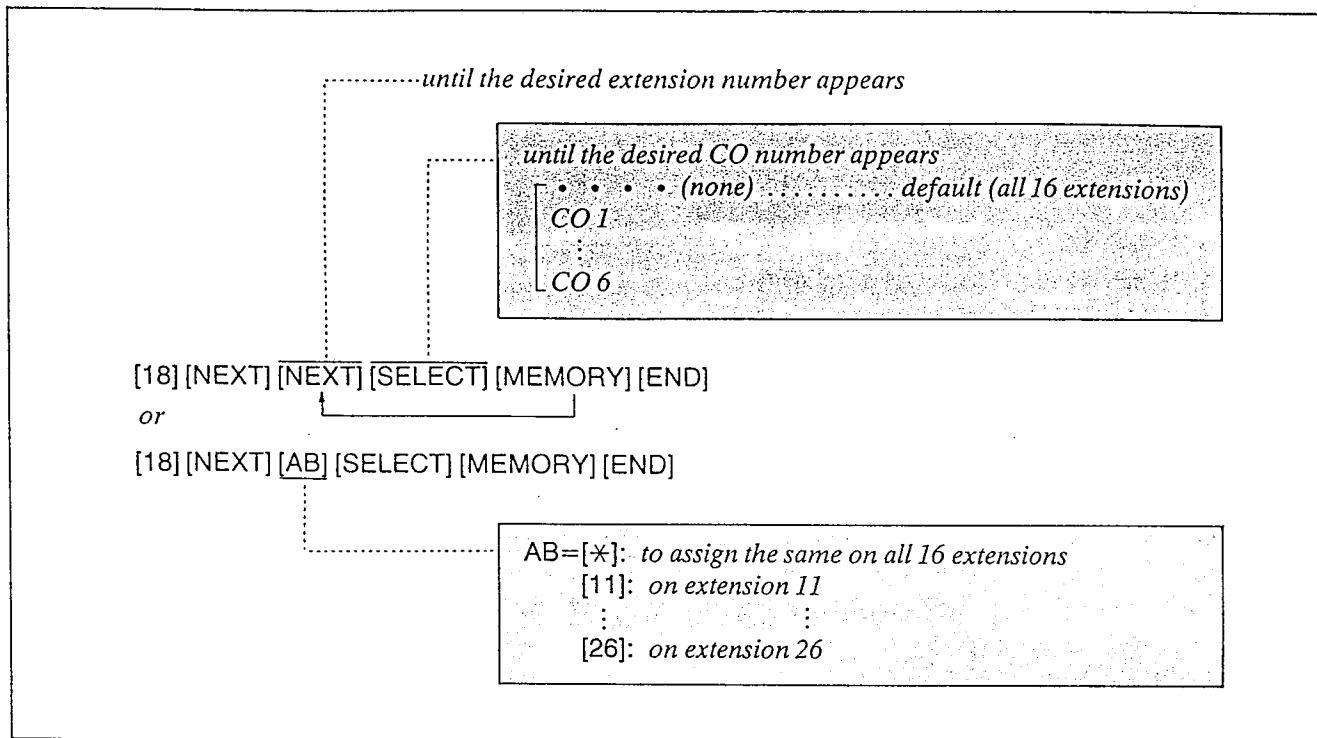

Description

When any incoming calls from the Central Office are received at the same time, you can receive the call on the preferred CO line first.

Programming

1. Dial (18).
"PREFERRED CO" will be displayed.
2. Press the NEXT button.
"ENTER EXT NO" will be displayed.
3. Press the NEXT button.
"11:" will be displayed and
". . . ." will blink.
4. Repeat pressing the SELECT button until the desired CO number is displayed.
5. Press the MEMORY button.
The LCD will stop blinking.
6. Repeat steps 3 to 5, to program the assignment of the other extensions.
7. To return to the initial program mode, press the END button.

Conditions

- When you start the programming from step 1, you may dial the desired extension number instead of the NEXT button at step 3.
- The PREV button allows you to go to the previous extension for displaying the preferred CO line assignment.

Programming Table

See page 6-17.

Programmable Call Waiting

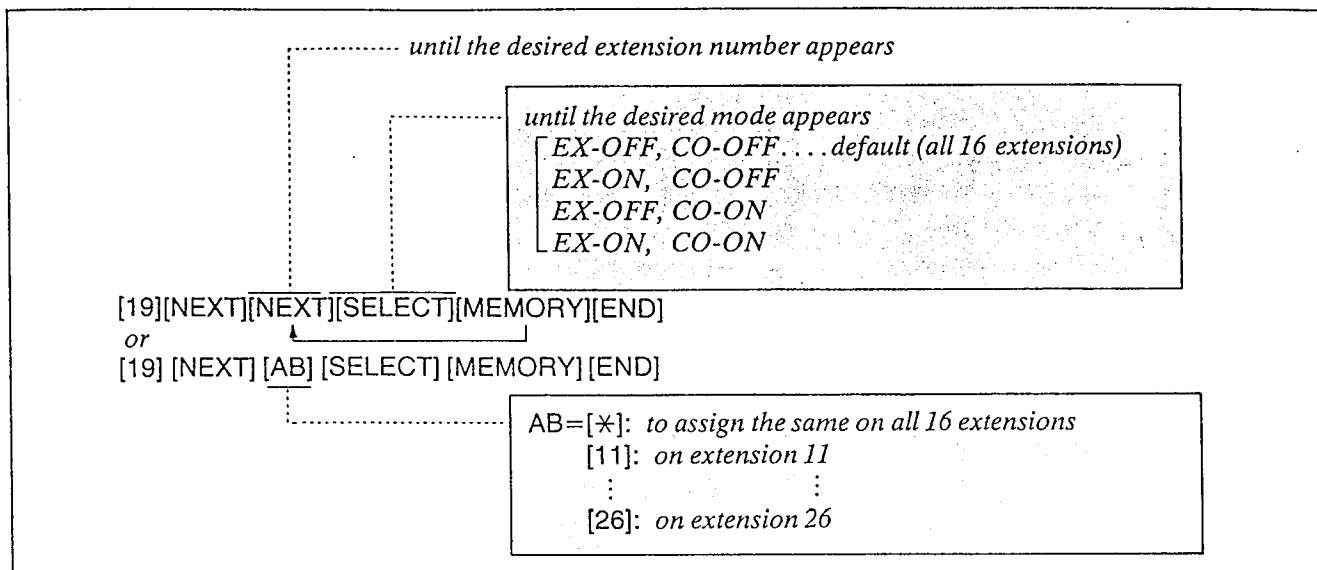

Description

During a conversation, a call waiting tone will be heard when a third party on an outside line or intercom calls you.

Call waiting tone can be removed or added at customer's request.

Set to "ON" for call waiting.

Programming

1. Dial (19).
"CALL WAITING" will be displayed.
2. Press the NEXT button.
"ENTER EXT NO" will be displayed.
3. Press the NEXT button.
"11: EX-OFF, CO-OFF" will be displayed and "EX-OFF, CO-OFF" will blink.
4. Repeat pressing the SELECT button until the desired mode is displayed.

5. Press the MEMORY button.
The LCD will stop blinking.

6. Repeat steps 3 to 5, to program the assignment of the other extensions.

7. To return to the initial program mode, press the END button.

Conditions

- When you start the programming from step 1, you may dial the desired extension number instead of the NEXT button at step 3.
- The PREV button allows you to go to the previous extension for displaying the call waiting selection.

Programming Table

See page 6-17.

Delayed Ringing Assignment

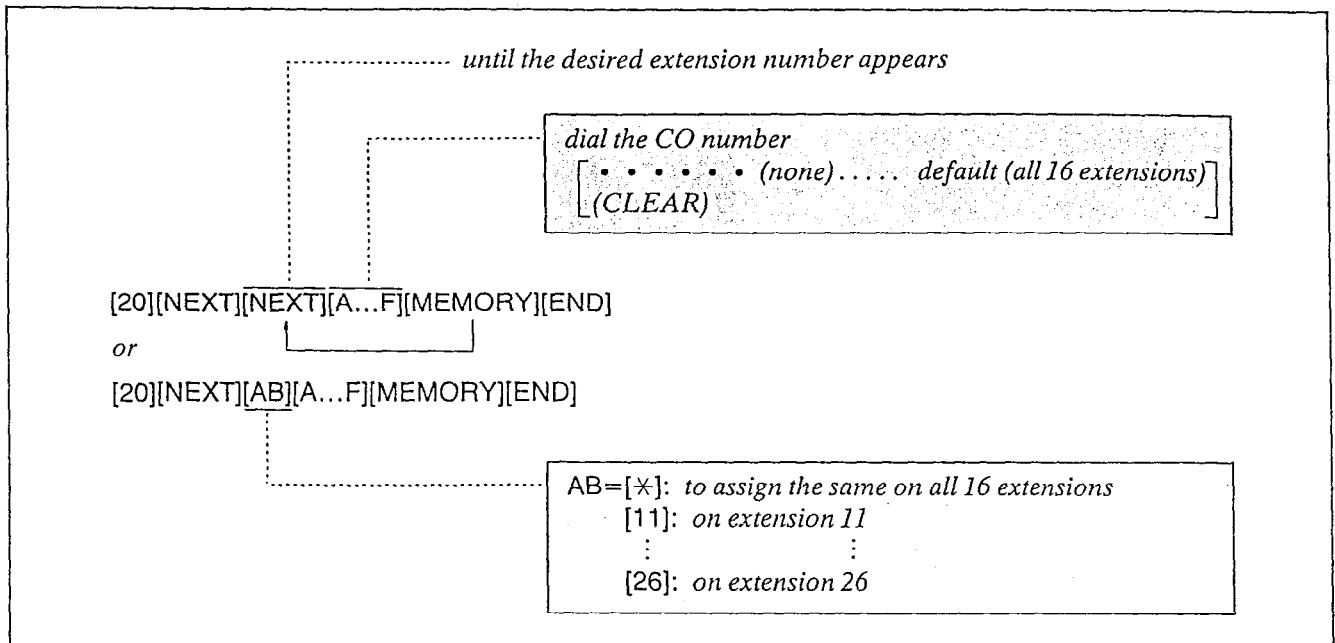

Description

The ringing start time can be delayed on a designated extension(s) when an incoming call is received from the CO.

The CO line(s) that you want to delay the ring start time can be selected through the programming. "Delayed Ringing Count Selection" page 3-30 should be set.

Programming

1. Dial (20).
"DELAY RING CO" will be displayed.
2. Press the NEXT button.
"ENTER EXT NO" will be displayed.
3. Press the NEXT button.
"11: CO" will be displayed and "." will blink.
4. Dial the CO numbers to be entered.
The desired combination of CO will be displayed.
[To prohibit dialing, press the CLEAR button instead of CO number.
"11: CO" will be displayed.
5. Press the MEMORY button.
The LCD will stop blinking.

6. Repeat 3 to 5, to program the assignment of the other extensions.

7. To return to the initial program mode, press the END button.

Conditions

- When you start the programming from step 1, you may dial the desired extension number instead of the NEXT button at step 3.
- The PREV button allows you to go to the previous extension for displaying the delayed ringing assignment.

Programming Table

See page 6-17.

Delayed Ringing Count Selection

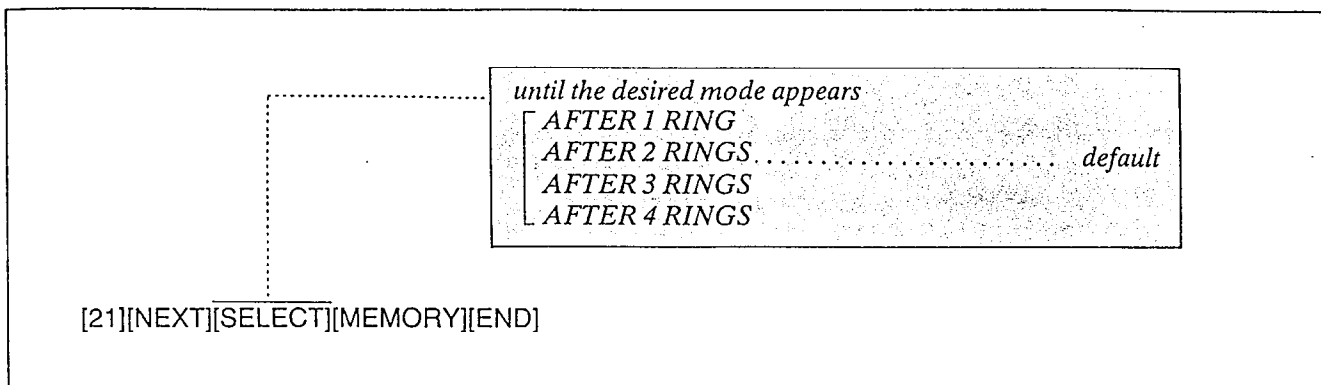

Description

After you select the CO lines that you want to delay the ring start time, select the desired delay ring count. Refer to "Delayed Ringing Assignment" page 3-29.

Programming

1. Dial (21).
"DELAY RING COUNT" will be displayed.
2. Press the NEXT button.
"AFTER 2 RINGS" will be displayed and will blink.
3. Repeat pressing the SELECT button until the desired mode is displayed.
4. Press the MEMORY button.
The LCD will stop blinking.
5. To return to the initial program mode, press the END button.

Programming Table

See page 6-17.

Intercom Alerting Mode

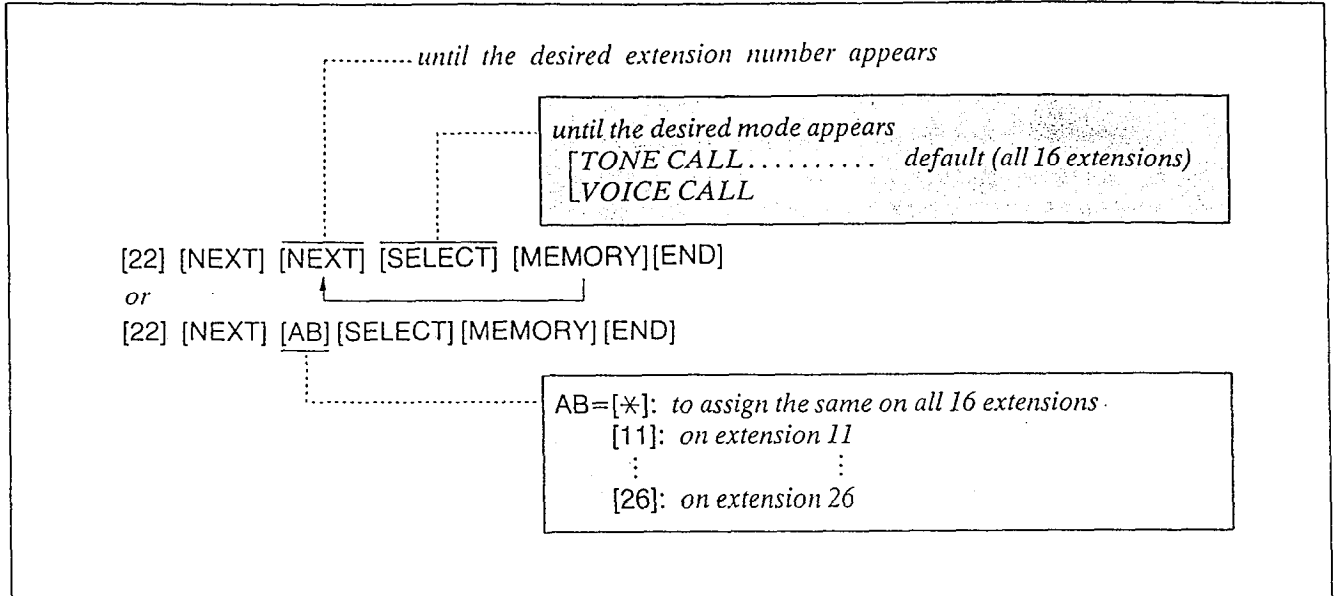

Description

The intercom alerting mode (tone alerting/voice alerting) at a receiving extension can be selected through programming.

TONE.. Tone alerting (ringing) sound at the receiving extension.

VOICE... Voice alerting instead of Tone alerting is heard through the speaker on the receiving extension.

Conditions

- When you start the programming from step 1, you may dial the desired extension number instead of the NEXT button at step 3.
- The PREV button allows you to go to the previous extension for displaying the alerting mode.

Example:

- VOICE CALL on the extension 13
[22] [NEXT] [13] [SELECT] [MEMORY]
[END]

Programming

1. Dial (22).
"INTCOM CALL MODE" will be displayed.
2. Press the NEXT button.
"ENTER EXT NO" will be displayed.
3. Press the NEXT button.
"11: TONE CALL" will be displayed and "TONE" will blink.
4. Press the SELECT button to alternate between TONE CALL and VOICE CALL to select the desired mode.
5. Press the MEMORY button.
The LCD will stop blinking.
6. Repeat steps 3 to 5 to program the call mode of the other extensions.
7. To return to the initial program mode, press the END button.

Programming Table

See page 6-17.

Programmable Doorphone

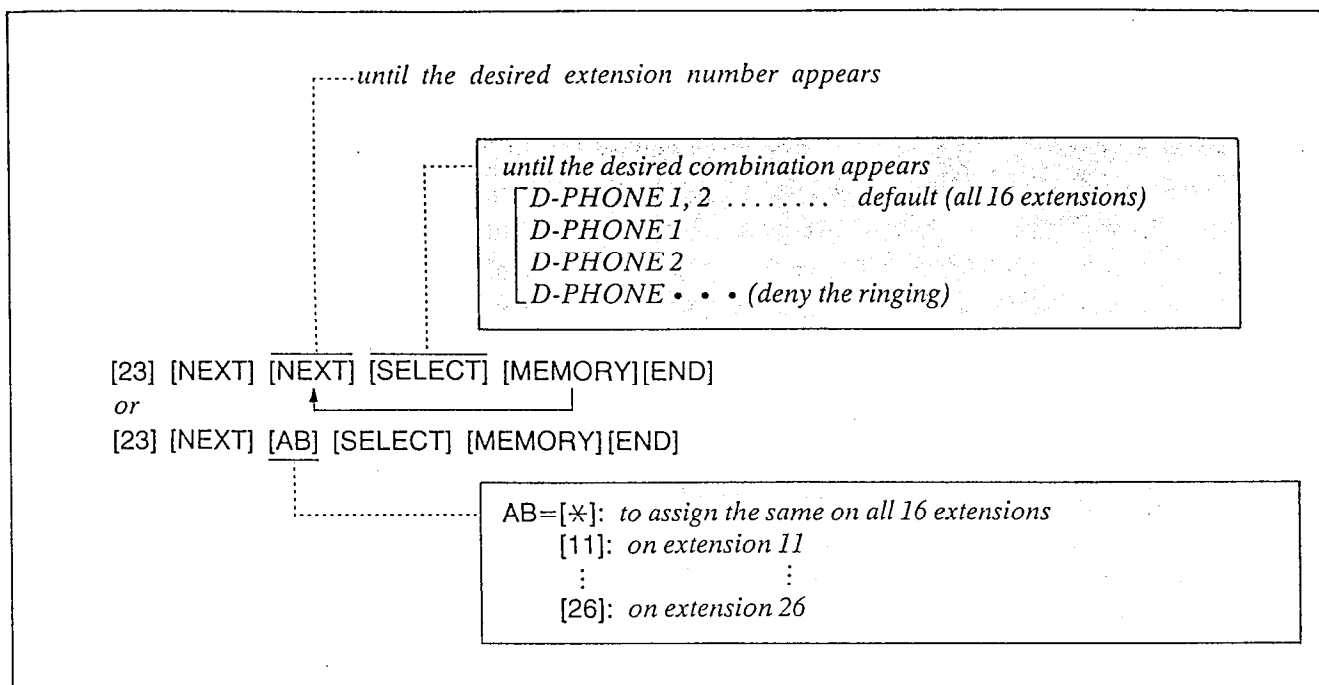

Description

Allows each extension to be programmed for receiving calls from up to 2 doorphones. (Doorphone is an option.)

Programming

1. Dial (23).
"DOOR PHONE RCV" will be displayed.
2. Press the NEXT button.
"ENTER EXT NO" will be displayed.
3. Press the NEXT button.
"11: D-PHONE 1, 2" will be displayed and "1, 2" will blink.
4. Repeat pressing the SELECT button until the desired combination of doorphones (which are to be connected to that extension) is displayed.
5. Press the MEMORY button.
The LCD will stop blinking.
6. Repeat steps 3 to 5, to program the combination of the other extensions.
7. To return to the initial program mode, press the END button.

Conditions

- When you start the programming from step 1, you may dial the desired extension number instead of the NEXT button at step 3.
- The PREV button allows you to go to the previous extension for displaying the door-phone assignment.

Example:

- To allow extension 12 to receive from D-PHONE 2
 [23] [NEXT] [12] [SELECT] [SELECT]
 [MEMORY] [END]

Programming Table

See page 6-17.

Dial Call Pickup Group Assignment

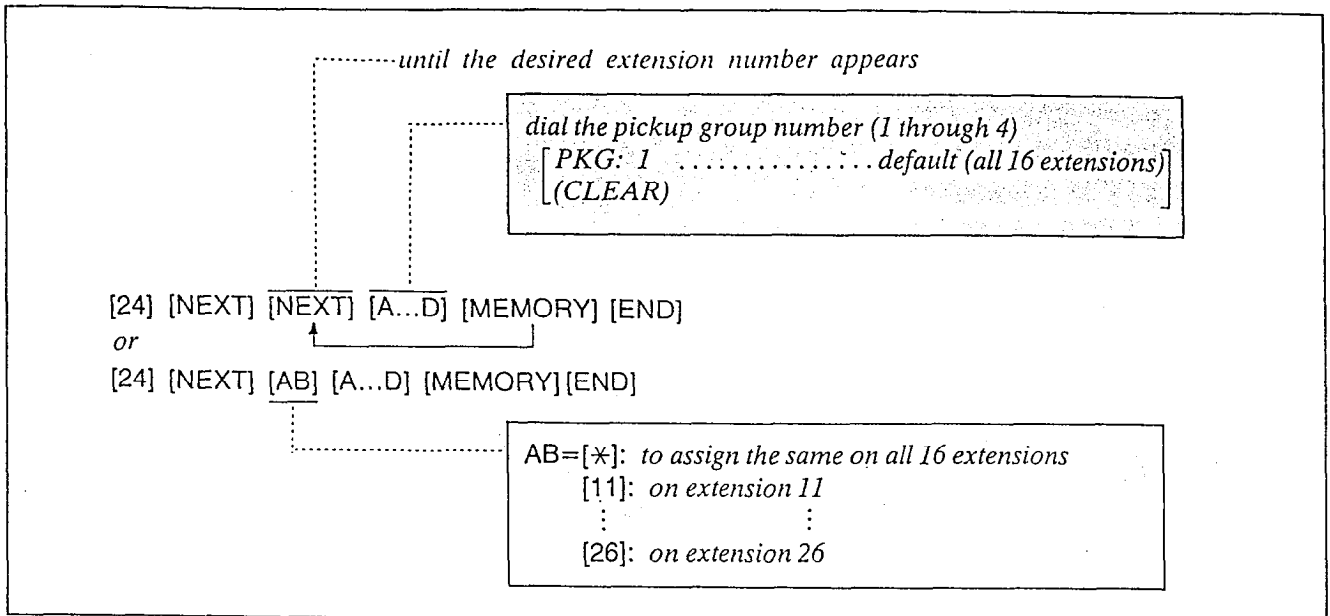

Description

Permits an extension user to answer other ringing telephones, provided that they are in the same pickup group.

6. Repeat steps 3 to 5, to program the assignment of the other extensions.

7. To return to the initial program mode, press the END button.

Programming

1. Dial (24).
"PICKUP GROUP" will be displayed.
2. Press the NEXT button.
"ENTER EXT NO" will be displayed.
3. Press the NEXT button.
"11: PKG: 1" will be displayed and "1" will blink. This means that extension 11 belongs to pickup group 1.
4. Dial the pickup group number (1 through 4) to be entered.
The desired combination of pickup group will be displayed.
[To be out of any groups, press the CLEAR button instead of group number.
5. Press the MEMORY button.
The LCD will stop blinking.

Conditions

- Each extension may belong to more than one pickup group, up to four, or may not belong to a group.
- When you start the programming from step 1, you may dial the desired extension number instead of the NEXT button at step 3.
- The PREV button allows you to go to the previous extension for displaying the pickup group assignment.

Examples:

- extension 14...Pickup Group 2
[24][NEXT][14][2][MEMORY][END]
- extension 15...Pickup Group 3
[24][NEXT][15][3][MEMORY][END]

Programming Table

See page 6-18.

Account Code Input Mode

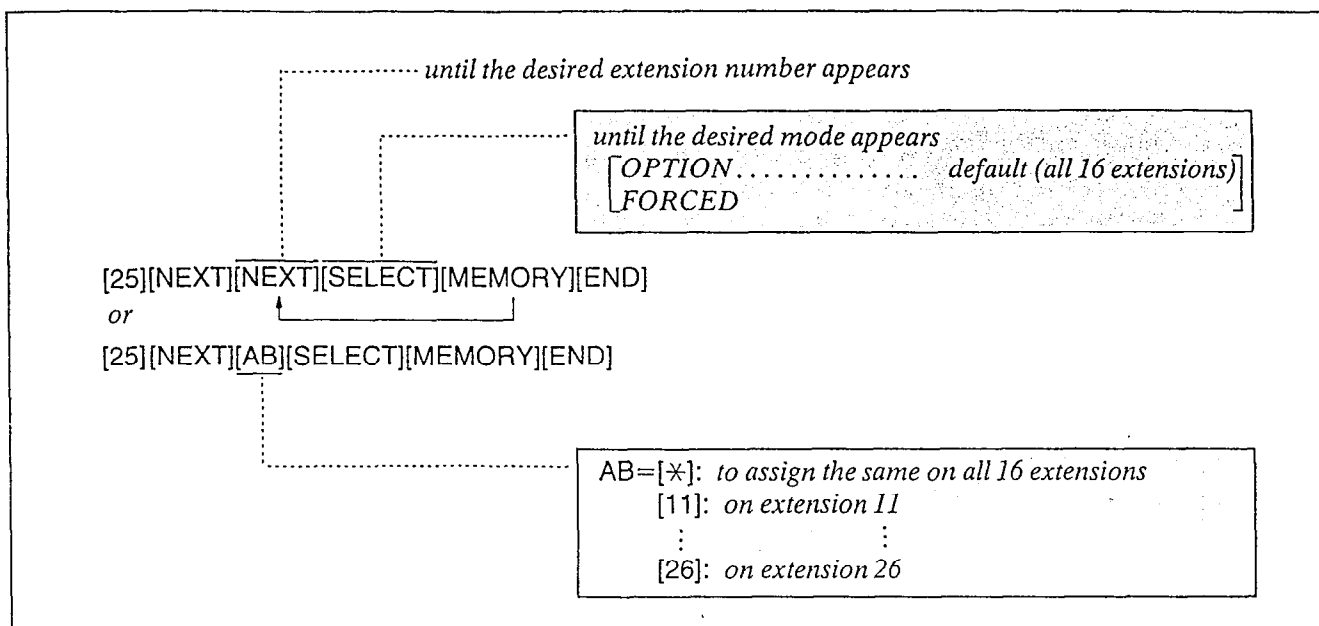

Description

This feature gives each message of the SMDR an account code of the called or calling party. This feature has two modes "FORCED" and "OPTION". In the "FORCED" mode, the account code must be entered every time extension user dials.

In the "OPTION" mode, the account code may be entered when a record is needed. Refer to "Account Code" page 4-25.

5. Press the MEMORY button.
The LCD will stop blinking.
6. Repeat steps 3 to 5, to program the account code of the other extensions.
7. To return to the initial program mode, press the END button.

Programming

1. Dial (25).
"ACCOUNT CODE MOD" will be displayed.
2. Press the NEXT button.
"ENTER EXT NO" will be displayed.
3. Press the NEXT button.
"11: OPTION" will be displayed and the "OPTION" will blink.
4. Press the SELECT button to alternate between OPTION and FORCED to select the desired mode.

Conditions

- When you start the programming from step 1, you may dial the desired extension number instead of the NEXT button at step 3.
- The PREV button allows you to go to the previous extension for displaying the account code input mode.

Programming Table

See page 6-18.

Duration Time Count Start Mode

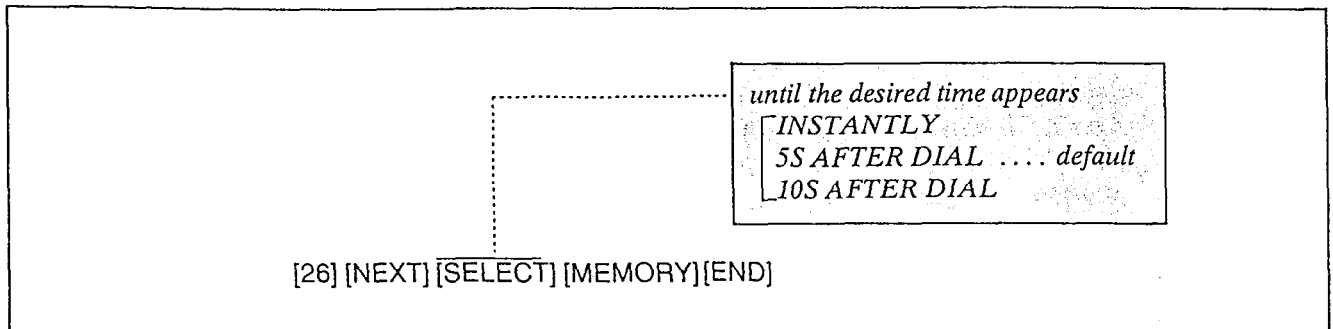

Description

The duration time of the conversation is displayed.

Program the start time of the timer.

- Instantly after the CO line is captured.
- 5 seconds after the dialing
- 10 seconds after the dialing

Example:

10 seconds after the dialing

= [26] [NEXT] [SELECT] [MEMORY] [END]

Programming Table

See page 6-18.

Programming

1. Dial (26).
 - "DURAT-TIME COUNT" will be displayed.
2. Press the NEXT button.
 - "5S AFTER DIAL" will be displayed and blink.
3. Repeat pressing the SELECT button until the desired time (INSTANTLY, 5S AFTER DIAL, 10S AFTER DIAL) is displayed.
4. Press the MEMORY button.

The LCD will stop blinking.
5. To return to the initial program mode, press the END button.

Station Message Detail Recording (SMDR) Communication Parameters

Description

SMDR is a cost saving feature that records on a printer a record of all incoming and outgoing calls. The following information is provided on the printout.

The SMDR will print out the security code of the long distance service. (MCI, SPRINT etc.)

NOTE:

When plugging a printer into the KX-T61610 make sure that the printer power is off.

Select the SMDR Communication Parameters, System Data Dump and SMDR Incoming/Outgoing Selection for proper operation.

Example of print

Date	Time	Ext.	CO	Dial Number	Duration	Code
4/20/87	8:00 AM	26	6	1-201-234-5678	00:00'30"	0123
_____ _____. year _____. day _____. month			_____ _____. CO _____. number _____. extension	_____ _____. called _____. party	_____ _____. second _____. minute _____. hour	_____ _____. account code

- When you have an incoming call, the printer will print <<incoming>>.
- When "=" appears in the Dial Number, the previous number of "=" indicates the line access number of the Host PBX.
- When "*" appears in front of the Time, this means the time that the call is transferred.

SMDR Printer Format Selection

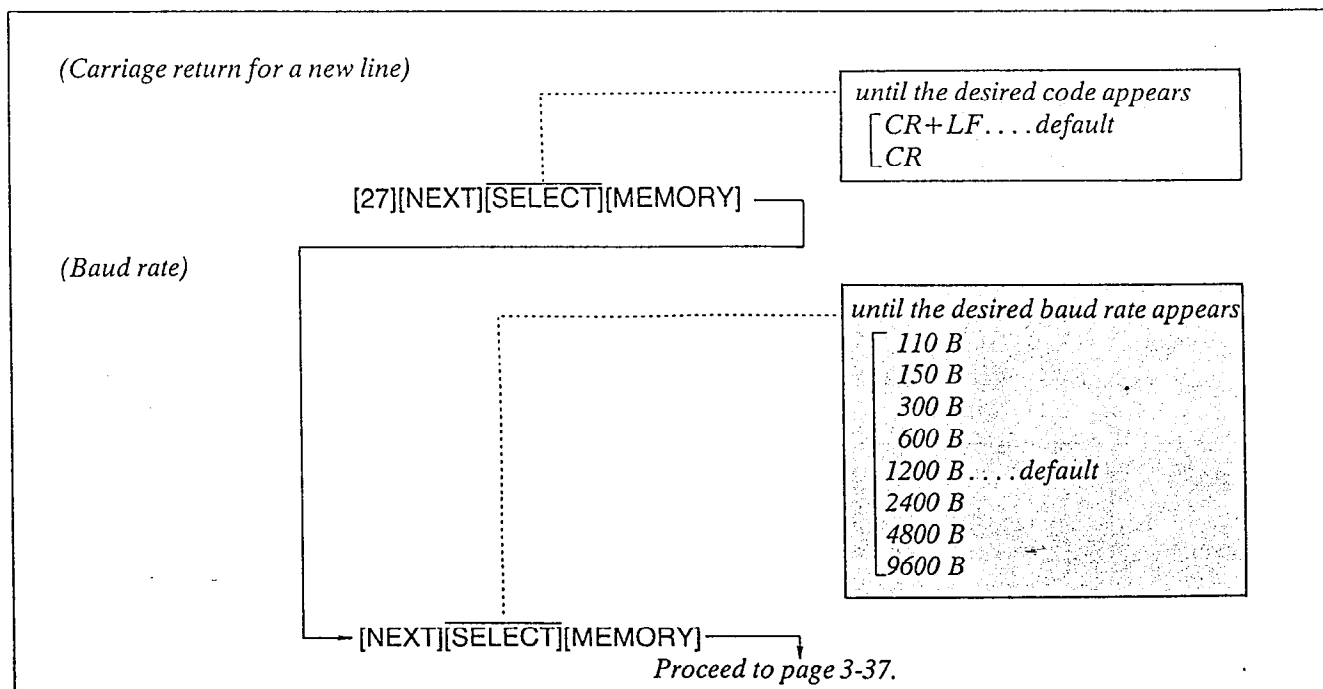

PROGRAMMING

(Word length)

Continued from page 3-36.

until the desired length appears
[7 BITS . . . default
[8 BITS

[NEXT][SELECT][MEMORY]

(Parity)

until the desired mode appears
[NONE
[MARK . . . default
[SPACE
[EVEN
[ODD

[NEXT][SELECT][MEMORY]

(Stop bit length)

until the desired mode appears
[1 BIT . . . default
[2 BITS

[NEXT][SELECT][MEMORY]

(Page length)

AB=[4] (lines)
⋮
[66] . . . default
⋮
[99]

[NEXT][A B][MEMORY]

(Skip perforation)

AB=[0] (line) . . . default
⋮
[95]

[NEXT][A B][MEMORY][END]

Carriage return for a new line

A new line code indicates what type of code is needed for the print head on a printer to move the first character position on the next line.

CR+LF
 when "CR+LF" is required from a printer.

CR
 when "CR" is required from a printer.

CR=Carriage Return
LF=Line Feed.

Baud rate

A baud rate code indicates the data transmission speed from the system to a printer.

110 B (when 110 baud is required.)
 150 B (when 150 baud is required.)
 300 B (when 300 baud is required.)
 600 B (when 600 baud is required.)
 1200 B (when 1200 baud is required.)
 2400 B (when 2400 baud is required.)
 4800 B (when 4800 baud is required.)
 9600 B (when 9600 baud is required.)

The default value is the same as that of the Panasonic data terminal, KX-D4910D, KX-D4911, KX-D4920 etc, except baud rate.

Parity

A parity code indicates what type of parity is used to detect an error in a string of bits composing a character.

NONE: when an error checking function is not required from a printer.

MARK: when a Mark is required from a printer.

SPACE: when a Space is required from a printer.

EVEN: when an Even is required from a printer.

ODD: when an Odd is required from a printer.

Word length

A word length code indicates how many bits compose a character.

7 BITS (when 7 bits are required.)
 8 BITS (when 8 bits are required.)

Stop bit length

A stop bit length code indicates the end of a bit string which composes a character.

1 BIT:
 when one bit is required for end detection.

2 BITS:
 when two bits are required for end detection.

Page length

The page length may be selected to position a title and data on each page.
 A page length code indicates the number of lines per page.
 A title will be printed on the first 3 lines of each page.

4 lines per page
 :
 99 lines per page

STANDARD CONTINUOUS PAPER (11 inches)

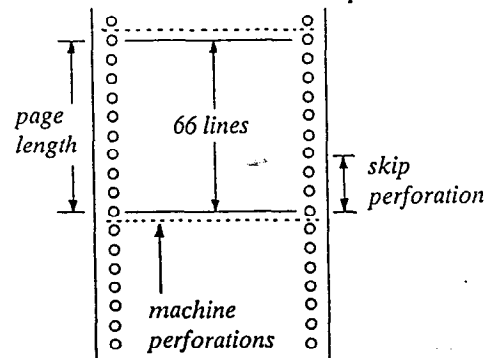

To print data, page length must be longer than skip perforation by 4 or more lines.

PROGRAMMING

Skip perforation

The skip perforation code indicates the number of lines to be skipped. When the print head reaches the line designated, the print head moves to the top position of the next page.

0 (print head does not skip.)
1 (print head skips the last line.)
2 (print head skips the last 2 lines.)
⋮
95 (print head skips the last 95 lines.)

Programming

1. Dial (27).
"SMDR PARAMETERS" will be displayed.
2. Press the NEXT button.
"NL-CODE: CR+LF" will be displayed and "CR+LF" will blink.
3. Press the SELECT button to alternate between CR+LF and CR to select the desired mode.
4. Press the MEMORY button.
The LCD will stop blinking.
5. Press the NEXT button.
"BAUD RATE: 1200B" will be displayed and the "1200B" will blink.
6. Repeat pressing the SELECT button until the desired baud rate is displayed.
7. Press the MEMORY button.
The LCD will stop blinking.
8. Press the NEXT button.
"WORD LENGT: 7BITS" will be displayed and the "7BITS" will blink.
9. Press the SELECT button to alternate between 7BITS and 8BITS to select the desired mode.
10. Press the MEMORY button.
The LCD will stop blinking.
11. Press the NEXT button.
"PARITY: MARK" will be displayed and the "MARK" will blink.

12. Repeat pressing the SELECT button until the desired parity code is displayed.
13. Press the MEMORY button.
The LCD will stop blinking.
14. Press the NEXT button.
"STOP BIT: 1BIT" will be displayed and the "1BIT" will blink.
15. Press the SELECT button to alternate between 1BIT and 2BITS to select the desired mode.
16. Press the MEMORY button.
The LCD will stop blinking.
17. Press the NEXT button.
"PAGE LENGTH: 66" will be displayed and the "66" will blink.
18. Dial (4 through 99) for the page length entry.
19. Press the MEMORY button.
The LCD will stop blinking.
20. Press the NEXT button.
"SKIP PERF: 0" will be displayed and the "0" will blink.
21. Dial (0 through 95) for the skip perforation code entry.
22. Press the MEMORY button.
The LCD will stop blinking.
23. To return to the initial program mode, press the END button.

Programming Table

See page 6-18.

Conditions

- To return to the previous mode, press the PREV button instead of the NEXT button.

Conditions

The following combinations are disallowed.

parity	word length	stop bit length
mark	8	2
space	8	1
space	8	2
none	7	1
even	8	2
odd	8	2

If any of the above disallowed combinations are selected, "INPUT ERROR" will be displayed. Press the NEXT button and then repeat the procedure of programming.

The pin configuration of EIA (RS-232C) connector is as follows.

Pin Number	Signal Name		Circuit Type ^A	
			EIA	CCITT
1	FG	Frame Ground	AA	101
2	TXD	Transmitted Data	BA	103
3	RXD	Received Data	BB	104
4	RTS	Request To Send	CA	105
5	CTS	Clear To Send	CB	106
6	DSR	Data Set Ready	CC	107
7	SG	Signal Ground	AB	102
8	DCD	Data Carrier Detect	CF	109
20	DTR	Data Terminal Ready	CD	108.2

EIA SIGNALS:

Frame Ground (FG);

Connects to the unit frame and the earth ground conductor of the AC power cord.

Transmitted Data (TXD); (output)

Conveys signals from the unit to the printer. A "MARK" condition is held unless data or BREAK signals are being transmitted.

Received Data (RXD); (input)

Conveys signals from the printer.

Request To Send (RTS); (output)

This lead is held ON whenever DSR is ON.

Clear To Send (CTS); (input)

An ON condition of circuit CTS indicates that the printer is ready to receive data from the unit.

The unit does not attempt to transfer data or receive data when circuit CTS is OFF.

Data Set Ready (DSR); (input)

An ON condition of circuit DSR indicates the printer is ready.

Circuit DSR ON does not indicate that communication has been established with the printer.

Signal Ground (SG);

Connects to the DC ground of the unit for all interface signal.

Data Terminal Ready (DTR) (output)

This signal line is turned ON by the unit to indicate that it is ON LINE.

Circuit DTR ON does not indicate that communication has been established with the printer.

It is switched OFF when the unit is OFF LINE.

Data Carrier Detect (DCD) (input)

The ON condition is an indication to data terminal (DTE) that the carrier signal is being received.

System Data Dump

• *STOP OUTPUT*

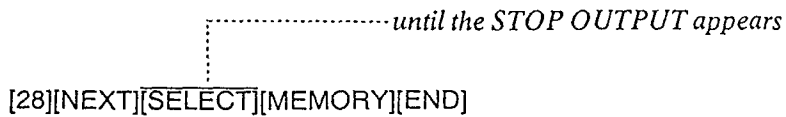

- *SYSTEM PARA*
- *SPEED DIAL*
- *ALL PARA (Master)*

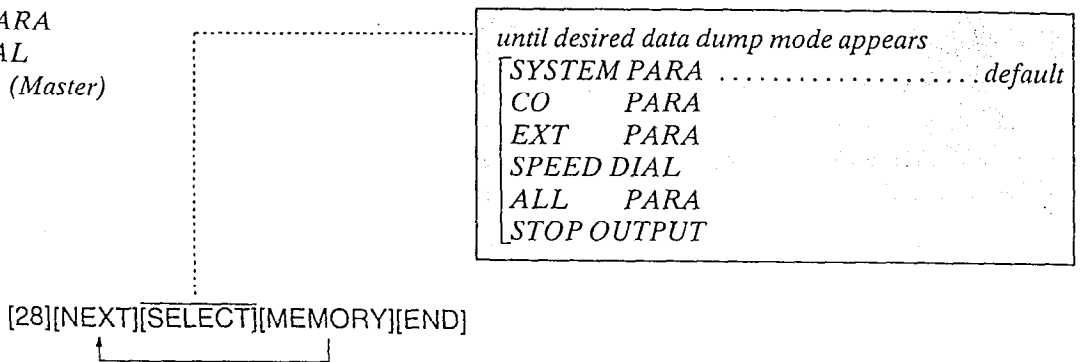

• *CO PARA (Outside)*

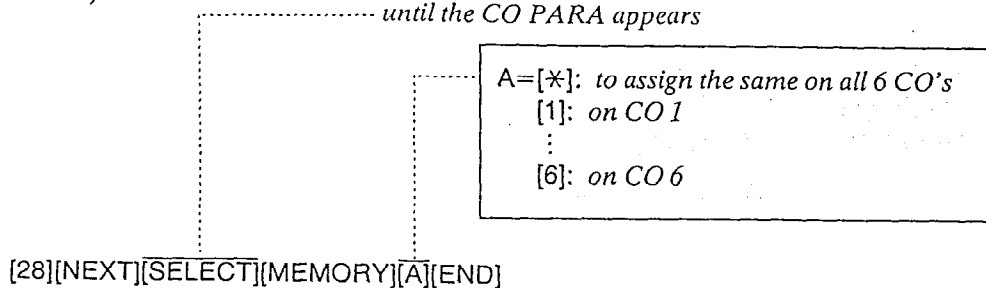

• *EXT PARA*

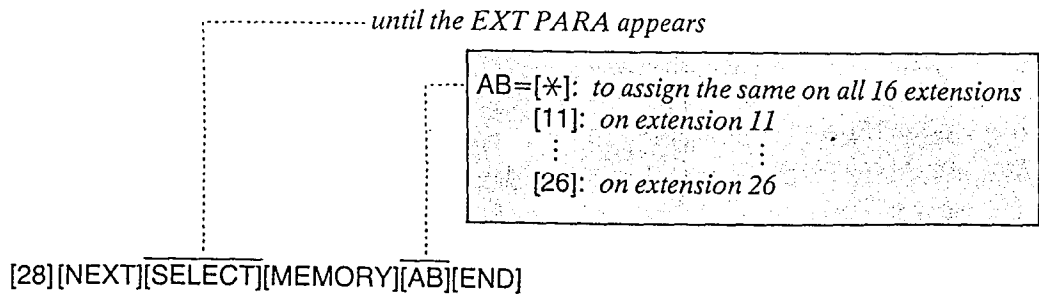

Description

Five separate printouts are available.
They are (1) System parameters (2) CO parameters (3) Extension parameters (4) Speed dial (5) All parameters (master)

System parameters

Day/Night
Area codes of class-3
Toll prefix
Directory Assistance
Delay Ring count
Duration time count
SMDR parameters
Duration log
Auto hold alarm time
Hold recall time
Transfer recall time
Ext-paging access tone
Secret speed dialing
DTMF receiver selection
Door phone receive extension
Pickup group assignments
DSS operation mode
DSS console set

CO parameters

Connection
Dial mode
Host PBX access code
Hookswitch flash time
Disconnect time
CPC Detection

Extension parameters

- (When the KX-T61630, KX-T61620, KX-T61650, KX-T30830, KX-T30820 or KX-T30850 is connected at extension.)
Telephone type
Outgoing CO Day/Night
Incoming CO Day/Night
Toll restriction
Operator Call
CO answer mode
Incoming preferred CO
Call waiting

Delayed Ringing CO
Intercom call mode
Account code input mode
Automatic CO hunting
Do not disturb
Call forwarding
Data line security
Dial call pickup deny
Feature button assignments
CO button assignments
DSS button assignments (KX-T30830 only)
<<DSS Console Items>>
Feature button assignments
DSS button assignments

- (When the standard telephone or DSS Console is connected at extension)

Telephone type
DSS console connection
Outgoing CO Day/Night
Incoming CO Day/Night
Toll restriction
Operator call
Incoming preferred CO
Call waiting
Delayed ringing CO
Account code input mode
Pickup dial
Do not disturb
Call forwarding
Data line security
Dial call pickup deny

Speed dial

Speed access codes (00 through 99) in which phone numbers are stored may be printed.

All parameters (master)

System parameters
CO parameters
Extension parameters
Speed dial

Operation

To stop the printout;

1. Dial (28).
2. Press the NEXT button.
3. Repeat pressing the SELECT button until STOP OUTPUT is displayed.
4. Press the MEMORY button.
"STOP PRINTING !!" will be displayed.

When the System Parameters, Speed dial or All Parameters is printed.

1. Dial (28).
"SYSTEM DATA OUT" will be displayed.
2. Press the NEXT button.
"MENU: SYSTEM PARA" will be displayed and "SYSTEM PARA" will blink.
3. Repeat pressing the SELECT button until the desired data dump mode is displayed.
4. Press the MEMORY button.
The LCD will stop blinking.
5. Repeat step 2 to 4, to print the other data dumps.

When the CO Parameter is printed;

1. Dial (28).
2. Press the NEXT button.
3. Repeat pressing the SELECT button until the "CO PARA" is displayed.
4. Press the MEMORY button.
"ENTER CO NO" is displayed.
5. Dial the CO number.
SMDR printer will print out.
"PRINTING NOW" will be displayed.
6. To print the other CO parameter, press the SELECT button and then dial the CO number.

When the Extension Parameter is printed;

1. Dial (28).
2. Press the NEXT button.
3. Repeat pressing the SELECT button until the "EXT PARA" is displayed.
4. Press the MEMORY button.
"ENTER EXT NO" is displayed.
5. Dial the extension number.
SMDR printer will print out.
"PRINTING NOW" will be displayed.
6. To print the other extension parameter, press the SELECT button and then dial the extension number.

After completing printing, to return to the initial mode;

1. Press the END button.

Programming Table

See page 6-19.

Station Message Detail Recording (SMDR) Incoming/Outgoing Selection

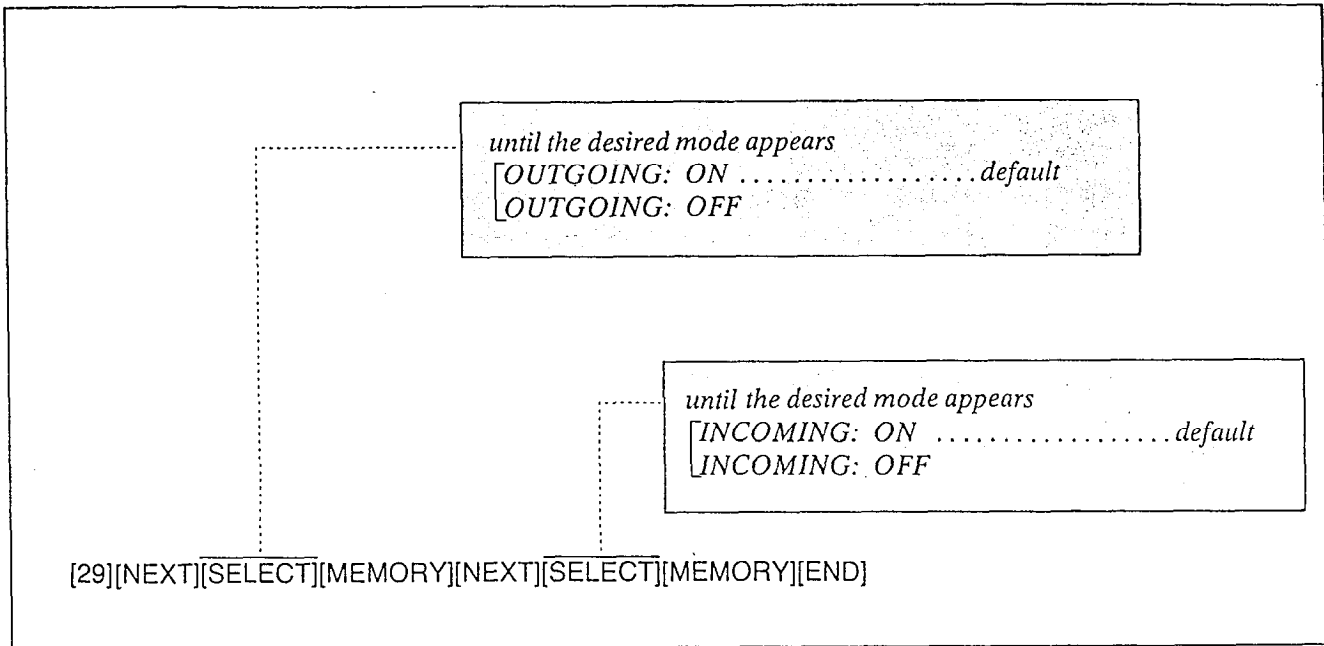

PROGRAMMING

Description

It is possible to print either outgoing outside calls, incoming outside calls or both.

- OUTGOING: ON... to print outgoing outside calls
- OUTGOING: OFF... to stop printing
- INCOMING: ON... to print incoming outside calls
- INCOMING: OFF... to stop printing

Programming

1. Dial (29).
"DURATION LOG" will be displayed.
2. Press the NEXT button.
"OUTGOING: ON" will be displayed and the "ON" will blink.
3. Press the SELECT button to alternate between the "ON" and "OFF" to select the desired mode.
4. Press the MEMORY button.
The LCD will stop blinking.
5. Press the NEXT button.
"INCOMING: ON" will be displayed and the "ON" will blink.
6. Press the SELECT button to alternate between "ON" and "OFF" to select the desired mode.
7. Press the MEMORY button.
The LCD will stop blinking.
8. To return to the initial program mode, press the END button.

Programming Table

See page 6-19.

Hold Time Reminder

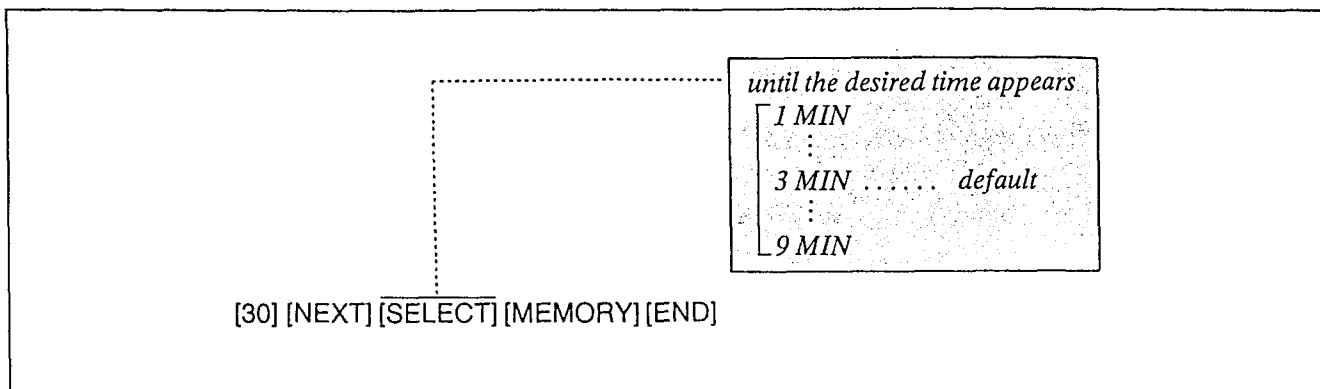

Description

A tone indication will be heard at the holding extension to remind the user that he still has a call on hold.

The reminder will sound after 3 minutes but can be changed.

There are 9 choices ranging from (1) minute to (9).

4. Press the MEMORY button.
The LCD will stop blinking.

5. To return to the initial program mode, press the END button.

Conditions

The hold time reminder is activated, even if the hold recall time set is programmed to "DISABLE".

Programming

1. Dial (30).
"AUTO HOLD ALARM" will be displayed.

2. Press the NEXT button.
"TIME: 3 MIN" will be displayed and "3" will blink.

3. Repeat pressing the SELECT button until the desired time is displayed.

Example:

4 minutes = [30] [NEXT] [SELECT]
[MEMORY] [END]

Programming Table

See page 6-20.

Hold Recall Time Set

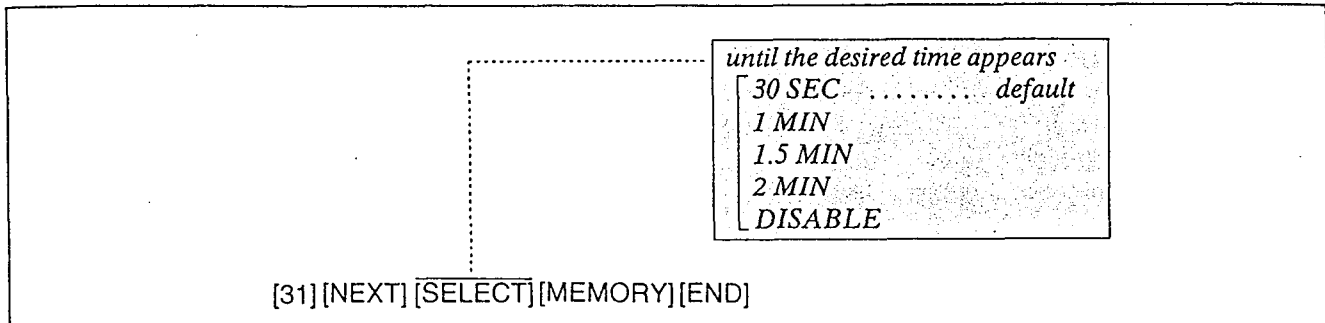

Description

When the handset of the holding extension is replaced back on call, you may have the automatic hold recall after the desired time elapses.

The hold recall time set can be removed or added at the customer's request.

Example:

1.5 minutes= [31] [NEXT] [SELECT]
[SELECT] [MEMORY][END]

Programming Table

See page 6-20.

Programming

1. Dial (31).
"HOLD RECALL TIME" will be displayed.
2. Press the NEXT button.
"TIME: 30 SEC" will be displayed and "30 SEC" will blink.
3. Repeat pressing the SELECT button until the desired time (30 SEC, 1 MIN, 1.5 MIN, 2 MIN, DISABLE) is displayed.
4. Press the MEMORY button.
The LCD will stop blinking.
5. To return to the initial program mode, press the END button.

Programmable External Paging Access Tone

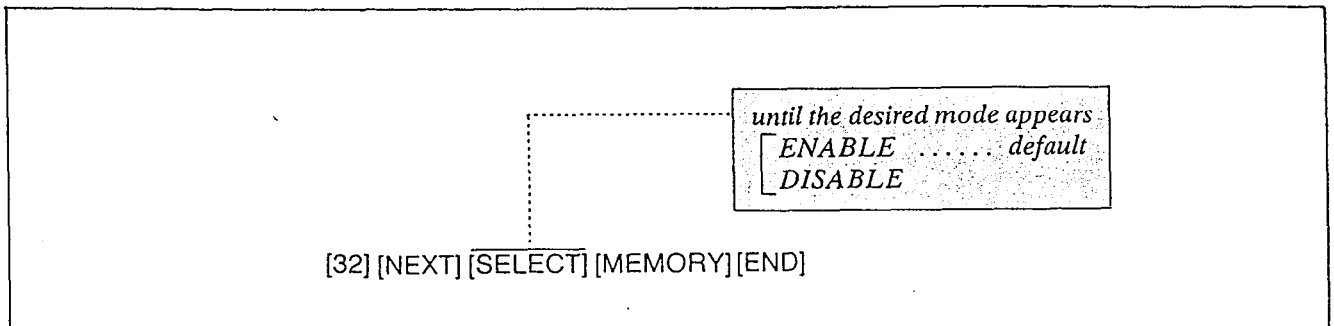

Description

The acknowledge tone that is heard after accessing the external paging can be removed or added at the customer's request.

Example:

To eliminate the paging access tone.

[32] [NEXT] [SELECT] [MEMORY][END]

Programming

1. Dial (32).
"EXT-PAG ACK-TONE" will be displayed.
2. Press the NEXT button.
"ENABLE" will be displayed and blink.
3. Press the SELECT button to alternate between ENABLE and DISABLE to select the desired mode.
4. Press the MEMORY button.
The LCD will stop blinking.
5. To return to the initial program mode, press the END button.

Programming Table

See page 6-20.

Programmable Secret Speed Dial

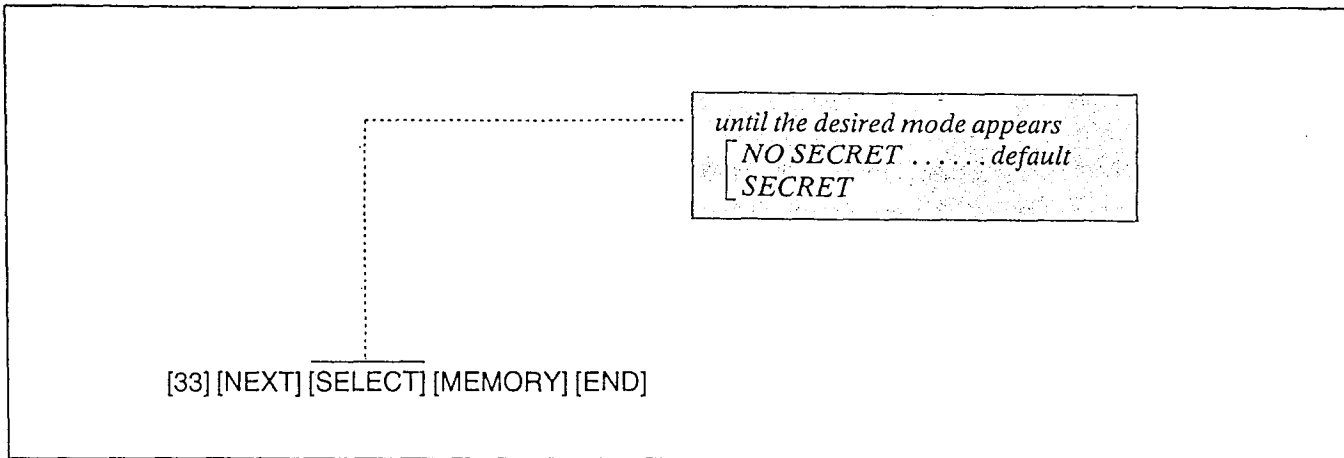

Description

When you dial on an outside line by speed dialing, the dialed number can be kept secret by not being displayed.
(The dialed number will not be displayed on the LCD of the KX-T61630/KX-T30830.)

Programming

1. Dial (33).
"SECRET SPEEDDIAL" will be displayed.
2. Press NEXT button.
"NO SECRET" will be displayed and blink.
3. Press the SELECT button to alternate between "NO SECRET" and "SECRET" to select the desired mode.
4. Press the MEMORY button.
The LCD will stop blinking.
5. To return to the initial program mode, press the END button.

Programming Table

See page 6-20.

Hookswitch Flash Timing

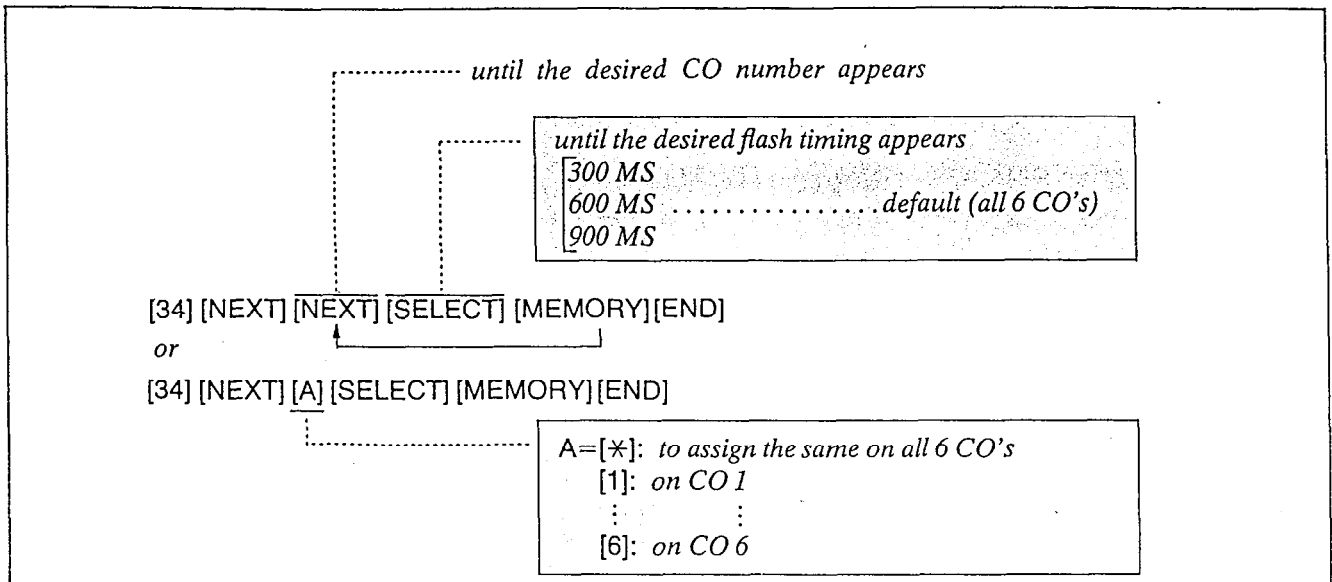

Description

The timing of the hookswitch flash signal must be within the requirements from your Central Office.

There are three choices available 0.3, 0.6 or 0.9 second.

Programming

1. Dial (34).
"FLASH TIME SET" will be displayed.
2. Press the NEXT button.
"ENTER CO NO" will be displayed.
3. Press the NEXT button.
"CO 1: 600 MS" will be displayed and "600 MS" will blink.
4. Repeat pressing the SELECT button until the desired value is displayed.
5. Press the MEMORY button.
The LCD will stop blinking.
6. Repeat steps 3 to 5, to set the hookswitch timing of the other CO's.
7. To return to the initial program mode, press the END button.

Conditions

- When you start the programming from step 1, you may dial the desired CO number instead of the NEXT button at step 3.
- The PREV button allows you to go to the previous CO for displaying the hookswitch flash timing.

Example:

- 0.3 sec on all 6 CO=
 [34] [NEXT] [*] [SELECT] [SELECT] [MEMORY] [END]

Programming Table

See page 6-20.

Disconnect Time

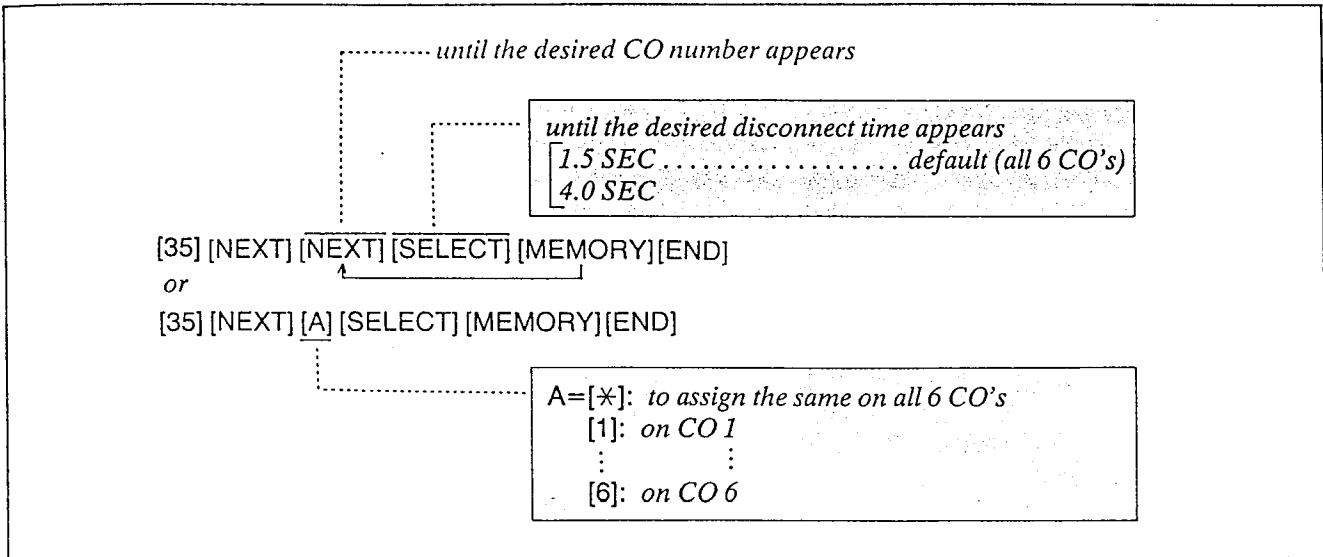

Description

A certain amount of time is needed for an outside call to be released, this is necessary so that a new call may be attempted after disconnecting with the previous call.

There are two choices available, 1.5 and 4.0 seconds.

The time you select must be longer than the requirements from your Central Office or host PBX.

Programming

1. Dial (35).
"DISCONNECT TIME" will be displayed.
2. Press the NEXT button.
"ENTER CO NO" will be displayed.
3. Press the NEXT button.
"CO 1: 1.5 SEC" will be displayed and "1.5 SEC" will blink.
4. Press the SELECT button to alternate between 1.5 sec and 4.0 sec.
5. Press the MEMORY button.
The LCD will stop blinking.

6. Repeat steps 3 to 5, to set the disconnect time for the other CO's.

7. To return to the initial program mode, press the END button.

Conditions

- When you start the programming from step 1, you may dial the desired CO number instead of the NEXT button at step 3.
- The PREV button allows you to go to the previous CO for displaying the disconnect time.

Example:

- 4.0 sec on all 6 CO=
[35] [NEXT] [*] [SELECT] [MEMORY] [END]

Programming Table

See page 6-20.

Calling Party Control (CPC) Signal

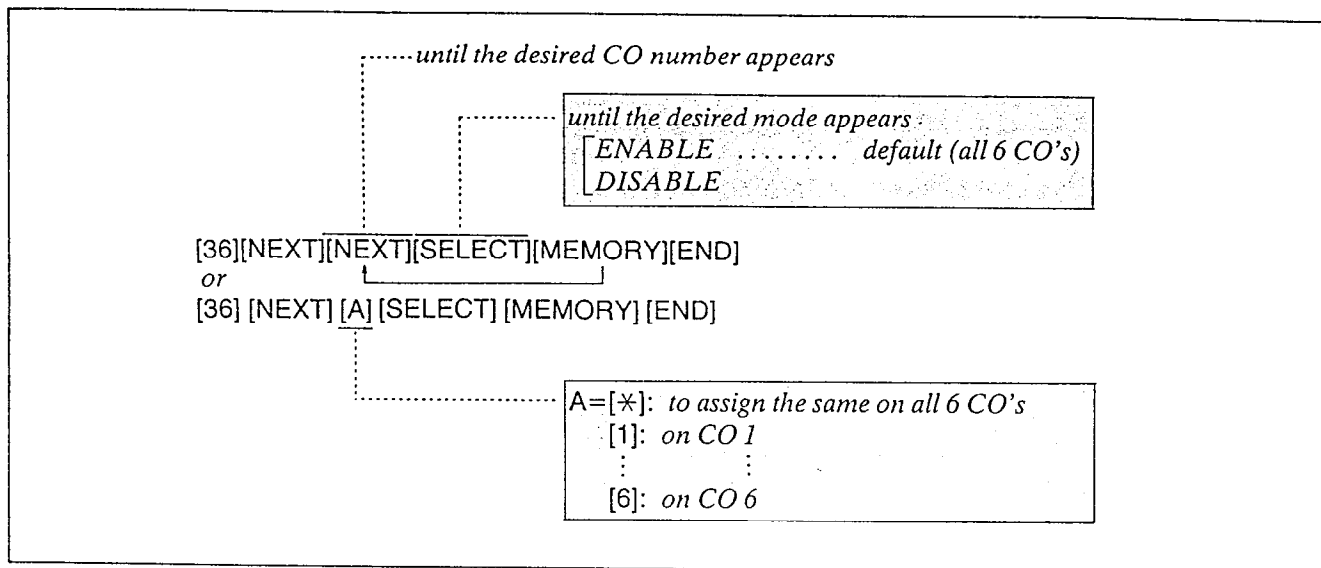

Description

To detect that an outside party has hung up and then terminate the outside (after a conversation, conference etc.) a CPC signal is needed. CPC signal detection can be removed or added at customer's request.

Programming

1. Dial (36).
"CPC DETECTION" will be displayed.
2. Press the NEXT button.
"ENTER CO NO" will be displayed.
3. Press the NEXT button.
"CO 1: ENABLE" will be displayed and "ENABLE" will blink.
4. Press the SELECT button, to alternate between ENABLE and DISABLE to select the desired mode.
5. Press the MEMORY button.
The LCD will stop blinking.

6. Repeat steps 3 to 5, to program the assignment of the other CO's.

7. To return to the initial program mode, press the END button.

Conditions

- When you start the programming from step 1, you may dial the desired CO number instead of the NEXT button at step 3.
- The PREV button allows you to go to the previous CO for displaying the calling party control signal selection.

Programming Table

See page 6-20.

DSS Button Mode

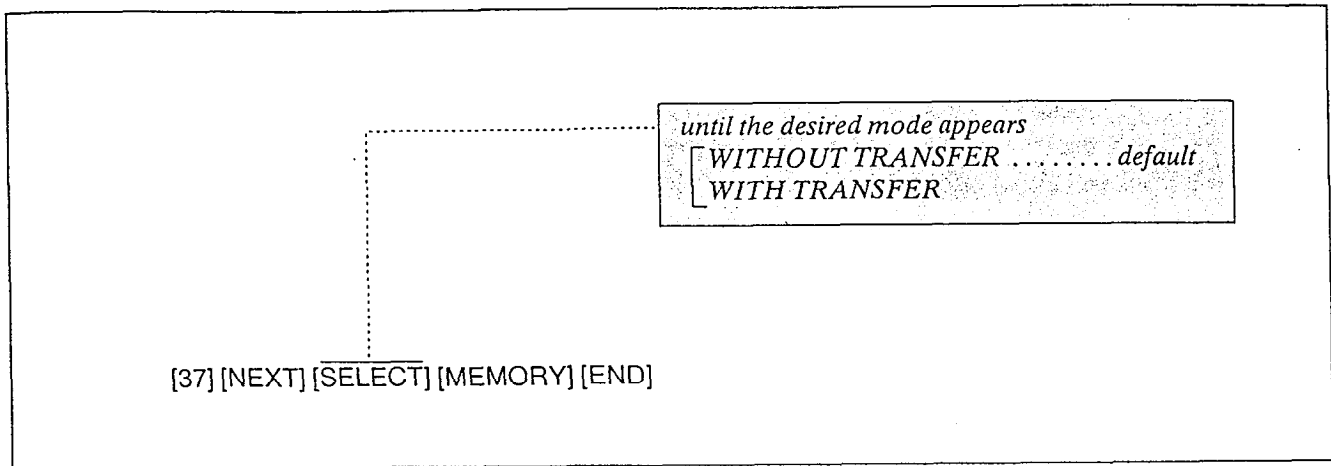

Description

Outside calls can be transferred to any extension manually.

- “WITHOUT TRANSFER” mode you can transfer outside call by pressing the TRANSFER button and then DSS button.
- “WITH TRANSFER” mode you can transfer outside call by only pressing the DSS button.

Programming

1. Dial (37).
“DSS BUTTON MODE” will be displayed.
2. Press the NEXT button.
“WITHOUT TRANSFER” will be displayed and blink.
3. Press the SELECT button to alternate between “WITHOUT TRANSFER” and “WITH TRANSFER” to select the desired mode.
4. Press the MEMORY button.
The LCD will stop blinking.
5. To return to the initial program mode, press the END button.

Conditions

- Intercom calls can be transferred by pressing the TRANSFER button and then DSS button regardless of the mode setting.

Programming Table

See page 6-21.

Transfer Recall Time

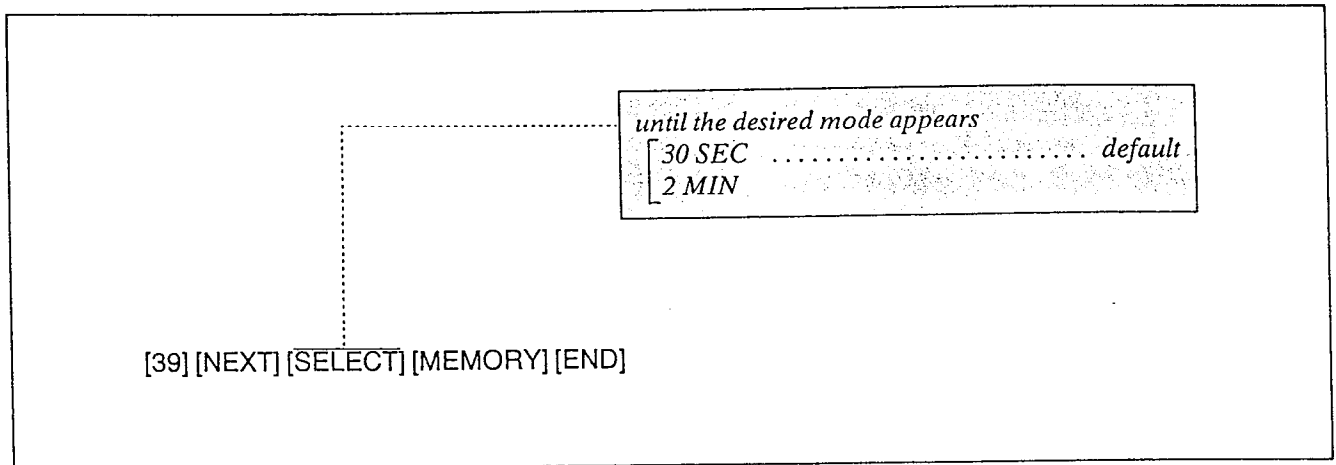

Description

When a call is transferred to any extension, if other extension does not receive the transferred call within 30 seconds, the call will return to you.

The time may be changed to 2 minutes.

Programming

1. Dial (39).
"XFER RECALL TIME" will be displayed.
2. Press NEXT button.
"30 SEC" will be displayed and blink.
3. Press the SELECT button to alternate between "30 SEC" and "2 MIN" to select the desired mode.
4. Press the MEMORY button.
The LCD will stop blinking.
5. To return to the initial program mode, press the END button.

Programming Table

See page 6-21.

M3/FWD Selection (for KX-T30850, KX-T61650)

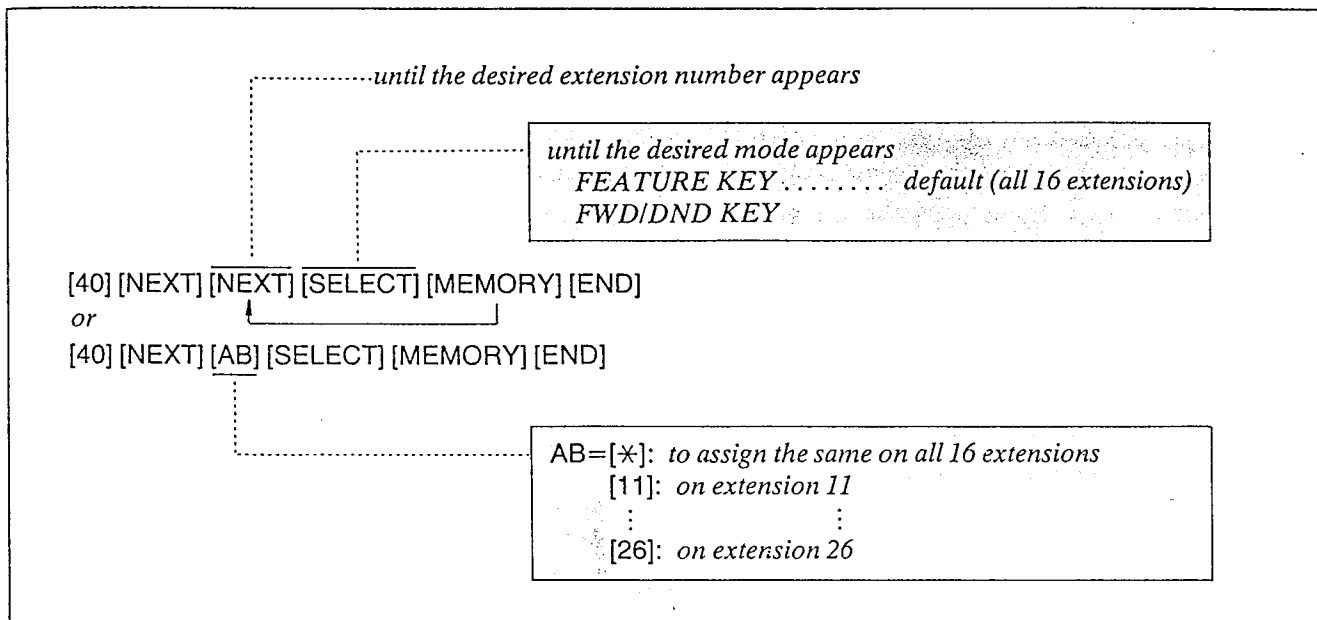

Description

3 programmable feature (F1, F2, F3) buttons are provided with the proprietary telephones, KX-T61650 and KX-T30850, and only the "F3" button can be changed from programmable feature button to call forwarding (see page 4-35 for operation)/do not disturb (see page 4-37)/account code (see page 4-25) button.

"FEATURE KEY" mode...

programmable feature function

"FWD/DND KEY" mode...

call forwarding/do not disturb/account code function

4. Press the SELECT button to alternate between FEATURE KEY and FWD/DND KEY to select the desired mode.

5. Press the MEMORY button.
The LCD will stop blinking.

6. To return to the initial program mode, press the END button.

7. Repeat steps 1 to 6, to program call forwarding/do not disturb/account code button of the other extensions.

Programming

1. Dial (40).
"M3/FWD SELECTION" will be displayed.
2. Press the NEXT button.
"ENTER EXT NO" will be displayed.
3. Dial the extension number to which the KX-T61650 or KX-T30850 is connected.

Example:

When dialing 20, the LCD will show "20:FEATURE KEY" and the "FEATURE KEY" will blink.

Conditions

- You may repeat pressing the NEXT button until the extension number to which the KX-T61650 or KX-T30850 is connected is displayed instead of the dialing the extension number at step 3.
- The PREV button allows you to go to the previous extension for displaying the M3/FWD selection.

Programming Table

See page 6-21.

DETAILED FEATURE DESCRIPTION AND OPERATION FOR EMSS PROPRIETARY TELEPHONE (KX-T61630, KX-T61620, KX-T61650, KX-T30830, KX-T30820, KX-T30850)

To operate this system, after making program changes, set the System Program Switch located on the KX-T61610 (Electronic Modular Switching System) to the SET position.

To Make Calls

When the unit is unused, the Liquid Crystal Display will show the month, day and the present time.

Inter Office Calling (Intercom)

Using the Handset



LIFT THE
HANDSET

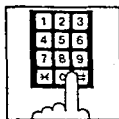

DIAL THE
EXTENSION
NUMBER
(11 through 26)



TALK



HANG UP

Hands-free

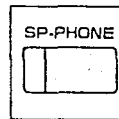

PRESS
"SP-PHONE"

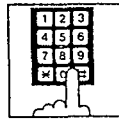

DIAL THE
EXTENSION
NUMBER
(11 through 26)



TALK

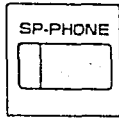

PRESS
"SP-PHONE"

- You may press the ICM button instead of the first SP-PHONE button.
- ICM—Intercom
- CO—Central Office

Description

Station to station dialing within the KX-T61610 system.

Operation

Using the handset

1. Lift the handset.
2. Dial the extension number (11 through 26).
3. Start talking
4. Hang up upon completion of the conversation.

Hands-free

1. Press the SP-PHONE or ICM button.
2. Dial the extension number (11 through 26).
3. Start talking
4. Press the SP-PHONE button again after completion of the conversation.

Conditions

- When a called party has the KX-T61630/ KX-T30830 equipped with an LCD, the extension number of the calling party will be displayed on the LCD of the called party.
- The extension number of the calling party will be displayed on the LCD of the KX-T61630/ KX-T30830.
- The ICM indicator will be lit green while using the unit.
- The KX-T61650 or KX-T30850 will not function for hands-free mode.

Outward Dialing

Automatic Line Access

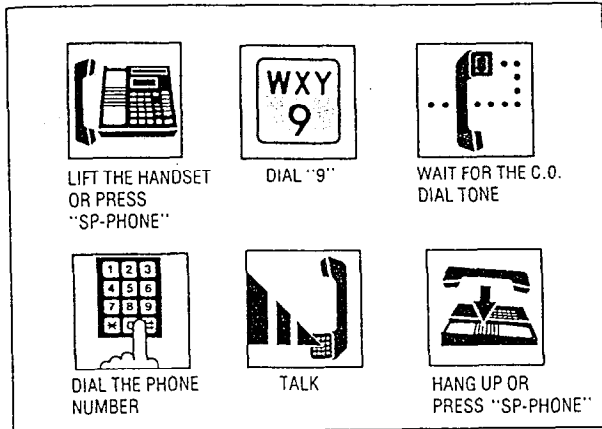

Description

Each extension can automatically select an idle CO (Central Office) line within the KX-T61610.

Operation

1. Lift the handset or press the SP-PHONE button.
2. Dial (9).
Dial tone from CO (Central Office) will be heard.
 - The CO indicator will be lit green at your extension and lit red at other extensions.
3. Dial the phone number.
4. Start talking.
5. Hang up or press the SP-PHONE button upon completion of the conversation.

Conditions

- The 9 dialed, will be displayed on the LCD of the KX-T61630/KX-T30830 and you will hear following.
- Dial tone from the CO: indicates that the CO line is captured.
- Busy tone: indicates that the six CO lines are busy.
- Reorder tone: indicates that the extension is denied access to an outside line.

Individual Line Access

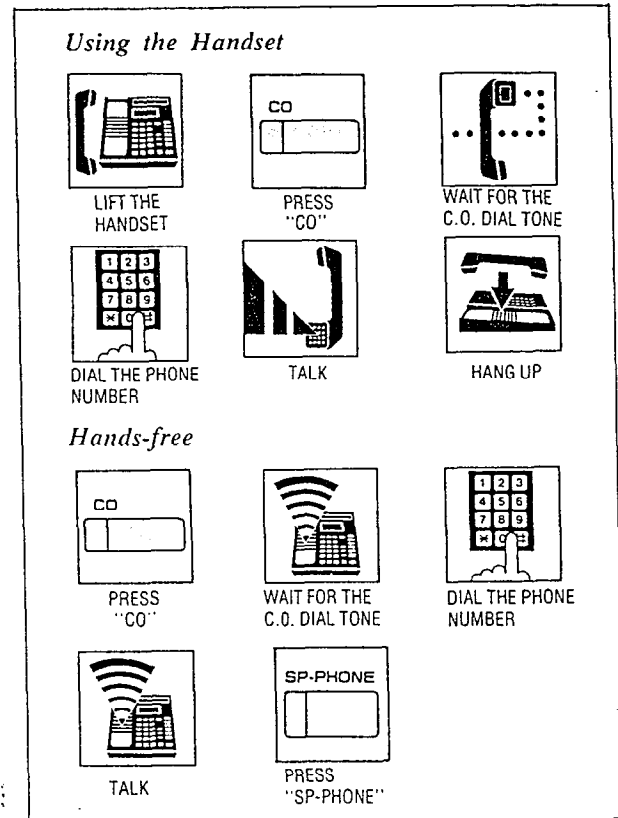

Description

Any of the 6 CO's may be directly selected.

Operation

Using the handset

1. Lift the handset.
2. Press the CO button.
Dial tone from CO will be heard.
3. Dial the phone number.
4. Start talking.
5. Hang up.

Hands-free

1. Press the CO button.
Dial tone from CO will be heard.
2. Dial the phone number.
3. Start talking.
4. Press the SP-PHONE button.
 - The phone number dialed will be displayed on the LCD of the KX-T61630/KX-T30830.
 - You can not use the CO button whose indicator is lit (red) as this CO line is use.
 - The KX-T61650 or KX-T30850 will not function for hands-free mode.

Outward Dialing (cont.)

Individual Line Access

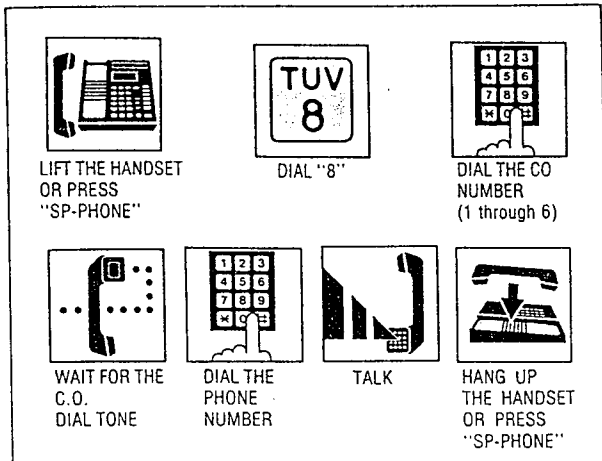

Description

Any of the 6 CO lines may be selected by dial access.

Operation

1. Lift the handset or press the SP-PHONE button.
2. Dial (8) and the CO number (1 through 6). Dial tone from the CO (Central Office) will be heard.
3. Dial the phone number.
4. Start talking.
5. Hang up or press the SP-PHONE button.

Conditions

- The phone number dialed will be displayed on the LCD of the KX-T61630/KX-T30830.
- Individual line access codes
 - Dial 81 for CO 1
 - Dial 82 for CO 2
 - Dial 83 for CO 3
 - Dial 84 for CO 4
 - Dial 85 for CO 5
 - Dial 86 for CO 6

Each extension can access a new CO line without hanging up.

While having a conversation,

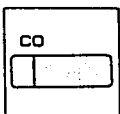

PRESS ANOTHER "CO"

- The original conversation will be terminated and a new CO line will be accessed.

Speed Dialing

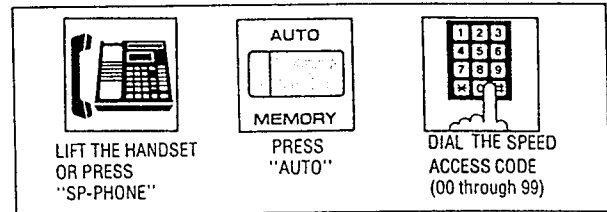

Description

There are 100 memory locations of system speed dialing available.

Operation

1. Lift the handset or press the SP-PHONE button.
2. Press the AUTO button.
3. Dial the speed access code.
 - You may press the CO button to select the CO line directly after lifting the handset or press the SP-PHONE button.

Condition

- The dialed number will be displayed on the LCD of the KX-T61630/KX-T30830.
- Continuous use of speed dialing is possible.
 - ex. [AUTO] [0] [0] [AUTO] [0] [1]
- Chaining together two or more memory locations.
- Combinations of speed dialing, one touch dialing and manual dialing is possible.

One Touch Dialing

Programming

- Be sure the handset is in the cradle and the SP-PHONE or MONITOR button is OFF.
- Set the MEMORY switch of the KX-T61630, KX-T61620, KX-T61650, KX-T30830, KX-T30820 or KX-T30850 to "PROGRAM".

Storage

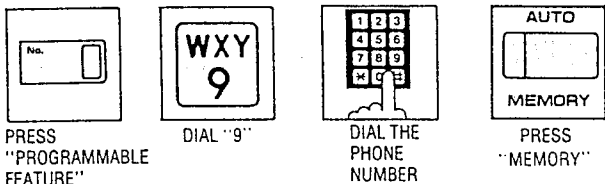

- You may dial 81 through 86 instead of 9.
 - 9 Each extension can automatically select an idle CO line.
 - 81 through 86.. Each extension can select a designated CO line.

9 or 81 through 86 must be dialed for storage.

To Erase after Programming

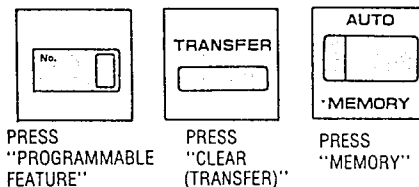

- The TRANSFER button is used as the CLEAR button.

After programming all the numbers, return the MEMORY switch to the "SET" position.

To Correct an Error while Programming



PRESS "CLEAR (TRANSFER)" INSTEAD OF "MEMORY"

- After pressing the CLEAR button, reprogram the correct number.
- The TRANSFER button is used as the CLEAR button.

Dialing



LIFT THE HANDSET OR PRESS "SP-PHONE"

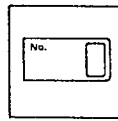

"PRESS PROGRAMMABLE FEATURE"

- You may press the CO button to select the CO line directly after lifting the handset or press the SP-PHONE button.

To Change a Stored Number

Repeat "Storage" above.

To Confirm a Stored Number

Repeat programming the same number into the same station.

When the MEMORY button is pressed, a beep will be heard.

- two beeps storage is correct
 - one beep storage is incorrect
- Repeat the procedure of programming.

Description

There are 12 memory locations for automatic dialing available. Up to 32 digits can be stored into each of the 12 memory locations. Pushing the "*", "#", "-", "FLASH" or "PAUSE" button counts as 1 digit.

- For your convenience, program private phone numbers into the KX-T61630, KX-T61620, KX-T61650, KX-T30830, KX-T30820 or KX-T30850.

Programming

Be sure the handset is in the cradle and the SP-PHONE or MONITOR button is OFF.

1. Set the MEMORY switch to "PROGRAM". "PROGRAM MODE" will be displayed.
2. Press a programmable feature button.
The LCD will show "M01: NOT STORED" when nothing is stored in the programmable feature button "01".
When automatic line access number 9 and the phone number 123-456-7890 has been stored, "M01: -123-456-7890" will be displayed.
3. Enter the line access number.
 - 9: automatic line access number
 - 81: line access number of CO 1
 - 82: line access number of CO 2
 - 83: line access number of CO 3
 - 84: line access number of CO 4
 - 85: line access number of CO 5
 - 86: line access number of CO 6
4. Enter the phone number.
 - You may enter punctuations during a phone number.
The SNR button is used as the "-" button.
 - To erase a wrong entry, press the CLEAR button.
The TRANSFER button is used as the CLEAR button.
5. Press the MEMORY button.
The MEMORY indicator will be lit.
6. Repeat steps 2 to 5, to program on other programmable feature buttons.
7. After programming all the numbers, return the MEMORY switch to the "SET" position.
The MEMORY indicator will go out.

Dialing

1. Lift the handset or press the SP-PHONE button.
2. Press a programmable feature button.
 - You may press the CO button to select the CO line directly after lifting the handset or press the SP-PHONE button.

Conditions

- Use the "⇨", or "⇩" button for scrolling the display from side to side.
- The dialed phone number will be displayed on the LCD of the KX-T61630/KX-T30830.
- The combinations of speed dialing, one-touch dialing and manual dialing is possible.
- The line access number (9 or 81 through 86) should be stored.
- Continuous use of one touch dialing is possible.
Example:
[01] [02]
In this case, programmable feature button "02" should not include the line access number.
- When dialing, the pause is automatically entered after line access number (9 or 81 through 86).
- Features that can be accessed by using the dialing button also can be programmed into memory.
Refer to "One Touch Access for System Features" page 4-23.

Examples:

Automatic line access number 9 and phone number 123-4567 into the programmable feature button "01".

Programming

Set the MEMORY switch to "PROGRAM" position.
[01] [9] [123-4567] [MEMORY]
Return the MEMORY switch to "SET" position.

Dialing

- Lift the handset.
Dial [01]
- You may press the CO button to select the CO line directly after lifting the handset.

Calling Doorphone

Calling doorphone 1



LIFT THE HANDSET
OR PRESS
"SP-PHONE"

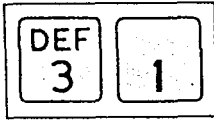

DIAL "31"



WAIT FOR THE
CONFIRMATION
TONE AND
THEN TALK.

Calling doorphone 2



LIFT THE HANDSET
OR PRESS
"SP-PHONE"

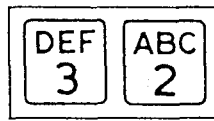

DIAL "32"



WAIT FOR THE
CONFIRMATION
TONE AND
THEN TALK

Description

Up to two doorphones (KX-T30865) can be connected to the KX-T61610.

Operation

Dialing to the doorphones

1. Lift the handset or press the SP-PHONE button.
2. Dial (31) for calling doorphone 1.
Dial (32) for calling doorphone 2.
"DOOR 1" or "DOOR 2" will be displayed.
3. Wait for the confirmation tone and then start talking.
4. Hang up or press the SP-PHONE button upon completion of the conversation.

Conditions

- The features, for instance, hold, transfer and so on, can not be activated by the doorphone.

Distinctive Dial Tone

Description

A distinctive dial tone will be heard from the handset if the extension user has previously activated a special feature.

Operation

None

Conditions

There are two types of dial tones.

Dial tone 1: ordinary dial tone

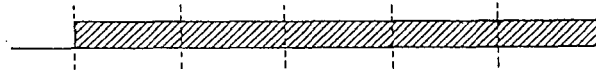

Dial tone 2: when any of the following features is activated:

Do not Disturb.
Dial Call Pickup Deny
Call Forwarding.
Data Line Security.
Background Music

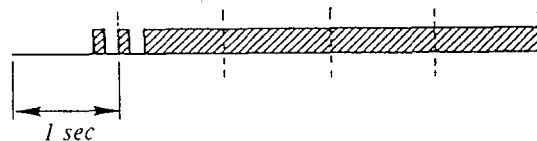

When a Line is Busy

Automatic Call Back Busy—(Camp-on)

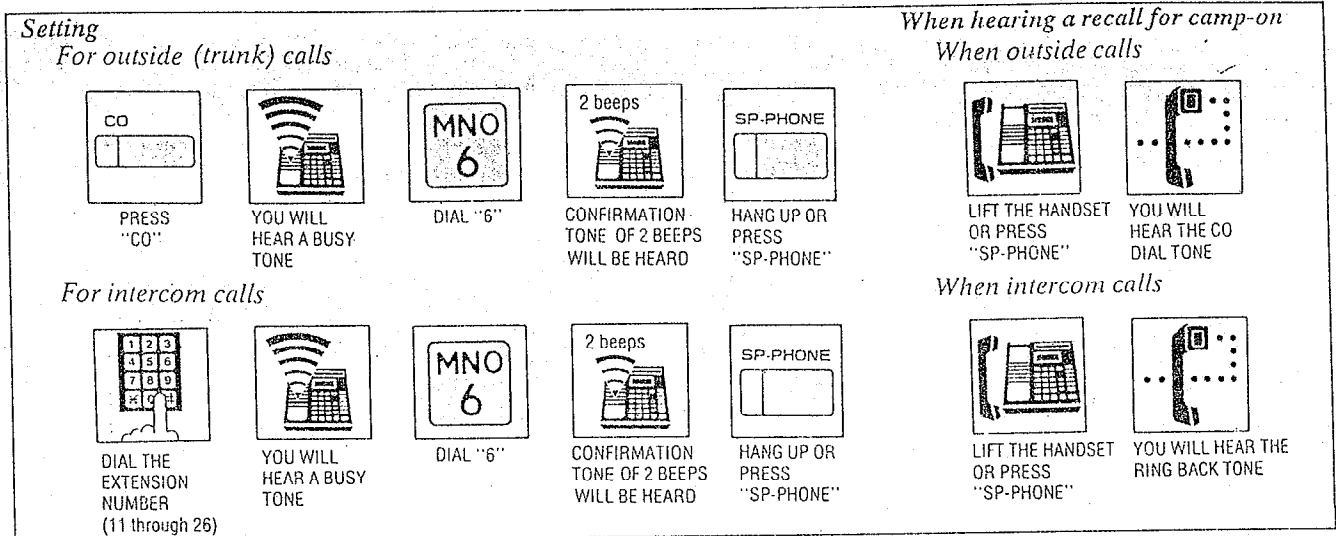

Description

If the intercom extension or outside line you have dialed is busy, you will be automatically called back when the extension or the outside line becomes free using this function. This feature is also known as camp-on.

Operation

Setting

1. Lift the handset or press the SP-PHONE button.
2. For intercom calls, dial the extension number.
For outside calls, press the CO button.
3. Dial (6) after a busy tone is heard.
4. Wait for the confirmation tone.
"CAMP ON CO" or "CAMP ON EXT" will be displayed.

5. Hang up or press the SP-PHONE button.

When hearing a recall for camp-on;

Lift the handset or press the SP-PHONE button.

- When using an intercom call, you will hear the ring back tone.
- When using an outside call, you will hear the CO dial tone.

Conditions

- Lifting the handset (or pressing the SP-PHONE button) during the camp-on mode will cause the camp-on feature to be cancelled.
- An extension may be the recipient of more than one call back busy, the call backs will be executed in the order of their arrival.
- If a call back is not answered at the originating extension within 10 seconds, the call back will be cancelled.

Recall for camp-on

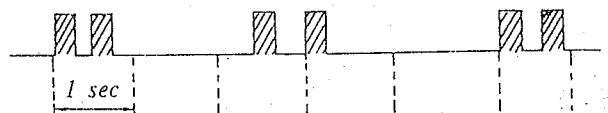

Busy Station Signaling

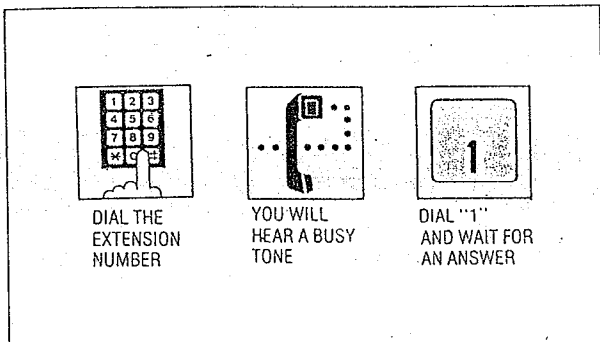

Description

If the extension you have dialed is busy, you can inform that extension that another intercom call is waiting by three beeps.

For use of this feature, the other extension is required to be set for this feature beforehand in the KX-T61610.

Operation

1. Lift the handset or press the SP-PHONE button.
2. Dial the extension number.
3. When you will hear a busy tone, dial (1) and wait for an answer.

Conditions

- To answer your signal, see "Call Waiting" on page 4-16.
- If the other party is using data equipment, you may not be able to use this feature.
- If a busy tone is heard after dialing 1, it indicates that the other party has not been set with this feature.

Last Number Redial

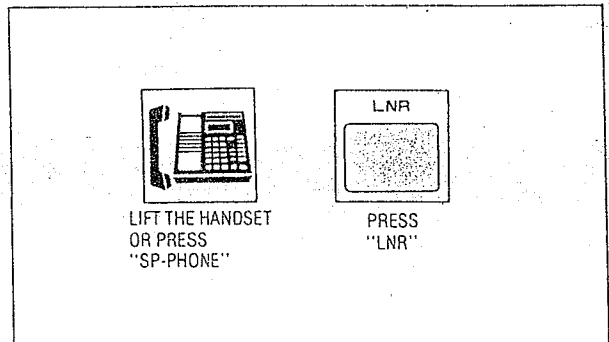

Description

The last phone number dialed on an outgoing call (CO line) can be redialed.

Operation

1. Lift the handset or press the SP-PHONE button.
 2. Press the LNR button.
- You may press the CO button to select the CO line directly after lifting the handset or press the SP-PHONE or MONITOR button.

Conditions

- Up to 32 digits can be stored and redialed. Pushing the "*" "#" or "PAUSE" button counts as 1 digit.
- When calling or while in the conversation mode, pressing the LNR button will cause the redial to operate after about 3 seconds.

To Receive Calls

Answer

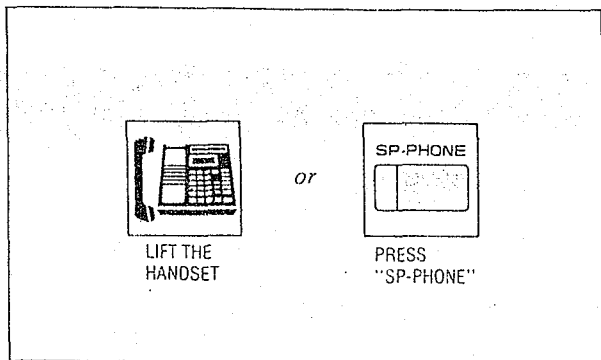

Automatic Answer-Intercom

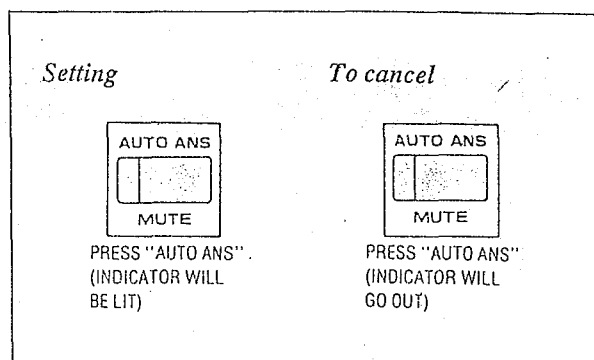

Operation

Lift the handset or press the SP-PHONE button.

- When the "Automatic Answering Selection" feature has been selected to the "manual" mode in the KX-T61610 and an outside call is received, you must lift the handset and then press the CO button whose indicator is flashing (red color) quickly.
- When receiving an intercom call, you may press the ICM button whose indicator is flashing quickly and talk. (Hands-free mode)
- When receiving an outside call, you may press the CO button whose indicator is flashing red quickly and talk. (Hands-free mode)
- If any incoming calls from the Central Office are received at the same time except preferred CO line, you must lift the handset and then press the CO button whose indicator is flashing (red color) quickly.

Conditions

- If a call reaches through the CO line to which the CO-line number is not assigned, the ICM indicator will flash quickly. And the CO call can be received by pressing the ICM or the SP-PHONE button or lifting the handset.

Description

Allows extension user to answer an intercom call in the automatic hands-free mode without any operation when receiving an intercom call.

Operation

1. For setting, press the AUTO ANS button. The AUTO ANS indicator will be lit.
2. For cancellation, press the AUTO ANS button again. The AUTO ANS indicator will go out.

Description

- This feature is required to be set beforehand while the unit is not in use.
- The KX-T61650 or KX-T30850 will not function for Automatic Answer.

Dial Call Pickup

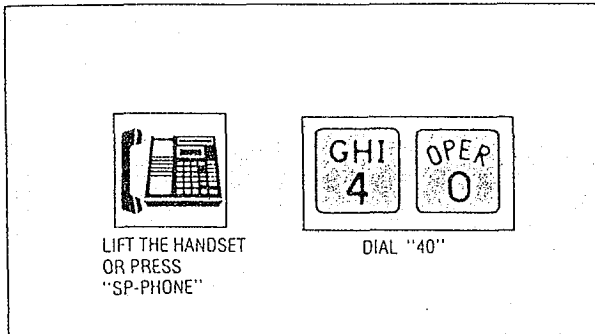

Directed Call Pickup

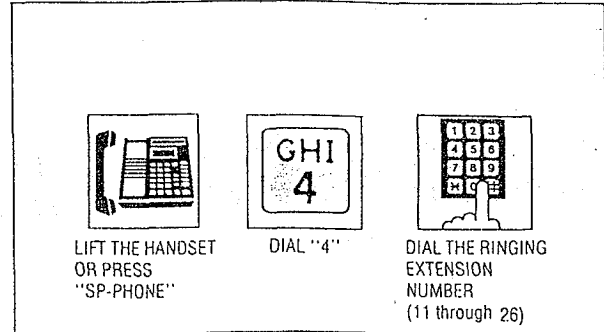

Description

An extension user can answer any ringing extension within their own pickup group.

Operation

1. Lift the handset or press the SP-PHONE button.
2. Dial (40) and wait for the confirmation tone.
3. Start talking.

Conditions

- Dial Call Pickup will work for incoming calls (intercom, outside and doorphone) but will not work for camp-on recall and hold recall.
- If a ringing extension is outside the pickup group or is in the dial call pickup denied mode, then a reorder tone will be heard through the use of this feature.
- Refer to "Dial Call Pickup Group Assignment" on page 3-33.
- Dial Call Pickup can use with the present call placed on hold.

Description

An extension may answer an incoming call that is ringing at another extension regardless of the pickup group.

Operation

1. Lift the handset or press the SP-PHONE button.
2. Dial (4) and then the extension number (11 through 26) at which call is ringing.
3. Wait for confirmation tone and then start talking.

Conditions

- It is possible to answer calls outside your assigned pickup group.
- Directed Call Pickup can use with the present call placed on hold.

Example:

Mr Brown's extension number is 16.
He is now out of the office.
Mark receives the call instead of Mr. Brown with the telephone on his desk (extension 15).

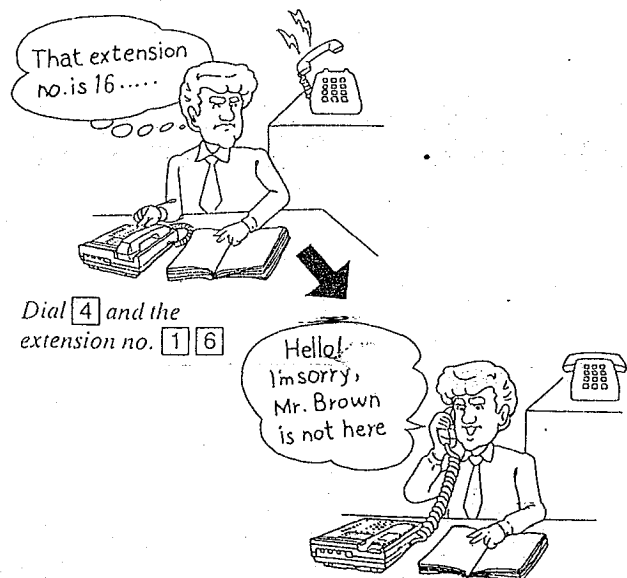

Call Park Retrieve

To retrieve a parked call at any extension



LIFT THE
HANDSET
OR PRESS
"SP-PHONE"



DIAL "5"

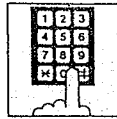

DIAL PARKED
EXTENSION
NUMBER

Description

Allows any extension user to retrieve a call (intercom or outside) on hold at any extension.

Operation

When an intercom or outside call is on hold.

1. Lift the handset or press the SP-PHONE button at any extension.
2. Dial (5) and the extension number of the phone on which the call is placed on hold. (Connection is now made with the party who was on hold.)
3. Wait for the confirmation tone and then start talking.

■ Even when several outside calls are placed on hold simultaneously, you can retrieve the desired outside call from another extension as following.

1. Dial (58).
2. Dial the CO number (1 through 6).

Conditions

- Call park retrieving is possible regardless of the handset position of the phone which has placed the call on hold.
- If the extension that you want to retrieve the call park has several calls on hold, only the last call on hold will be retrieved.

Example:

Mark is talking with extension 15 on his desk, and then moves to another room placing the call on hold.

He resumes the conversation using another extension.



Press the HOLD button, hang up and then go to Mr. Jay's office.



Dial 5 and the extension number 15 at Mr. Jay's office.

Doorphone

To answer a doorphone



LIFT THE
HANDSET

or



PRESS
"SP-PHONE"

Operation

Lift the handset or press the SP-PHONE button.

Conditions

- If calls from doorphones are not answered within 15 seconds, the calls will be cancelled.
- Ring from doorphone.

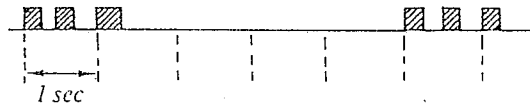

- Each extension has to be programmed for receiving from doorphones. See "Programmable Doorphone" on page 3-32.

Distinctive Ring Tone

Description

A different ringing pattern is used to distinguish intercom calls from incoming outside calls.

Operation

None

Conditions

Automatic ring back for the camp on feature will ring differently from the ringing on intercom, outside, and doorphone calls.

Incoming outside calls (including outside hold recall)

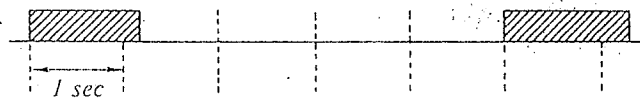

Intercom calls (including intercom hold recall)

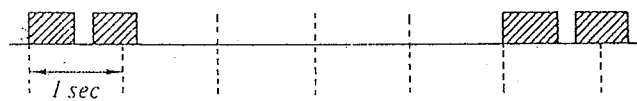

Doorphone calls

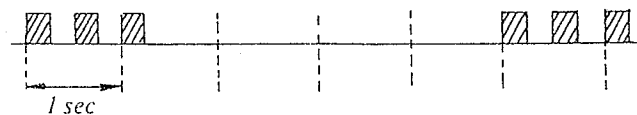

While Having a Conversation

Call on Hold

To place a call on hold:

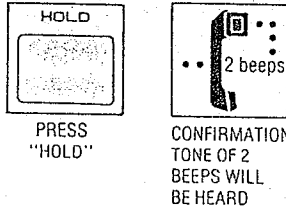

PRESS "HOLD"
CONFIRMATION TONE OF 2 BEEPS WILL BE HEARD

To retrieve:

(Outside calls on hold)

- at the holding extension

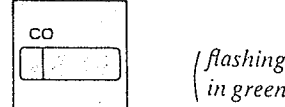

CO (flashing in green)
PRESS "CO"

- from another extension

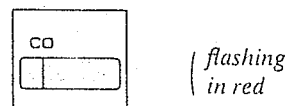

CO (flashing in red)
PRESS "CO"

(Intercom call on hold)

- at the holding extension

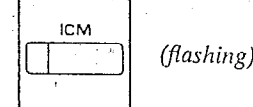

ICM (flashing)
PRESS "ICM"

- from another extension

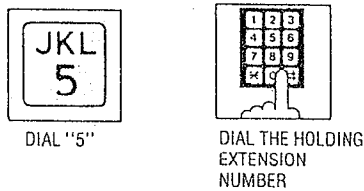

JKL 5
DIAL "5"
DIAL THE HOLDING EXTENSION NUMBER

Description

If you wish to leave your phone unattended but want the caller you are in conversation with to wait, call hold may be used. Outside or intercom calls may be placed on hold.

Calls on hold can be released by other extensions.

Operation

1. You are in conversation with an outside or internal party.

2. Press the HOLD button.

The indicator of CO or ICM button which is on hold will flash slowly (green color).

The confirmation tone of 2 beeps will be heard.

To Retrieve at the holding extension, press the CO or ICM button (flashing green). The indicator light will return to a steady green.

To Retrieve from another extension, press the CO button (flashing red).

or

■ dial (5) and then the extension (11 through 26) or CO (81 through 86) number of the phone on which the call was placed on hold.

[5] [AB]

---AB=11 through 26 (extension)

or

AB=81 through 86 (CO)

- The green flashing indicator at the held extension will turn to red.

- Refer to "Call Park Retrieve" on page 4-11.

Conditions

- An Intercom hold can be activated on one extension only.

- An Outside call hold can be activated on six CO's.

- If a call is on hold for more than 30 minutes, a hold time reminder will be sounded and the call will be terminated automatically.

A hold time reminder is sounded through the built-in speaker of the extension.

- Calls on hold will be recalled either after 30 seconds, 1 minute, 1 minute and 30 seconds or 2 minutes, once handset is replaced (or the SP-PHONE button is pressed).

If hold recall time is set to "DISABLE", it will not be recalled.

Refer to "Hold Recall Time Set" on page 3-46.

- The hold time reminder is activated, even if the hold recall time set is programmed to "DISABLE".

- When lifting the handset (or press the SP-PHONE button):

before recalling... A dial tone will be heard with the call on hold.

You may dial another phone number.

while recalling... Only the first call on hold will be released and entered into the conversation mode.

Call on Exclusive Hold

To place a call on exclusive hold:

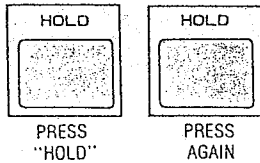

To retrieve:

(Outside calls on hold)

(Intercom call on hold)

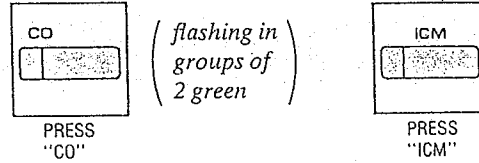

Description

An intercom or outside call placed on exclusive hold can not be released by any extension other than the phone which has placed the call on hold.

Operation

1. You are in conversation with an outside or internal party.
2. Press the HOLD button.
The indicator of CO or ICM button which is on hold will flash slowly (green color).
A confirmation tone of 2 beeps will be heard.
3. Press the HOLD button, again.
The indicator will flash in groups of 2 (green color).
4. To retrieve, press the ICM button or the CO button whose indicator is flashing in groups of 2 (green color).
The indicator on the ICM or CO button will return to a steady green.

Conditions

- An Intercom hold can be activated on one extension only.
- An Outside call hold can be activated on six CO's.
- If a call is on hold for more than 30 minutes, a hold time reminder will be sounded, and the call will be terminated automatically.
A hold time reminder is sounded through the built-in speaker of the extension.
- Calls on hold will be recalled either after 30 seconds, 1 minute, 1 minute and 30 seconds or 2 minutes, once handset is replaced (or the SP-PHONE button is pressed). If hold recall time set is set to "DISABLE", will not be recalled. Refer to "Hold Recall Time Set" on page 3-46.
- The hold time reminder is activated, even if the hold recall time set is programmed to "DISABLE".
- When lifting the handset (or press the SP-PHONE button):
before recalling... A dial tone will be heard with the call on hold.
You may dial another phone number.
while recalling... Only the first call on hold will be released and entered into the conversation mode.

Conference

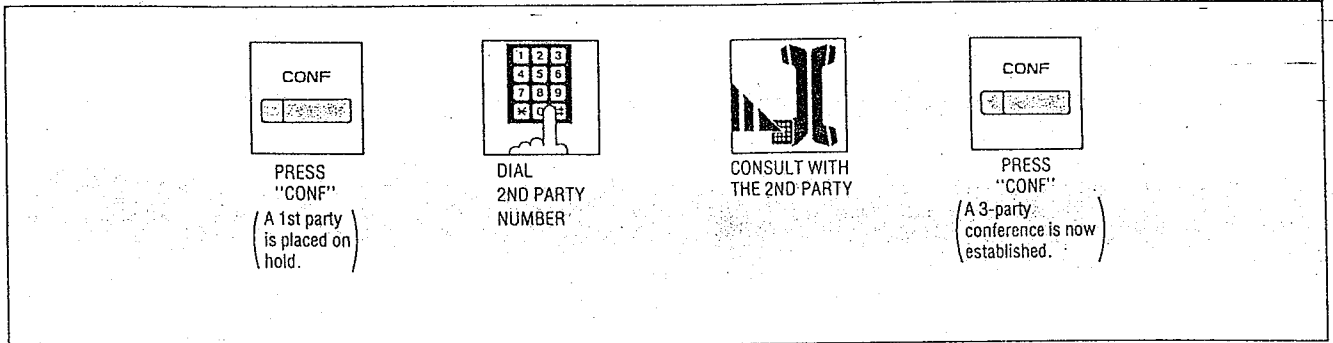

Description

Allows for up to a three party conference, (2-outside/1-inside) (1-outside/2-inside) or (3-inside).

Operation

1. Press the CONF button, to place the first party on hold.
2. Dial the number of the second party.
If second party does not answer, press the CO button of the outside party concerned, or the ICM button to return to the first party.
3. Press the CONF button.
A confirmation tone will be heard.
3 party conference is now established.
"CONF" will be displayed.

- You may press the HOLD button instead of the first CONF button.

To terminate conference

Replace the handset or press the SP-PHONE button.

- The other two parties will be directly connected together and can converse with each other. (Intercom calls and intercom to outside are OK, outside to outside is not possible.)

To terminate one caller and talk to the other caller.

- If both the conference parties are on the outside:
Press the CO button to talk to the desired party.

- If both the conference parties are on the extension:

Press the ICM button.

You will be connected to the first participant.

- If the conference parties are on the outside and extension:

To talk to the outside party, press the CO button.

To talk to the extension party, press the ICM button.

To leave the other two parties on hold at the same time.

Press the HOLD button.

- In case the other two parties are on the extension, the other two parties can not be left on hold.

Conditions

- Pressing a CO button which is out of conference, allows you to exit from the conference and to access an outside party and the other parties to be connected together.

If the other parties are outside ones, they are disconnected.

If the other parties are on the outside and extension, they are connected.

- Pressing the ICM button for conference, allows you to exit from the conference and to access an intercom.

Call Waiting

To terminate the original call and talk to the new caller.



WILL HEAR A CALL WAITING TONE

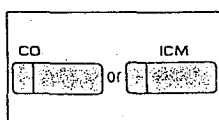

PRESS "CO" OR "ICM" WHOSE INDICATOR IS FLASHING QUICKLY (The original call is now terminated.)



TALK

To place the original call on hold and talk to the new caller.

- If both original call and new call are intercom calls:

(The ICM indicator will change lighting into flashing quickly when new call reaches.)



WILL HEAR A CALL WAITING TONE

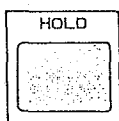

PRESS "HOLD" (The dial tone is not heard.)



CONSULT WITH THE NEW CALLER WHILE THE ORIGINAL CALL IS ON HOLD

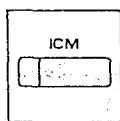

PRESS "ICM" TO TERMINATE THE 2ND CALL AND TO RETURN TO THE ORIGINAL CALL

- If original call is CO call, and new call is CO call or intercom call:

or

If original call is intercom call and new call is CO call:



WILL HEAR A CALL WAITING TONE

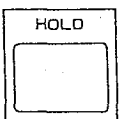

PRESS "HOLD" (The dial tone is heard.)

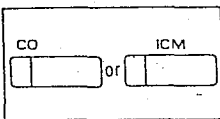

PRESS "CO" OR "ICM" WHOSE INDICATOR IS FLASHING QUICKLY



CONSULT WITH THE NEW CALLER WHILE THE ORIGINAL CALL IS ON HOLD

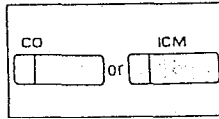

PRESS "CO" or "ICM" WHOSE INDICATOR IS FLASHING SLOWLY TO TERMINATE THE 2ND CALL AND TO RETURN TO THE ORIGINAL CALL

Description

Call waiting tone during a conversation indicates there is a new incoming CO line call or Intercom call.

This feature is required to be set beforehand in the KX-T61610.

For programming, see page 3-28.

Operation

To terminate the original call and talk to the new caller.

1. You will hear a call waiting tone (3 beeps).
2. Press the CO or ICM button whose indicator is flashing quickly. The original call is now terminated.
3. Start talking.

To place the original call on hold and talk to the new caller.

- If both original call and new call are intercom calls:

(The ICM indicator will change lighting into flashing quickly when new call reaches.)

1. You will hear a call waiting tone (3 beeps).
2. Press the HOLD button for placing a conversation on hold.

3. Consult with the new caller.
4. Press the ICM button to terminate the second call and to return to the original call.

- If original call is CO call, and new call is CO call or intercom call:

or

If original call is intercom call and new call is CO call:

1. You will hear a call waiting tone.
2. Press the HOLD button for placing a conversation on hold.
3. Press the CO or ICM button whose indicator is flashing quickly.
4. Consult with the new caller.
5. Press the CO or ICM button whose indicator is flashing slowly to terminate the second call and to return to the original call.

Conditions

- If a call waiting tone is heard and the CO or ICM indicator does not flash, this tone indicates a call waiting tone by special company service.

In this case, see "Call Waiting-Outside Line" on page 4-24.

Call Transfer

To transfer after other extension answers



PRESS
"TRANSFER"

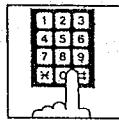

DIAL THE
EXTENSION
NUMBER



ANNOUNCE
AND WAIT
FOR AN
ANSWER



HANG UP OR
PRESS
"SP-PHONE"

To transfer without announcing the other extension



PRESS
"TRANSFER"

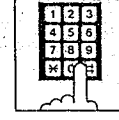

DIAL THE
EXTENSION
NUMBER



HANG UP OR
PRESS
"SP-PHONE"

To Retrieve the Call

If the other extension did not receive the transferred call within 30 seconds after the call has been transferred, the call will return to you. In this case:

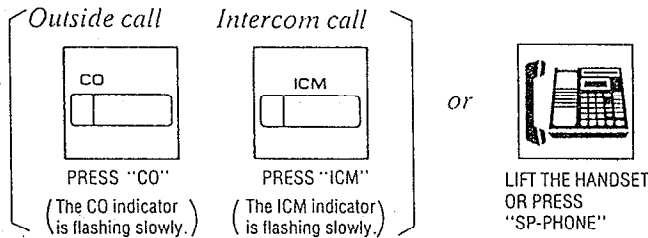

Description

Outside or intercom calls may be transferred to any extension manually.

Operation

1. You are engaged in a call (outside or intercom).
2. Press the TRANSFER button.
3. Dial number of extension (11 through 26) to which the call is transferred.
4. For Unscreened call transfer, replace the handset or press the SP-PHONE button. For Screened call transfer, wait for new party to answer and announce call, then replace the handset or press the SP-PHONE button.

To retrieve the Call

If the other extension did not receive the transferred call within 30 seconds after the call has been transferred, the call will return to you.

In this case:

Press the CO or ICM button whose indicator is flashing slowly or lift the handset.

To change the party to whom a call is transferred before hanging up

Press the CO or ICM button whose indicator is flashing slowly to retrieve the call, then repeat the procedure of Call Transfer.

Conditions

- Upon recall to the transferring extension, if call is not answered in 30 minutes it will be terminated.
- When busy, you may access the other extension by dialing 1. Also you may return to the calling party by pressing the CO or ICM button whose indicator is flashing slowly (green color).
- The time that the call returns to you when the transferred call is not received can be changed 30 seconds into 2 minutes. For changing, see page 3-53.

Call Splitting—Between CO and Intercom

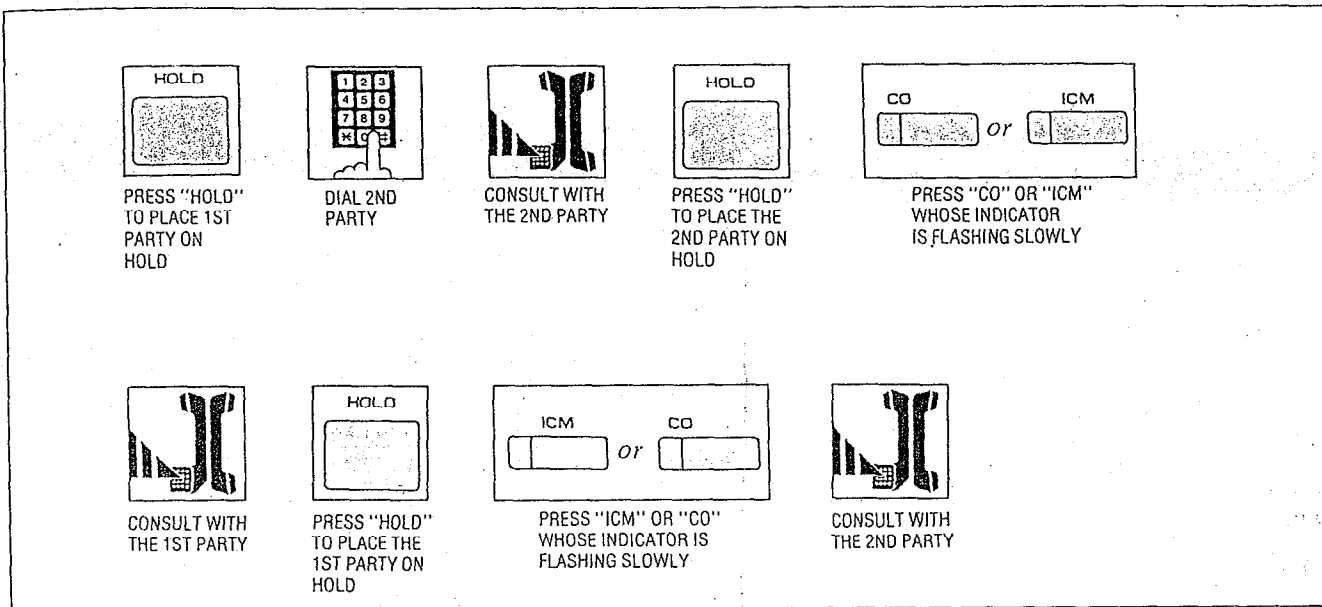

Description

Allows an extension user to alternate between a CO party and an Intercom party.

Operation

1. Press the HOLD button to place the first party on hold.
2. Dial the second party.
3. Consult with the second party.
4. Press the HOLD button to place the second party on hold.
5. Press the CO or ICM button whose indicator is flashing slowly.
6. Consult with the first party.
7. Press the HOLD button to place the first party on hold.

8. Press the ICM or CO button whose indicator is flashing slowly.

9. Consult with the second party.

10. Repeat step 4 to 9.

Conditions

- To release the call splitting mode, press the CO or ICM button without pressing the HOLD button.
Conversation will be terminated and call on hold will be returned to conversation.

Call Splitting—Intercom

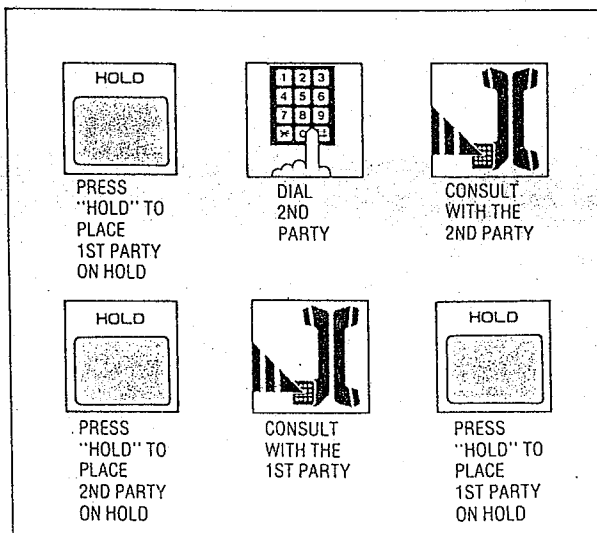

Description

Allows an extension user to alternate between two intercom parties.

Operation

1. Press the **HOLD** button to place the first party on hold.
2. Dial the second party.
3. Consult with the second party.
4. Press the **HOLD** button to place the second party on hold.
5. Consult with the first party.
6. Press the **HOLD** button to place the first party on hold.
7. Repeat step 3 to 6.

Conditions

- To release the call splitting mode, press the **ICM** button instead of the **HOLD** button. Conversation will be terminated and call on hold will be returned to conversation.

Paging

Paging All Extensions

To access



LIFT THE HANDSET OR PRESS "SP-PHONE"

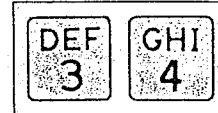

DIAL "34"



CONFIRMATION TONE OF 1 BEEP WILL BE HEARD



PAGE



WAIT FOR AN ANSWER AND TALK

- Page will be heard only from the built-in speaker of **KX-T61630**, **KX-T61620**, **KX-T61650**, **KX-T30830**, **KX-T30820** or **KX-T30850**.



Description

Allows paging to all extensions.

Operation

To access paging:

1. Lift the handset or press the **SP-PHONE** button.
2. Dial (34) and wait for confirmation tone (one beep).
"PAGING (ALL)" will be displayed.
3. Start paging.
4. Wait for an answer and talk.

Conditions

- When an extension is in use, that extension cannot gain access to paging.
- When any extension is using the paging (all extensions, group or external), you cannot access to paging.

Paging Group

To access

For pickup group 1



LIFT THE HANDSET
OR PRESS
"SP-PHONE"

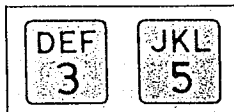

DIAL "35"



CONFIRMATION
TONE



PAGE



WAIT FOR AN
ANSWER
AND TALK

For pickup group 2:

At step 2 above, dial 36 instead of 35.

For pickup group 3:

At step 2 above, dial 37 instead of 35.

For pickup group 4:

At step 2 above, dial 38 instead of 35.

- Page will be heard only from the built-in speaker of KX-T61630, KX-T61620, KX-T61650, KX-T30830, KX-T30820 or KX-T30850.



Description

Allows paging to one of four groups.

Operation

To access paging;

1. Lift the handset or press the SP-PHONE button.
2. Dial (35) for paging the pickup group 1.
Dial (36) for paging the pickup group 2.
Dial (37) for paging the pickup group 3.
Dial (38) for paging the pickup group 4.
 - The confirmation tone (one beep) will be heard.
 - "PAGING (GRP 1)", "PAGING (GRP 2)", "PAGING (GRP 3)" or "PAGING (GRP 4)" will be displayed.
3. Start paging.
4. Wait for an answer and talk.

Conditions

- When an extension is in use, that extension cannot gain access to paging.
- Refer to "Dial Call Pickup Group Assignment" on page 3-33.

Paging—External

To access



LIFT THE HANDSET
OR PRESS
"SP-PHONE"

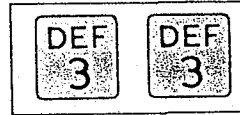

DIAL "33"



CONFIRMATION
TONE



PAGE



WAIT FOR CONFIRMATION
TONE AND TALK

- Page will be heard from external paging equipment.



Description

Allows access to external paging equipment.

Operation

To access external paging;

1. Lift the handset or press the SP-PHONE button.
2. Dial (33) and wait for confirmation tone (one beep).
"EXTERNAL PAGING" will be displayed.
3. Start paging.
When the page is answered, one beep will be heard. Start talking.

Conditions

- If external paging access tone is set to "DISABLE", confirmation tone will not be heard after accessing the external paging.
Refer to "Programmable External Paging Access Tone" on page 3-47.

Paging And Transfer

To transfer a call to the paged person



WHILE HAVING
A CONVERSATION

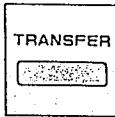

PRESS
"TRANSFER"

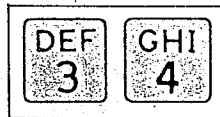

DIAL "34"

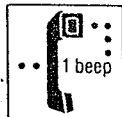

CONFIRMATION
TONE



PAGE

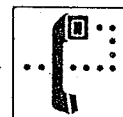

WAIT FOR AN
ANSWER



HANG UP OR
PRESS
"SP-PHONE"

- You may dial 35, 36, 37, 38 or 33 instead of 34.

Operation

To transfer a call to the paged person;

1. You are in conversation.
2. Press the TRANSFER button.
3. Dial (34) for paging all extensions.
Dial (35) for paging group 1.
Dial (36) for paging group 2.
Dial (37) for paging group 3.
Dial (38) for paging group 4.
Dial (33) for paging-external.
 - Wait for confirmation tone.
4. Start paging.
5. Wait for an answer.
6. Hang up or press the SP-PHONE button.

Paging—Answer

To answer



LIFT THE HANDSET
OR PRESS
"SP-PHONE"

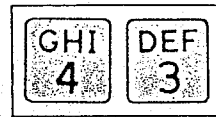

DIAL "43"

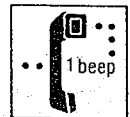

CONFIRMATION
TONE



TALK

Description

A page from the built-in speaker or external paging equipment can be answered from any extension.

Operation

To answer paging;

1. Lift the handset or press the SP-PHONE button.
2. Dial (43) and wait for confirmation tone (one beep).
3. Start talking.

Conditions

- If a call and CO number has been paged and transferred, you may answer by pressing the CO button whose number has been paged and indicator is flashing slowly (red color), instead of dialing 43.

Use of Other Features

Background Music

To enable



LIFT THE HANDSET
OR PRESS
"SP-PHONE"

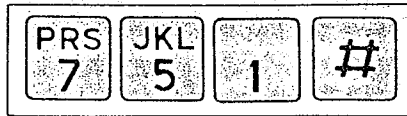

DIAL "751#"



REPLACE THE
HANDSET
OR PRESS
"SP-PHONE"



WILL HEAR
MUSIC

To cancel



LIFT THE HANDSET
OR PRESS
"SP-PHONE"

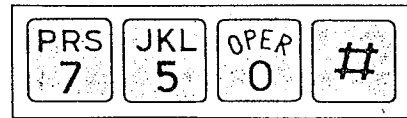

DIAL "750#"



REPLACE THE
HANDSET
OR PRESS
"SP-PHONE"

Description

- Music from an external source (e.g. radio) can be listened to on the built-in speaker of the telephone.

Operation

To enable

1. Lift the handset or press the SP-PHONE button.
2. Dial (751#).
Wait for confirmation tone.
"BGM ON" will be displayed.
3. Replace handset or press the SP-PHONE button.
Music will be heard from the speaker.

To cancel

1. Lift the handset or press the SP-PHONE button.
2. Dial (750#).
Wait for confirmation tone.
"BGM OFF" will be displayed.
3. Place the handset back on the cradle or press the SP-PHONE button.
Music will be stopped.

Conditions

- When listening to the background music, the music will be interrupted by incoming calls, lifting handset or pressing the SP-PHONE button. After completion of the conversation replacing the handset back on the cradle or by pressing of the SP-PHONE button, will resume the background music.

Mute Operation

To enable

Be sure the SP-PHONE indicator is on.

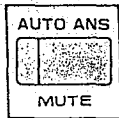

PRESS
"MUTE"

- The MUTE indicator will flash.

To cancel

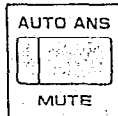

PRESS
AGAIN

Description

Use when you do not want your voice to be heard by the other party.

Operation

To enable

Be sure the SP-PHONE indicator is on.
Press the MUTE button.

- The MUTE indicator will flash.

To cancel

Press the MUTE button again.

- The MUTE indicator will go out.

Conditions

- This feature can be activated in speakerphone mode only.

One Touch Access for System Features

To Program

Set the MEMORY switch of the KX-T61630, KX-T61620, KX-T61650, KX-T30830, KX-T30820 or KX-T30850 to "PROGRAM".

Example:

Paging All Extensions (Dial 34).

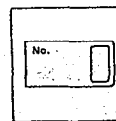

PRESS
"PROGRAMMABLE
FEATURE"

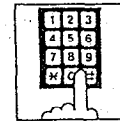

DIAL "34"

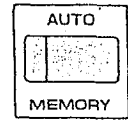

PRESS
"MEMORY"

After programming all the system features, return the MEMORY switch to "SET".

To Access



LIFT THE HANDSET
OR PRESS
"SP-PHONE"

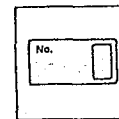

PRESS
"PROGRAMMABLE
FEATURE"

Description

Features that can be accessed by using the dialing button also can be programmed into memory.

(e.g. Paging All Extensions, Background Music.)

Operation

To Program

Set the MEMORY switch of the KX-T61630, KX-T61620, KX-T61650, KX-T30830, KX-T30820 or KX-T30850 to "PROGRAM".

Example:

Paging All Extensions (Dial 34)

1. Press the PROGRAMMABLE FEATURE button.
2. Dial (34).
3. Press the MEMORY button.

- System feature described in the table on page 6-5 can be programmed into memory. After programming all the numbers, return the MEMORY switch to "SET".

To Access

1. Lift the handset or press the "SP-PHONE" button.
2. Press the PROGRAMMABLE FEATURE button.

External Feature Access

Call Waiting—Outside Line

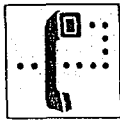

WILL HEAR
A CALL
WAITING
TONE

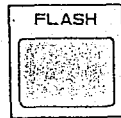

PRESS
"FLASH"



CONSULT WITH
THE NEW CALLER
WHILE THE
ORIGINAL CALL
IS ON HOLD

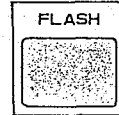

PRESS
"FLASH"



CONSULT WITH
THE ORIGINAL
CALLER WHILE
THE 2ND CALL
IS ON HOLD
(If the calling party on
hold hangs up, the
line is terminated.)

Description

Allows extension user to access features of the central office or host PBX. (example: call waiting feature can be supplied by central office.)

Operation

Call Waiting-Outside Line

1. While having a conversation, another party calls and a call waiting tone is heard.
2. Press the FLASH button.
 - The original call is placed on hold and the new call can be answered.
3. Press the FLASH button again.
 - The original caller can be spoken to again and the new call is placed on hold.
 - If the calling party on hold hangs up, the line is terminated.

Conditions

- The external feature (call waiting) can only be accessed when engaged on an outside call. The above-mentioned example shows you one of the procedures.
- "Flash" can be stored into memory in the same way as "Storage" on page 4-4.
- You may access some features of host PBX using the Flash button. If KX-T61610 is connected to host PBX and flash operation is required, follow the procedure of flash operation which is required in the host PBX.

Account Code

Forced Mode

■ Making a Call



LIFT THE HANDSET
OR PRESS
"SP-PHONE"

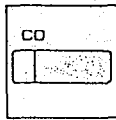

PRESS "CO"

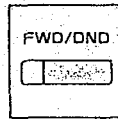

PRESS
"FWD/DND"
"F3"

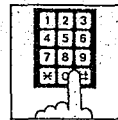

DIAL THE
ACCOUNT
CODE
(Account
code is
4 digits.)

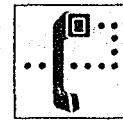

WAIT FOR THE
C.O. DIAL TONE

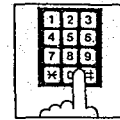

DIAL THE PHONE
NUMBER

■ Receiving a Call

If you want to record a calling party's account code in the SMDR, follow the below-mentioned procedure.

Within 30 seconds of finishing your conversation or while having a conversation,

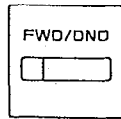

PRESS
"FWD/DND"
"F3"

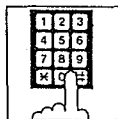

DIAL THE
ACCOUNT
CODE

- Dialing the account code must be done before hanging up.

Option Mode

■ Making or Receiving a Call

If you want to record a calling or called party's account code in the SMDR, follow the below-mentioned procedure.

Within 30 seconds of finishing your conversation or while having a conversation,

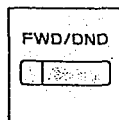

PRESS
"FWD/DND"
"F3"

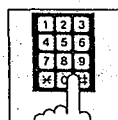

DIAL THE
ACCOUNT
CODE
(Account
code is
4 digits.)

- Dialing the account code must be done before hanging up.

Description

This feature gives each message of the SMDR an account code of the called or calling party.

(Station Message Detail Recording (SMDR) is cost saving feature that records all incoming and outgoing calls through the CO line.)

This feature has two modes "Forced" and "Option".

In the "Forced" mode, the account code must be entered every time the extension user dials.

In the "Option" mode, the account code may be entered when a record of the account code is needed.

When setting to the "Forced" mode, see page 3-34.

The programmable feature (F3 only) button of the KX-T61650 or KX-T30850 can also be used for "Account Code" if programming is done beforehand in the KX-T61610.

For programming, see page 3-54.

Operation

Forced Mode

■ Making a Call

1. Lift the handset or press the SP-PHONE button.
2. Press the CO button.
The FWD/DND Indicator will flash.
3. Press the FWD/DND (or F3) button.
"ENTER ACCNT CODE" will be displayed. The FWD/DND Indicator will light.
Intermittent tone is heard.
4. Dial the account code.
Account code must be 4 digits.
CO dial tone will be heard.
5. Dial the phone number.

- You may dial 9 or 81 through 86 instead of pressing the CO button.

■ Receiving a call

If you want to record a calling party's account code in the SMDR follow the below-mentioned procedure.

Within 30 seconds of finishing your conversation or while having a conversation,

The FWD/DND Indicator will flash.

1. Press the FWD/DND (or F3) button.
"ENTER ACCNT CODE" will be displayed. The FWD/DND Indicator will light.
2. Dial the account code.
Account code must be 4 digits.
 - Dialing the account code must be done before hanging up.

Option Mode



■ Making or Receiving a Call

If you want to record a calling or called party's account code in the SMDR, follow the below-mentioned procedure.

Within 30 seconds of finishing your conversation or while having a conversation,

1. Press the FWD/DND (or F3) button.
"ENTER ACCNT CODE" will be displayed. The FWD/DND Indicator will light.
2. Dial the account code.
Account code must be 4 digits.
 - Dialing the account code must be done before hanging up.

Conditions

- Account code must be required 4 numerical digits except for the  and  buttons.
- If you enter the wrong account code, press the FWD/DND button and enter the correct code.

- If account codes are programmed with telephone numbers for one touch dialing or system speed dialing, you need not to dial an account code when making a call. Program as follows.

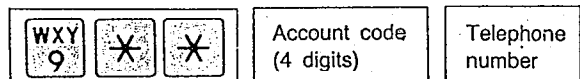

AND OPERATION

DSS Console (KX-T61640)

DSS (Direct Station Select) Button

Inter Office Calling (Intercom)



LIFT THE HANDSET
OR PRESS
"SP-PHONE"

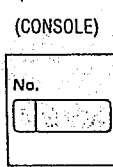

PRESS THE
DSS BUTTON



TALK



HANG UP OR
PRESS
"SP-PHONE"

Programmable Feature Button

Programming

- Be sure the handset is in the cradle and the SP-PHONE button is OFF.
- Set the MEMORY switch of a pair telephone (KX-T61630, KX-T61620, KX-T61650, KX-T30830, KX-T30820 or KX-T30850) to "PROGRAM".

Storage

One Touch Dialing

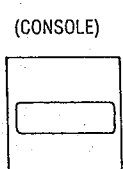

PRESS
"PROGRAMMABLE
FEATURE"

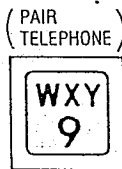

DIAL "9"

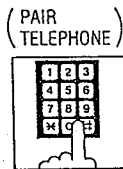

DIAL THE
PHONE
NUMBER

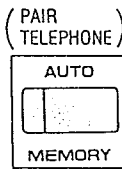

PRESS
"MEMORY"

- You may dial 81 through 86 instead of 9.
 - 9 Each extension can automatically select an idle CO line.
 - 81 through 86 .. Each extension can select a CO line designated.

9 or 81 through 86 must be dialed for storage.

One Touch Access for System Features

Example:

Paging All Extensions (Dial 34).

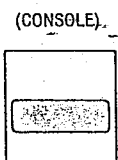

PRESS
"PROGRAMMABLE
FEATURE"

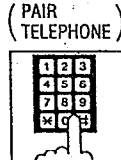

DIAL "34"

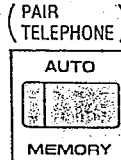

PRESS
"MEMORY"

To Correct an Error while Programming

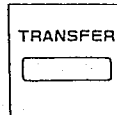

PRESS
"CLEAR (TRANSFER)"
INSTEAD OF
"MEMORY"

- After pressing the CLEAR button, reprogram the correct number.
- The TRANSFER button is used as the CLEAR button.

To Change a Stored Number

Repeat "Storage" left side.

To Erase after Programming

(CONSOLE)

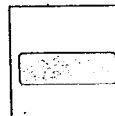

PRESS
"PROGRAMMABLE
FEATURE"

(PAIR TELEPHONE)

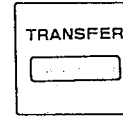

PRESS
"CLEAR
(TRANSFER)"

(PAIR TELEPHONE)

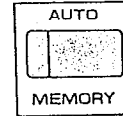

PRESS
"MEMORY"

- The TRANSFER button is used as the CLEAR button.

After programming all the numbers, return the MEMORY switch to "SET".

Dialing



LIFT THE HANDSET
OR PRESS
"SP-PHONE"

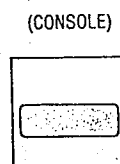

PRESS
"PROGRAMMABLE
FEATURE"

Description

- **DSS (Direct Station Select) Button:**
makes the dialing to the extensions very easy. You can reach the extension party by simply pushing the DSS Button.
- **Programmable Feature Button:**
lets you access various features of KX-T61610 and speed dialing using the CO line in addition to the numbers programmed into the KX-T61610's memory.

Operation

DSS (Direct Station Select) Button

Inter office Calling
(Intercom)

1. Lift the handset or press the SP-PHONE button of pair telephone.
2. Press the DSS button of Console.
3. Start talking.
4. Hang up or press the SP-PHONE button upon completion of the conversation.

Programmable Feature Button

Programming

- Be sure the handset is in the cradle and the SP-PHONE button is OFF.
- Set the MEMORY switch of a pair telephone (KX-T61630, KX-T61620, KX-T61650, KX-T30830, KX-T30820 or KX-T30850) to "PROGRAM".

One Touch Dialing

1. Press a programmable feature button of Console.

2. Enter the line access number.
9: automatic line access number
81: line access number of CO1
⋮
86: line access number of CO6

3. Enter the phone number.
4. Press the MEMORY button.
5. Repeat steps 1 to 4, to program on other programmable feature button.

■ To Confirm a Stored Number

Repeat programming the same number into the same station.

When the MEMORY button is pressed, a beep will be heard.

- two beeps .. storage is correct
 - one beep .. storage is incorrect
- Repeat the procedure of programming.

One Touch Access for System Features

Example:

Paging All Extensions (Dial 34)

1. Press a programmable feature button of Console.
2. Dial (34).
3. Press the MEMORY button of pair telephone.

After programming all the numbers, return the MEMORY switch to "SET".

Dialing

1. Lift the handset or press the SP-PHONE button of pair telephone.
2. Press the programmable feature button of Console.

Conditions

Refer to "One Touch Dialing" page 4-4 and "One Touch Access for System Features" page 4-23.

Pulse/Tone Conversion

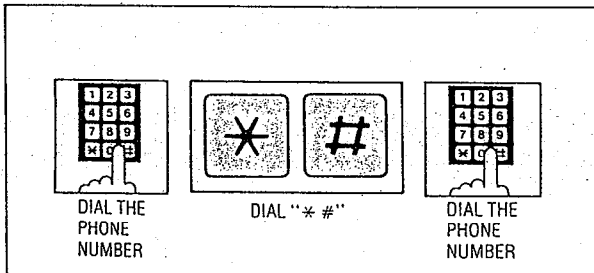

Description

When the dialing mode is required to change a pulse mode to a tone mode in one dialing sequence, this feature is used.

(e.g. computer-accessed long distance service)

Operation

1. Dial the phone number. (pulse mode)
2. Dial (* #).
3. Dial the phone number. (tone mode)

Conditions

- When you dial using this feature, you must use the line set to a pulse mode.
- Phone number after dialing "* # " will change to tone mode.

Example: Computer-accessed long distance service

- Local access telephone number of the alternate long distance service company 765-4321, Authorization no. 0123456, Long distance no. 543-210-9876
- Pulse mode is required by local access telephone number of the alternate long distance service company.
- Service of MCI, SPRINT, METRO or other systems is used.

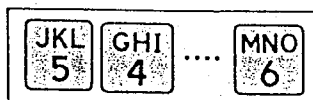
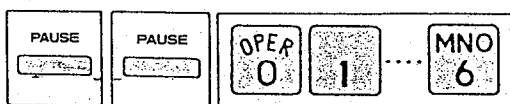
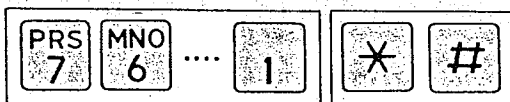

Time Setting

(Extension 11 only)

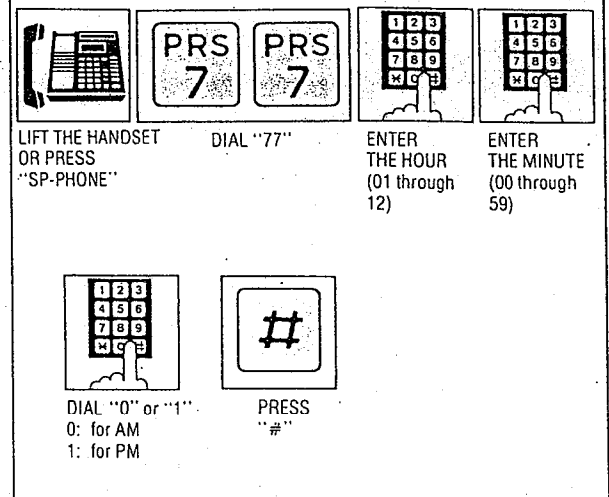

Description

When the present time is out of order, you can adjust by following procedure.

Operation

1. Lift the handset or press the SP-PHONE button on extension 11.
2. Dial (77).
3. Enter the hour with 2 digits. (01 through 12)
4. Enter the minute with 2 digits. (00 through 59)
5. Dial (0) for AM or (1) for PM.
6. Press the # button.
7. Wait for the confirmation tone.

Conditions

- Instantly after pressing the # button, new time counting will start.
- Time setting is done through extension 11 only.

Auto CO Hunting

Setting



LIFT THE HANDSET
OR PRESS
"SP-PHONE"

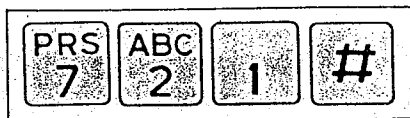

DIAL "721#"



HANG UP OR
PRESS
"SP-PHONE"

To cancel



LIFT THE HANDSET
OR PRESS
"SP-PHONE"

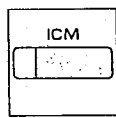

PRESS
"ICM"

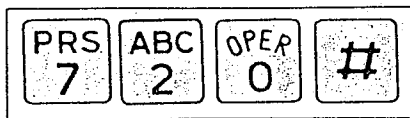

DIAL "720#"



HANG UP OR
PRESS
"SP-PHONE"

Dialing through CO line



LIFT THE HANDSET
OR PRESS
"SP-PHONE"

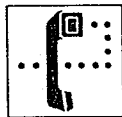

WAIT FOR THE
CO. DIAL TONE

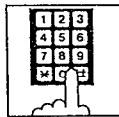

DIAL THE PHONE
NUMBER

Description

Can access any CO line which is not in use directly by picking up the handset or the speakerphone on and tell an extension user which line is accessing by lighting the CO line indicator.

Operation

Setting

1. Lift the handset or press the SP-PHONE button.
2. Dial (721#).
"AUTO CO HUNT ON" will be displayed.
3. Hang up or press the SP-PHONE button.

To cancel

1. Lift the handset or press the SP-PHONE button.
2. Press the ICM button.
3. Dial (720#).
"AUTO CO HUNT OFF" will be displayed.
4. Hang up or press the SP-PHONE button.

Dialing through CO line

1. Lift the handset or press the SP-PHONE button. Dial tone from CO will be heard.
2. Dial the phone number.

- When you access an extension in the Auto CO Hunting, press the ICM button after lifting the handset or pressing the SP-PHONE button.

Conditions

Standard telephone is not available.

Flexible CO button

- Be sure the handset is in the cradle and the SP-PHONE button is off.
- Set the MEMORY switch of the KX-T61630, KX-T61620, KX-T61650, KX-T30830, KX-T30820 or KX-T30850 to "PROGRAM".

Setting

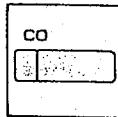

PRESS "CO" WHICH IS CHANGED INTO DIFFERENT CO NUMBER

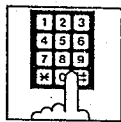

DIAL THE CO NUMBER WHICH IS SET NEWLY (1 through 6)

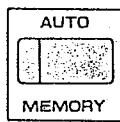

PRESS "MEMORY"

- After programming all CO buttons, return the MEMORY switch to "SET".

Description

Allows each CO button to change into CO number which is different from printed CO number.

Operation

- Be sure the handset is in the cradle and the SP-PHONE button is off.
 - Set the MEMORY switch of the KX-T61630, KX-T61620, KX-T61650, KX-T30830, KX-T30820 or KX-T30850 to "PROGRAM".
1. Press CO button which is changed into different CO number.
 2. Dial the CO number which is set newly (1 through 6).
 3. Press the MEMORY button.
- After programming all CO buttons, return the MEMORY switch to "SET".

Flexible DSS button

- Be sure the handset is in the cradle and the SP-PHONE button is off.
- Set the MEMORY switch of the KX-T30830 to "PROGRAM".

Setting

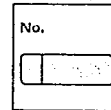

PRESS "DSS" WHICH IS CHANGED INTO DIFFERENT EXTENSION NUMBER

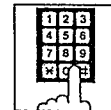

DIAL THE EXTENSION NUMBER WHICH IS SET NEWLY (11 through 26)

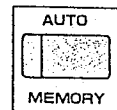

PRESS "MEMORY"

- After programming all DSS buttons, return the MEMORY switch to "SET".

Description

Allows each DSS button to change into extension number which is different from printed extension number.

Operation

- Be sure the handset is in the cradle and the SP-PHONE button is off.
 - Set the MEMORY switch of the KX-T30830 to "PROGRAM".
1. Press DSS button which is changed into different.
 2. Dial the extension number which is set newly (11 through 26).
 3. Press the MEMORY button.
- After programming all DSS buttons, return the MEMORY switch to "SET".

Intercom Alerting Mode

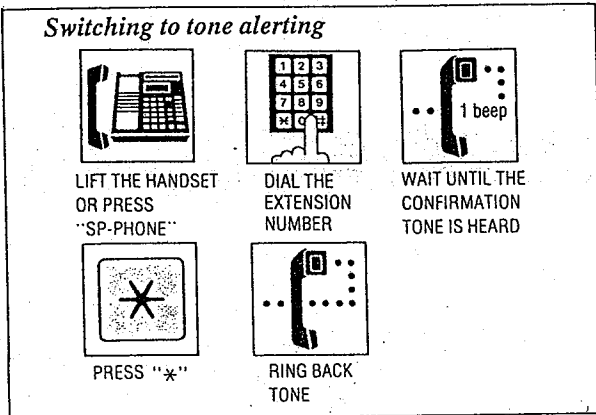

Description

"Voice alerting" (through built-in speaker) that is established at the called party's extension, can be switched to "Tone alerting" (ringing).

This feature is required to be set beforehand in the KX-T61610. For programming, see page 3-31.

Operation

1. Lift the handset or press the SP-PHONE button.
2. Dial the extension number.
3. Wait for a confirmation tone after inter office calling.
4. Press the * button.
The ring back tone will be heard.
Tone Ringer on the called party's extension will be ready to be activated.

Busy Lamp Field

Description

Lamp indicators corresponding to the status of the CO (Central Office) and the ICM (Intercom) buttons.

Explanation

• ICM indicator light

Light	Status
off	idle
on	<ul style="list-style-type: none"> • in use for intercom • in use for CO line to which the CO line number is not assigned.
slow flashing	on hold
flashing in groups of 2	on exclusive hold
quick flashing	<ul style="list-style-type: none"> • receiving an incoming intercom call • receiving an incoming outside call to which the CO line number is not assigned.

• CO indicator light

Light	Status
off	idle
on (green color)	in use
slow flashing (green color)	on hold
flashing in groups of 2 (green color)	on exclusive hold
on (red color)	in use at another extension
slow flashing (red color)	on hold at another extension
quick flashing (red color)	receiving an incoming outside call

Power Failure Transfer

Description

In the event of a power failure each CO will be connected to assigned extension.

- CO 1 is assigned to extension 11.
- CO 2 is assigned to extension 12.
- CO 3 is assigned to extension 13.
- CO 4 is assigned to extension 14.
- CO 5 is assigned to extension 15.
- CO 6 is assigned to extension 16.

Operation

- If extension 11 through 16 is connected with a KX-T61630 or KX-T30830, the Power failure switch on the KX-T61630 or KX-T30830 must be set to the "ON" position.

If dialing cannot be done, set the Dialing mode switch to other position (TONE or PULSE).

Conditions

- During power outage, all features are lost except for incoming and outgoing CO calls from extensions 11 through 16.
- If extension 11 through 16 is connected with a KX-T61620, KX-T61650, KX-T30820 or KX-T30850, disconnect the KX-T61620, KX-T61650, KX-T30820 or KX-T30850 and connect a KX-T61630, KX-T30830 or a standard telephone.
- There is no memory loss except for the camp-on, saved number redial and the last number redial during power failure, memory is protected by 21 day rechargeable battery. Rechargeable battery is good for 5 years.
- The Backup Adaptor (KX-A16) is available as a Backup power supply to the KX-T61610 to operate all the features in the event of power failure. Refer to page 2-15.

Specification of the KX-A16

3 "Sealed lead-acid Batteries" (12 V, 6.5 AH)
Backup duration is greater than 4 hours in average usage.

(one outside call and one intercom call)
simultaneously in continuous operation.)

Duration Time of Call Display

Description

The elapsed time (from dialing to replacing the handset) on originating an outside call will be displayed.

Operation

None

Conditions

- When intercom calls, the duration time of conversation is not displayed.
- "DURATION" will be displayed.
- Refer to "Duration Time Count Start Mode" on page 3-35.

Lockout

Description

If a handset remains off hook or is disconnected at the other end, a reorder tone will be heard. When "Calling Party Control (CPC) Signal" mode is set to "DISABLE", the reorder tone will not be heard. (see page 3-51.)

Operation

None

Conditions

- The party whose handset remains off-hook will hear a reorder tone to indicate that the call is disconnected.

Mixed Station Dialing

Description

Any telephone instrument, whether (KX-T61630, KX-T61620, KX-T61650, KX-T30820, KX-T30830, KX-T30850 for exclusive use), standard rotary phone (10 pps, 20 pps), or standard touch tone phone, may be used as an extension of the KX-T61610.

Operation

None

Station Programming

Dial Call Pickup Deny

Setting



LIFT THE HANDSET
OR PRESS
"SP-PHONE"

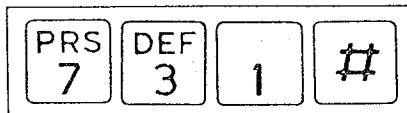

DIAL "731#"



HANG UP OR
PRESS
"SP-PHONE"

To cancel



LIFT THE HANDSET
OR PRESS
"SP-PHONE"

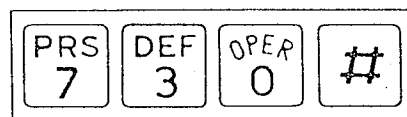

DIAL "730#"

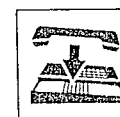

HANG UP OR
PRESS
"SP-PHONE"

Description

Allows you to prohibit any other extension user from answering calls directed to you.

Conditions

While your extension is in the "Dial Call Pickup Deny" mode, you can place or receive outside or intercom calls.

Operation

1. Lift the handset or press the SP-PHONE button.
2. Dial (731#).
Wait for a confirmation tone. "C.PICKUP DENY" will be displayed.
3. Hang up or press the SP-PHONE button.

To cancel,

1. Lift the handset or press the SP-PHONE button.
2. Dial (730#).
Wait for a confirmation tone. "C.PICKUP ALLOW" will be displayed.
3. Hang up or press the SP-PHONE button.

Call Forwarding

Setting:



LIFT THE HANDSET
OR PRESS
"SP-PHONE"

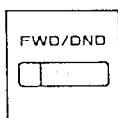

PRESS
"FWD/DND"
"F3"

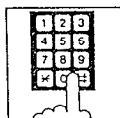

DIAL THE
EXTENSION
NUMBER



HANG UP OR
PRESS
"SP-PHONE"

To cancel:



LIFT THE HANDSET
OR PRESS
"SP-PHONE"

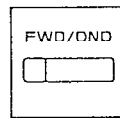

PRESS
"FWD/DND"
"F3"

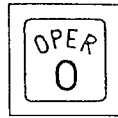

DIAL "0"



HANG UP OR
PRESS
"SP-PHONE"

Description

Outside or intercom calls to your extension can be forwarded to another extension automatically, during your absence.

The programmable feature (F3 only) button of the KX-T61650 or KX-T30850 can also be used for "Call Forwarding" if programming is done beforehand in the KX-T61610.

For programming, see page 3-54.

Operation

To enable

1. Lift the handset or press the SP-PHONE button.
2. Press the FWD/DND (or F3) button.
3. Dial the number of the extension to which the calls are to be forwarded (11 through 26). The indicator light of the FWD/DND button will flash slowly. A confirmation tone will be heard. "FORWARDING EXT" will be displayed.
4. Replace the handset back on the cradle or press the SP-PHONE button.

To cancel

1. Lift the handset or press the SP-PHONE button.
2. Press the FWD/DND (or F3) button.

3. Dial (0).

The indicator light of the FWD/DND button will be off.

Confirmation tone will be heard.

"FWD/DND CANCEL" will be displayed.

4. Replace the handset back on the cradle or press the SP-PHONE button.

Conditions

- Do Not Disturb is cancelled when call forwarding is established.
- If a call is directed to the forwarding extension, the forwarded extension will ring but the originating extension will not ring.
- Recall for camp-on and Hold recall are not forwarded.

- The tone (busy tone or do not disturb tone etc.) the caller receives depends on the condition of the forwarded extension.

do not disturb tone

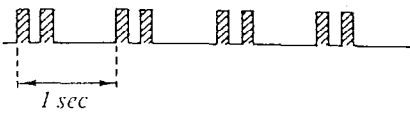

- When an intercom call to the forwarding extension is originated from the forwarded extension, the forwarded extension user will hear a reorder tone.

reorder tone: (two beeps a second)

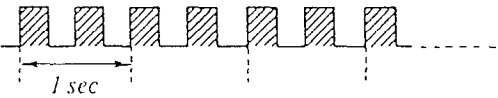

- An extension can not accommodate more than one forwarded extension. At each time of newly setting "Call Forwarding", a destination (forwarded extension code) will be renewed. Old entry will be cancelled.

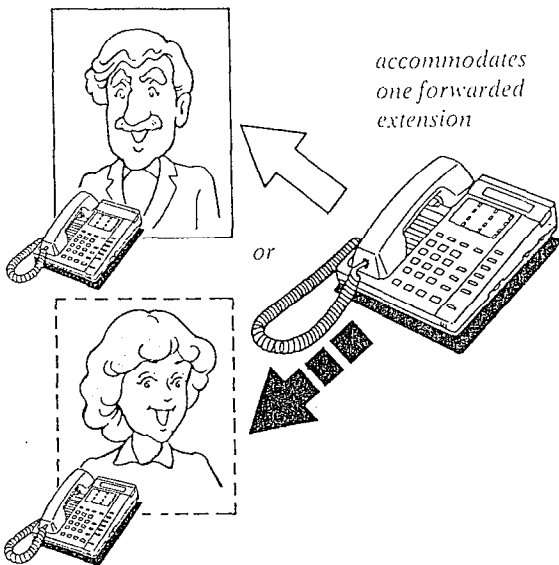

- If extension A is forwarding all calls to extension B and B is forwarding all calls to C, if any extension calls A, they will be connected to C. (If you attempt to forward a call to a forwarding extension, a reorder tone will be heard instead of a confirmation tone to prevent an endless loop.)

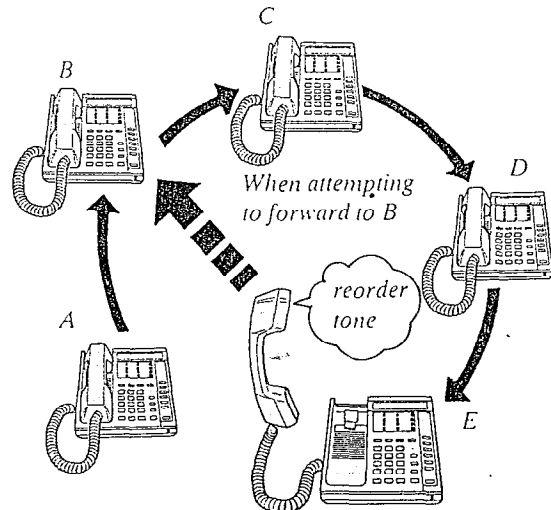
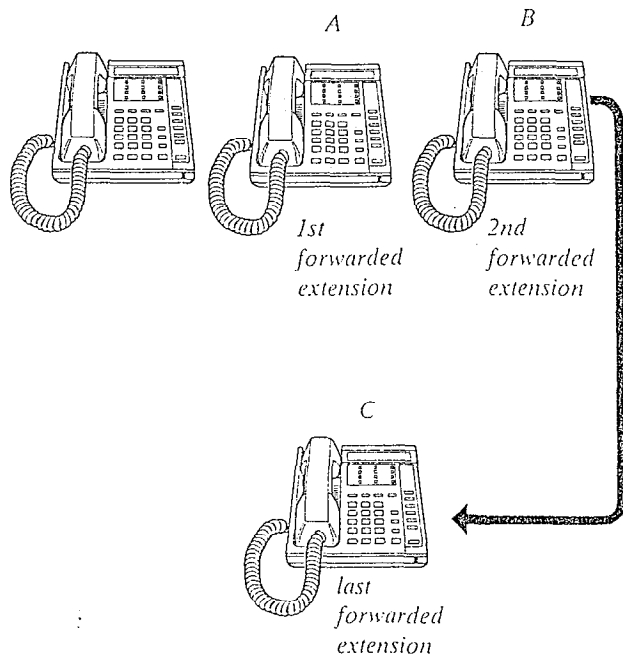

Reorder tone will be produced to prevent an endless loop.

Do not Disturb

Setting



LIFT THE HANDSET
OR PRESS
"SP-PHONE"

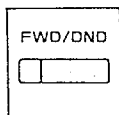

PRESS
"FWD/DND"
"F3"

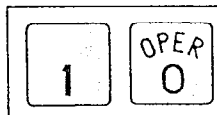

DIAL "10"



HANG UP OR
PRESS
"SP-PHONE"

To cancel



LIFT THE HANDSET
OR PRESS
"SP-PHONE"

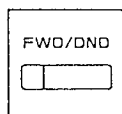

PRESS
"FWD/DND"
"F3"



DIAL "0"



HANG UP OR
PRESS
"SP-PHONE"

Description

Each extension can be individually programmed from receiving outside or intercom calls.

The programmable feature (F3 only) button of the KX-T61650 or KX-T30850 can also be used for "Do Not Disturb" if programming is done beforehand in the KX-T61610.

For programming, see page 3-54.

Conditions

- When "Do not Disturb" is entered, "Call Forwarding" will be cancelled, if entered.
- "Do not Disturb" does not prevent the extension from recalling for on-hold and camp-on.

Operation

1. Lift the handset or press the SP-PHONE button.
2. Press the FWD/DND (or F3) button.
3. For setting, dial (10).

The indicator of FWD/DND button will be lit.
"DO NOT DISTURB" will be displayed.
Wait for a confirmation tone.

For cancellation, dial (0).

The indicator of the FWD/DND button will go out.
"FWD/DND CANCEL" will be displayed.
4. Hang up or press the SP-PHONE button.

Data Line Security

Setting



LIFT THE HANDSET OR PRESS "SP-PHONE"

PRS 7 GHI 4 1 #

DIAL "741 #"

HANG UP OR PRESS "SP-PHONE"

To Cancel



LIFT THE HANDSET OR PRESS "SP-PHONE"

PRS 7 GHI 4 OPER 0 #

DIAL "740 #"

HANG UP OR PRESS "SP-PHONE"

Description

This feature provides security when transmitting data through an extension of KX-T61610.

Operation

1. Lift the handset or press the SP-PHONE button.
2. For setting, dial (741#) and wait for a confirmation tone.
"DATA MODE ON" will be displayed.
For cancellation, dial (740#) and wait for a confirmation tone.
"DATA MODE OFF" will be displayed.
3. Hang up or press the SP-PHONE button.

Conditions

- The parallel connection of the KX-T61630/ KX-T61620/ KX-T61650/ KX-T30830/ KX-T30820/ KX-T30850 and a data terminal equipment is impossible.

Saved Number Redial

Programming

When the called line is busy or while you are speaking on the CO Line;

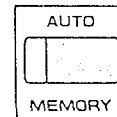

PRESS "AUTO"

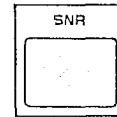

PRESS "SNR"

Dialing



LIFT THE HANDSET OR PRESS "SP-PHONE"

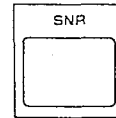

PRESS "SNR"

Description

The desired phone number on an outgoing call to CO line can be stored and then redialed.

Programming

While you are speaking on the CO line or when the called party is busy.

1. Press the AUTO button.
2. Press the SNR button.

- The phone number can not be stored even if you press the AUTO and SNR buttons after you hang up.

Dialing

1. Lift the handset or press the SP-PHONE button.
2. Press the SNR button.

- You may press the CO button to select the CO line directly after lifting the handset or press the SP-PHONE button.

Conditions

- Up to 32 digits can be stored and redialed.
- The KX-T61650 or KX-T30850 will not function for Saved Number Redial.

Flexible Night Service

(Extension 11 only)

To enable night service: (To disable day service)



LIFT THE HANDSET
OR PRESS
"SP-PHONE"

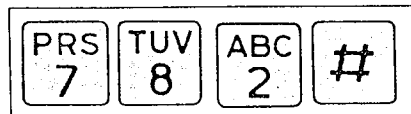

DIAL "782#"



HANG UP OR
PRESS
"SP-PHONE"

To disable night service: (To enable day service)



LIFT THE HANDSET
OR PRESS
"SP-PHONE"

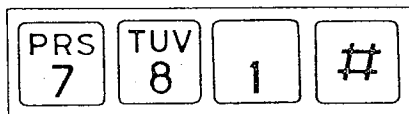

DIAL "781#"



HANG UP OR
PRESS
"SP-PHONE"

Description

Normal system operation is set for day time. Night service allows for the outward dialing and incoming ringing assignments to be rearranged via programming.

Night service is enabled or disabled through extension 11 using this feature, at any time. Without activating this feature, the day/night services are automatically switched at pre-determined time (9:00 AM and 5:00 PM for default time) by the internal clock if the Switching Mode (Day/Night Service) is selected to the "AUTO" mode in the KX-T61610. Refer to "Switching Mode (Day/Night Service)" page 3-12 and "Starting time (Day/Night Service)" page 3-13.

Operation

1. Lift the handset or press the SP-PHONE button of extension 11.
2. Dial (782#) and wait for a confirmation tone.
Night service is enabled.
"NIGHT MODE" will be displayed.
3. To return to day service, dial (781#) and wait for a confirmation tone.
"DAY MODE" will be displayed.
4. Hang up or press the SP-PHONE button.

When the unit is not in use, the present mode selected will be shown by pressing the  button.

Station Program Clear

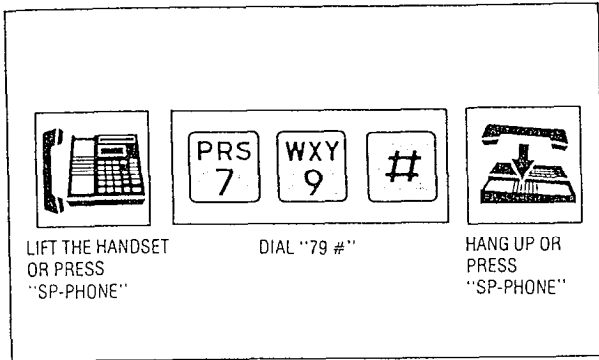

Description

Dialing (79 #) will clear the following station programs on an extension.

Background Music
Call Forwarding
Data Line Security
Dial Call Pickup Deny
Do not Disturb
Auto CO Hunting

Operation

1. Lift the handset or press the SP-PHONE button.
2. Dial (79#) and wait for a confirmation tone. "EXT DATA CLEAR" will be displayed.
3. Hang up or press the SP-PHONE button.

Conditions

- If Auto CO Hunting mode is set, you must push the ICM button and then dial 79 #.

OPERATION FOR A STANDARD TELEPHONE

(rotary and touch tone phones)

To Make Calls

Inter Office Calling (Intercom) (see page 4-1)

Description

Station to station dialing within the KX-T61610 system.

Operation

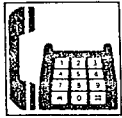

LIFT THE HANDSET

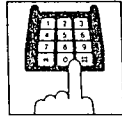

DIAL EXTENSION NUMBER (11 through 26)

Speed Dialing (see page 4-3)

Description

There are 100 memory locations of system speed dialing available.

Operation

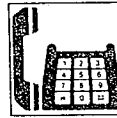

LIFT THE HANDSET

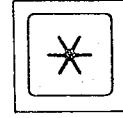

DIAL "*"

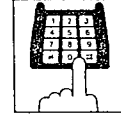

DIAL SPEED ACCESS CODE (00 through 99)

- There is no need to access a CO line.
- A rotary phone will not function for speed dialing.
- Continuous use of speed dialing is impossible.

Outward Dialing (see page 4-2)

Automatic Line Access

Description

Each extension can automatically select an idle CO (Central Office) line within the KX-T61610.

Operation

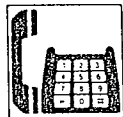

LIFT THE HANDSET

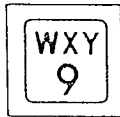

DIAL "9"

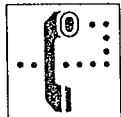

WAIT FOR C. O. DIAL TONE

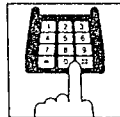

DIAL TELEPHONE NUMBER

Calling Doorphone (see page 4-6)

Description

Up to two doorphones (KX-T30865) can be connected to the KX-T61610.

Operation

Doorphone 1

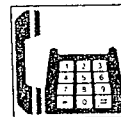

LIFT THE HANDSET

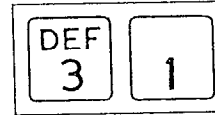

DIAL "31"

Individual Line Access

Description

Any of the 6 CO lines may be selected by dialing the access code(s).

Operation

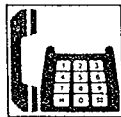

LIFT THE HANDSET



DIAL "8"

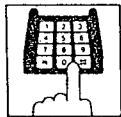

DIAL CO NUMBER (1 through 6)

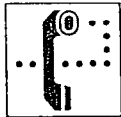

WAIT FOR C. O. DIAL TONE

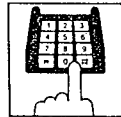

DIAL TELEPHONE NUMBER

Doorphone 2

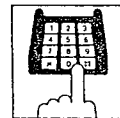

LIFT THE HANDSET

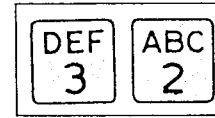

DIAL "32"

When a Line is Busy

Automatic Call Back Busy (Camp-on)

(see page 4-7)

Description

If the intercom extension or outside line you have dialed is busy, you will be automatically called back when the extension or the outside line becomes free using this function.

This feature is also known as camp-on.

Operation

For Outside Calls



DIAL "8"

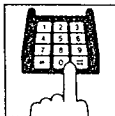

DIAL CO NUMBER
(1 through 6)

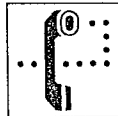

YOU WILL HEAR A BUSY TONE



DIAL "6"



CONFIRMATION TONE



HANG UP

For Intercom Calls

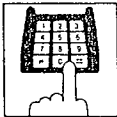

DIAL EXTENSION NUMBER
(11 through 26)

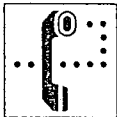

YOU WILL HEAR A BUSY TONE



DIAL "6"

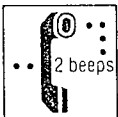

CONFIRMATION TONE



HANG UP

When hearing a ring back

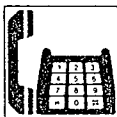

LIFT THE HANDSET

- When using an intercom call, you will hear the ring back tone.
- When using an outside call, you will hear the dial tone from the CO.

- A call back busy cannot be activated on an extension which has a call on hold.

Busy Station Signaling (see page 4-8)

Description

If the extension you have dialed is busy, you can inform that extension that another intercom call is waiting by three beeps. For use of this feature, the other extension is required to be set for this feature beforehand in the KX-T61610.

Operation

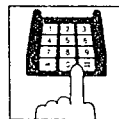

DIAL EXTENSION NUMBER
(11 through 26)

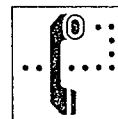

YOU WILL HEAR A BUSY TONE

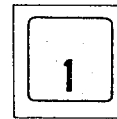

DIAL "1"

- To answer your signal, see "Call Waiting" on page 5-4.

Last Number Redial (see page 4-8)

Description

The last phone number dialed on an outgoing call (CO line) can be redialed.

Operation

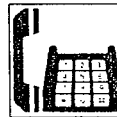

LIFT THE HANDSET

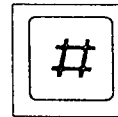

PRESS "#"

- You may dial "80" instead of pressing the "#" button.

FR 154 #

FAVORITE PRESET NUMBER AND OPERATION

To Receive Calls

Answer (see page 4-9)

Operation

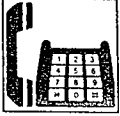

LIFT THE
HANDSET

Dial Call Pickup (see page 4-10)

Description

An extension user can answer any ringing extension within their own pickup group.

Operation

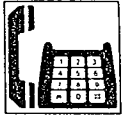

LIFT THE HANDSET



DIAL "4"

Directed Call Pickup (see page 4-10)

Description

An extension may answer an incoming call that is ringing at another extension regardless of their pickup group.

Operation

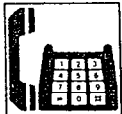

LIFT THE HANDSET



DIAL "4"

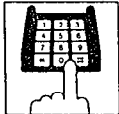

DIAL THE RINGING
EXTENSION NUMBER
(11 through 26)

Call Park Retrieve (see page 4-11)

Description

Allows extension user to retrieve a call (intercom or outside) on hold at any extension.

Operation

To Park a Call

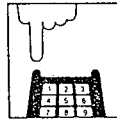

FLASH
HOOKSWITCH

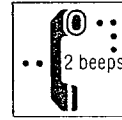

CONFIRMATION
TONE



REPLACE
HANDSET

- Do not depress hookswitch for more than one second, or party will be disconnected.

To Retrieve a Parked Call at Any Other Extension

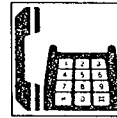

LIFT THE
HANDSET

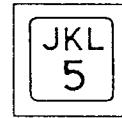

DIAL "5"

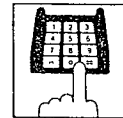

DIAL PARKED
EXTENSION
NUMBER
(11 through 26)

- Even when several outside calls are placed on hold simultaneously, you can retrieve the desired outside call from another extension as following.

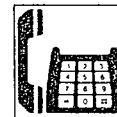

LIFT THE
HANDSET

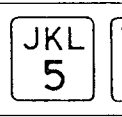

DIAL "58"

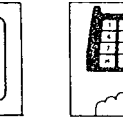

DIAL PARKED
CO NUMBER
(1 through 6)

Doorphone (see page 4-12)

Operation

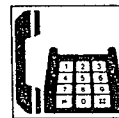

LIFT THE
HANDSET

While Having a Conversation

Call on Hold (see page 4-13)

Description

If you wish to leave your phone unattended but want the caller you are in conversation with to wait, call hold may be used. Intercom and outside calls may be placed on hold.

Operation

To Place a Call on Hold

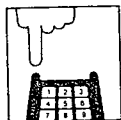

FLASH
HOOKSWITCH

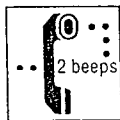

CONFIRMATION
TONE
2 beeps

- Do not depress hookswitch for more than one second, or the party will be disconnected.

To Cancel

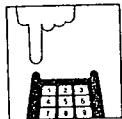

FLASH
HOOKSWITCH

Conference (see page 4-15)

Description

Allows for up to a three party conference. (2-outside/1-inside) (1-outside/2-inside) or (3-inside).

Operation

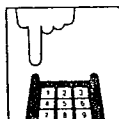

FLASH
HOOKSWITCH
PUTS 1ST PARTY
ON HOLD

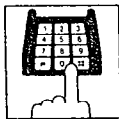

DIAL 2ND
PARTY



CONSULT WITH
2ND PARTY
1ST PARTY
ON HOLD

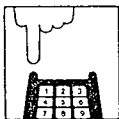

FLASH
HOOKSWITCH

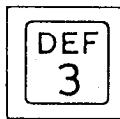

DIAL "3"
(3-party conference)
now established.

To Hold one Caller and Talk to the Other Caller

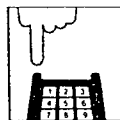

FLASH
HOOKSWITCH



2ND PARTY
ON HOLD
1ST PARTY IN
CONSULTATION

Call Waiting (see page 4-16)

Description

Calls waiting tone during a conversation indicates there is a new incoming CO line call or Intercom call.

This feature is required to be set beforehand in the KX-T61610. For programming, see page 3-28.

Operation



WILL HEAR
CALL WAITING
TONE
3 beeps

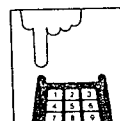

FLASH
HOOKSWITCH
PUTS 1ST PARTY
ON HOLD

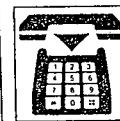

HANG UP

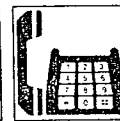

LIFT THE
HANDSET

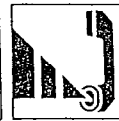

CONSULT NEW
CALLER
1ST PARTY
ON HOLD

- If you use the hold button of a standard telephone, the above-mentioned feature will not function.
- To terminate the original call and talk to the 2nd call, hung up and then lift the handset. (You need not flash the hookswitch.)

Call Splitting (see page 4-18)

Description

Allows station user to alternate between two parties, either intercom or outside.

Operation

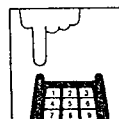

FLASH
HOOKSWITCH

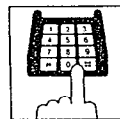

DIAL SECOND
PARTY



CONSULT 2ND PARTY
1ST PARTY ON HOLD

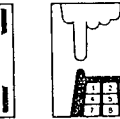

FLASH
HOOKSWITCH



2ND PARTY ON HOLD
1ST PARTY IN
CONSULTATION

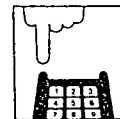

FLASH
HOOKSWITCH



1ST PARTY ON HOLD
2ND PARTY IN
CONSULTATION

AND OPERATION

While Having a Conversation (cont.)

Call Transfer (see page 4-17)

Description

Outside or intercom calls may be transferred to any extension manually.

Operation

To Transfer After Other Extension Answers

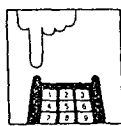

FLASH
HOOKSWITCH

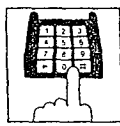

DIAL EXTENSION
NUMBER



ANNOUNCE
AND WAIT
FOR AN
ANSWER



HANG UP

To Transfer without Announcing the Other Extension

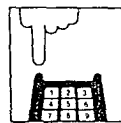

FLASH
HOOKSWITCH

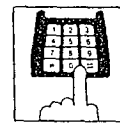

DIAL EXTENSION
NUMBER



HANG UP

To Retrieve the Call

If the other extension did not receive the transferred call within 30 seconds after the call has been transferred, the call will return to you. In this case:



LIFT THE
HANDSET

- The time that the call returns to you when the transferred call is not received can be changed 30 seconds into 2 minutes.

For changing, see page 3-53.

To change the party to whom a call is transferred before hanging up

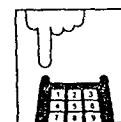

FLASH
HOOKSWITCH
TO RETRIEVE
THE CALL

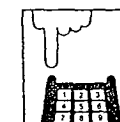

FLASH
HOOKSWITCH

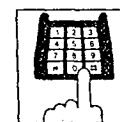

DIAL EXTENSION
NUMBER

Paging

Paging All Extensions (see page 4-19)

Description

Allows paging to all extensions.

Operation

To Access



LIFT THE HANDSET

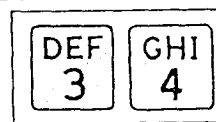

DIAL "34"

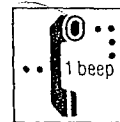

CONFIRMATION
TONE



PAGE



WAIT FOR AN
ANSWER
AND TALK

- Page will be heard only from the built-in speaker of KX-T61630, KX-T61620, KX-T61650, KX-T30830, KX-T30820 or KX-T30850. It will not be heard from the built-in speaker of standard telephone.



Paging (cont.)

Paging Group (see page 4-20)

Description

Allows paging to one of four groups.

Operation

To Access

For Pickup Group 1



LIFT THE HANDSET

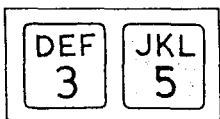

DIAL "35"

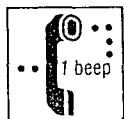

CONFIRMATION TONE



PAGE



WAIT FOR AN ANSWER AND TALK

■ For Pickup Group 2:
At step 2 above, dial 36 instead of 35.

■ For Pickup Group 3:
At step 2 above, dial 37 instead of 35.

■ For Pickup Group 4:
At step 2 above, dial 38 instead of 35.

- Page will be heard only from the built-in speaker of KX-T61630, KX-T61620, KX-T61650, KX-T30830, KX-T30820 or KX-T30850. It will not be heard from the built-in speaker of standard telephone.



Paging And Transfer (see page 4-21)

Operation

To Transfer a Call to the Paged Person

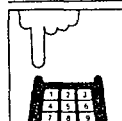

FLASH HOOKSWITCH TO PLACE A CALL ON HOLD

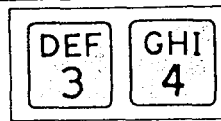

DIAL "34"

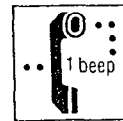

CONFIRMATION TONE



PAGE



WAIT FOR AN ANSWER AND HANG UP

- You may dial 35, 36, 37, 38 or 33 instead of 34.

Paging-Answer (see page 4-21)

Description

A page from the built-in speaker or external paging equipment can be answered from any extension.

Operation

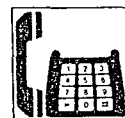

LIFT THE HANDSET

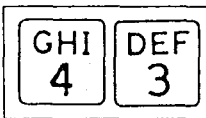

DIAL "43"

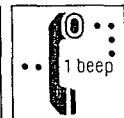

CONFIRMATION TONE



TALK

Paging-External (see page 4-20)

Description

Allows access to external paging equipment.

Operation

To Access



LIFT THE HANDSET

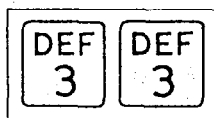

DIAL "33"

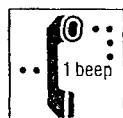

CONFIRMATION TONE



PAGE

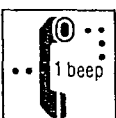

WAIT FOR CONFIRMATION TONE AND TALK OR HANG UP

- Page will be heard from external paging equipment.

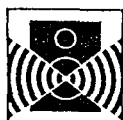

Use of Other Features

External Feature Access (see page 4-24)

Description

Allows extension user to access features of the central office or host PBX. (example: call waiting feature can be supplied by central office.)

- The external feature (call waiting) can only be accessed when engaged on an outside call.
- The following example shows you one of the procedures.

Operation

Call Waiting—Outside Line

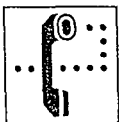

WILL HEAR
A CALL
WAITING
TONE

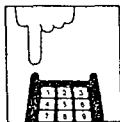

FLASH
HOOKSWITCH

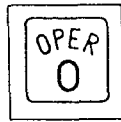

DIAL "0"



CONSULT WITH
THE NEW CALLER
WHILE THE
ORIGINAL CALL
IS ON HOLD

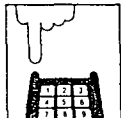

FLASH
HOOKSWITCH

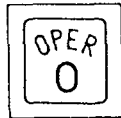

DIAL "0"



CONSULT WITH
THE ORIGINAL CALLER
WHILE THE 2ND CALL
IS ON HOLD

(If the calling party on hold
hangs up, the line is
terminated.)

- Flashing the hookswitch and dialing 0 means flash operation.
- If KX-T61610 is connected to host PBX and flash operation is required, follow the procedure of flash operation which is required for the host PBX.

Intercom Alerting Mode (see page 4-32)

Description

"Voice alerting" (through built-in speaker) that is established at the called party's extension, can be switched to "Tone alerting" (ringing).

- This feature required to be set beforehand in the KX-T61610. For programming, see page 3-31.
- A rotary phone will not function.

Operation

Switching to Tone Alerting

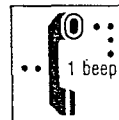

WAIT UNTIL A
CONFIRMATION
TONE IS HEARD

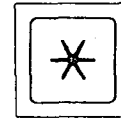

PRESS "*"

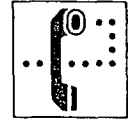

RING BACK
TONE

- You should press "*" button within 10 seconds after the dialing.

Use of Other Features (cont.)

Pulse/Tone Conversion (See page 4-29)

Description

When the dialing mode is required to change from the pulse mode to the tone mode in one dialing sequence, this feature is used. (e.g. computer-accessed long distance service)

Operation

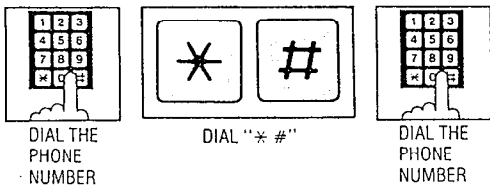

- When you dial using this feature, you must use the line selected in a pulse mode.
- Phone number after dial "*" #" will change to tone mode.
- A rotary phone is not available for the Pulse/Tone Conversion.
- You should press "*" and #" buttons within 5 seconds after the number of the long distance service company.

■ When you use a standard telephone equipped with automatic dialer, be careful the followings:

Example: Computer-accessed long distance service

- Local access telephone number of the alternate long distance service company 765-4321, Authorization no.0123456, Long distance no. 543-210-9876
- Pulse mode is required by local access telephone number of the alternate long distance Service company.
- Service of MCI, SPRINT, METRO or other systems is used.

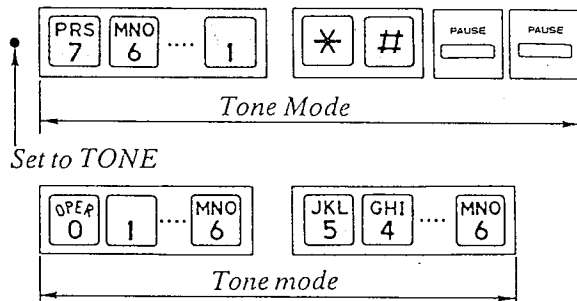

*Standard
410
417 4026
press*

AND OPERATION

Use of Other Features (cont.)

Account Code (see page 4-25)

Description

This feature gives each message of the SMDR an account code of the called or calling party.

(Station Message Detail Recording (SMDR) is cost saving feature that as records all incoming and outgoing calls through the CO line.)

This feature has two modes "Forced" and "Option". In the "Forced" mode, the account code must be entered every time the extension user dials. In the "Option" mode, the account code may be entered when a record of the account code is needed. When setting to the "Forced" mode, see page 3-34.

Operation

Forced Mode

■ Making a Call

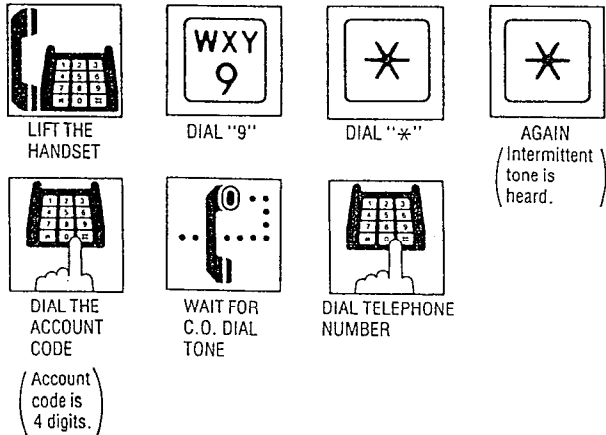

■ Receiving a Call

If you want to record a calling party's account code in a SMDR, follow the below-mentioned procedure.

Within 30 seconds after calling party hangs up,

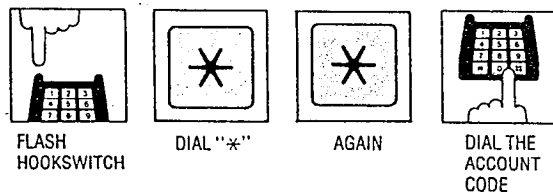

- Dialing the account code must be done before hanging up.

Option Mode

■ Making or Receiving a Call

If you want to record a calling or called party's account code in a SMDR, follow the below-mentioned procedure.

Within 30 seconds after calling or called party hangs up,

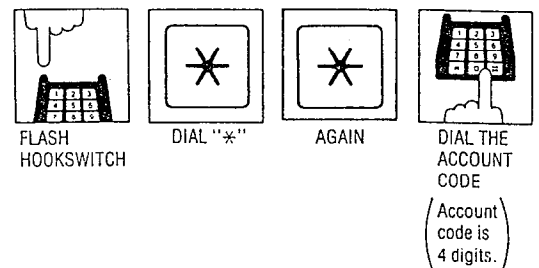

- Dialing the account code must be done before hanging up.

- You may dial 49 instead of pressing the * * button.
- You may dial 81 through 86 instead of dialing 9.
- Account code must be 4 numerical digits except for the # and * buttons.
- If you enter a wrong account code, press the * * button and enter a correct code.

Station Programming

■ You may dial "0" instead of pressing the "#" button.

Call Forwarding (see page 4-35)

Description

All outside or intercom calls to your extension can be forwarded to another extension automatically during your absence.

Operation

Setting

The diagram shows the steps for setting call forwarding:

- LIFT THE HANDSET: An icon of a telephone handset being lifted.
- DIAL "71": A sequence of three boxes containing "PRS", "7", and "1".
- DIAL THE EXTENSION NUMBER: An icon of a hand pressing a button on a telephone keypad.
- DIAL "#": A box containing the hash symbol "#".
- HANG UP: An icon of a telephone handset being placed back on its cradle.

To Cancel

The diagram shows the steps to cancel call forwarding:

- LIFT THE HANDSET: An icon of a telephone handset being lifted.
- DIAL "70#": A sequence of three boxes containing "PRS", "7", and "#".
- HANG UP: An icon of a telephone handset being placed back on its cradle.

Dial Call Pickup Deny (see page 4-34)

Description

Allows you to prohibit any other extension user from answering calls directed to you.

Operation

Setting

The diagram shows the steps for setting dial call pickup deny:

- LIFT THE HANDSET: An icon of a telephone handset being lifted.
- DIAL "731#": A sequence of four boxes containing "PRS", "7", "DEF", "3", "1", and "#".
- HANG UP: An icon of a telephone handset being placed back on its cradle.

To Cancel

The diagram shows the steps to cancel dial call pickup deny:

- LIFT THE HANDSET: An icon of a telephone handset being lifted.
- DIAL "730#": A sequence of four boxes containing "PRS", "7", "DEF", "3", "OPEP", "0", and "#".

Do not Disturb (see page 4-37)

Description

Each extension can be individually programmed from receiving outside or intercom calls.

Operation

Setting

The diagram shows the steps for setting Do not Disturb:

- LIFT THE HANDSET: An icon of a telephone handset being lifted.
- "7110#": A sequence of five boxes containing "PRS", "7", "1", "1", "OPEP", "0", and "#".
- HANG UP: An icon of a telephone handset being placed back on its cradle.

To Cancel

The diagram shows the steps to cancel Do not Disturb:

- LIFT THE HANDSET: An icon of a telephone handset being lifted.
- DIAL "70#": A sequence of three boxes containing "PRS", "7", "OPEP", "0", and "#".
- HANG UP: An icon of a telephone handset being placed back on its cradle.

AND OPERATION

Station Programming (cont.)

Data Line Security (see page 4-38)

Description

This feature provides security when transmitting data through an extension of the KX-T61610. Call waiting or hold time reminder tone from KX-T61610 are prohibited in this mode.

Operation

Setting

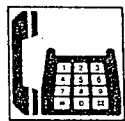

LIFT THE HANDSET

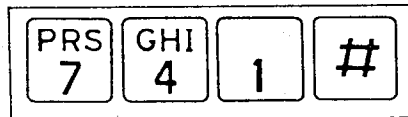

DIAL "741#"

To cancel

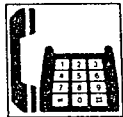

LIFT THE HANDSET

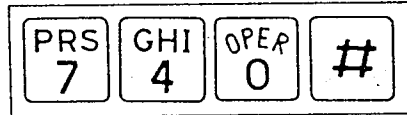

DIAL "740#"

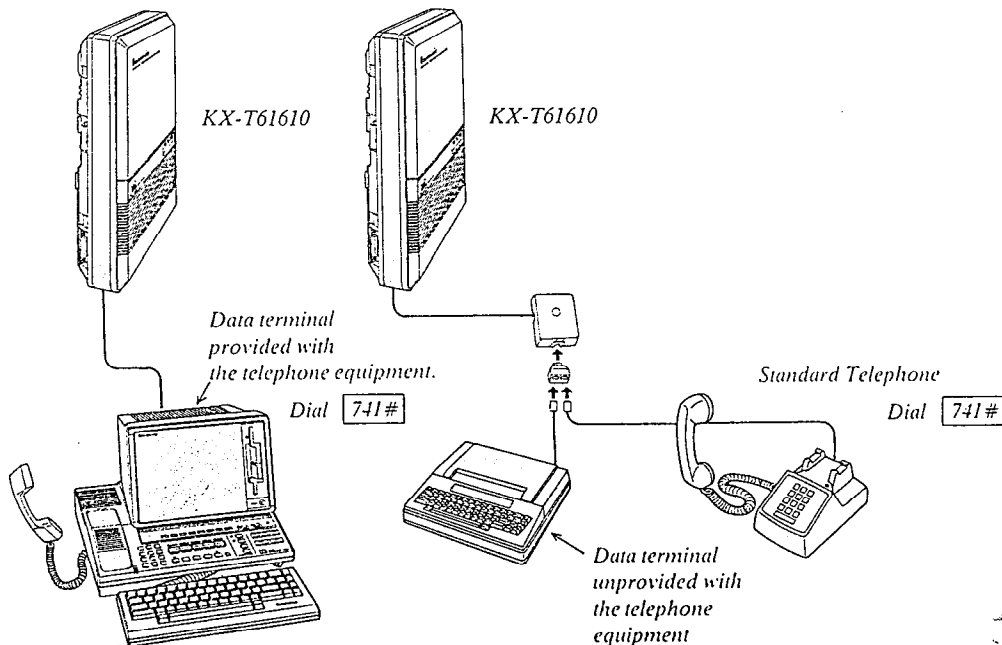

- This mode cannot prevent external call waiting tone from coming into KX-T61610 system. We recommend that this mode is established on a line which has no special telephone company services.

Station Program Clear (see page 4-40)

Description

Dialing (79 #) will clear the following station programs on an extension.

Call Forwarding
Data Line Security
Dial Call Pickup Deny
Do not Disturb
Pickup Dial (enable mode)

Operation

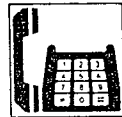

LIFT THE HANDSET

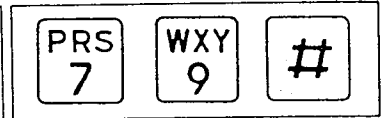

DIAL "79#"



HANG UP

Pickup Dial

Description

Picking up the handset automatically dials a programmed phone number.

To Dial



PICKUP HANDSET
FOR 4-SECONDS

If the "Pickup Dial" feature does not work, hang up for over 1 second, and lift the handset again.

Operation

To Program

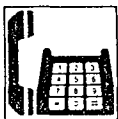

LIFT THE
HANDSET



DIAL "762"

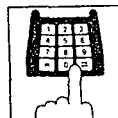

DIAL EXTENSION
NUMBER

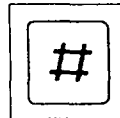

DIAL (#)

- You may dial CO number (9 or 81 through 86) instead of extension number.

- A rotary phone is not available for Pickup Dial.
- Dialing (speed dialing and manual dialing) is possible within 3 seconds.
- When you program an outside dialing, enter line access number, [*][*], account code, and then the desired number.
- The pickup dial will not be activated by picking up handset during a hold or when receiving a call.
- You can not dial "0" instead of pressing the "#" button.

To Enable or Disable

To enable pickup dial

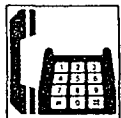

LIFT THE
HANDSET

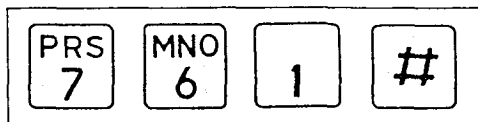

DIAL "761#"

To disable pickup dial

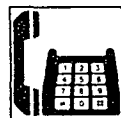

LIFT THE
HANDSET

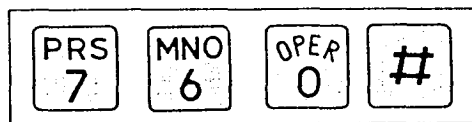

DIAL "760#"

TROUBLESHOOTING

During Installation

PROBLEM	PROBABLE CAUSE	POSSIBLE SOLUTION
<i>Extension does not operate.</i>	<p><i>Bad connection between the system and extension</i></p> <p><i>The system program switch of the KX-T61610 is set to PROGRAM.</i></p> <p><i>A telephone with an A-A1 relay is connected.</i></p> <p><i>Bad extension</i></p>	<p><i>Take that extension and plug it into the same extension port using a short telephone cord. If telephone does not work, connection between the system and the extension must be repaired.</i></p> <p><i>Set to SET except when programming.</i></p> <p><i>Use a 2 wires cord.</i></p> <p><i>Set the A-A1 relay switch of the telephone to OUT or OFF.</i></p> <p><i>Take that extension and plug it into another extension port that is working. If the telephone does not work, replace the phone.</i></p>
<i>Improper reset operation</i>		<i>Press the Reset Button.</i>
<i>Call is disconnected during connection operation.</i>	<i>Instantaneous drop of DC voltage from Central Office (or host PBX) when in operation (connection between C.O. and system.)</i>	<p><i>Program for a no CPC signal (CPC means Calling Party Control)</i></p> <p><i>Set the calling party control signal to "DISABLE".</i></p> <p><i>Refer to page 3-51.</i></p>
<i>Noise in external paging</i>	<i>Induced noise on the wire between the System and the Amplifier.</i>	<p><i>Use a shielded cable as the connection wire between the System and Amplifier.</i></p> <p><i>A short shielded cable is recommended.</i></p>
<i>Volume distortion from external music source</i>	<i>Excessive input level from external music source</i>	<i>Decrease the Output level of the external music source by using the Volume Control on the music source.</i>
<i>Speed dialing or One Touch Dialing does not function.</i>	<i>Bad programming</i>	<i>Enter the line access code (9 or 81 through 86) into programming.</i>
<i>A dial tone (short tone continuously) was heard and telephone line hung up at once when accessing an outside during the speakerphone mode.</i>	<i>The host PBX may have caused the line to hang up when the KX-T61610 was connected to it.</i>	<i>Use the handset instead of the speakerphone.</i>

During Connection

1. Connection between the Central Office and the KX-T61610

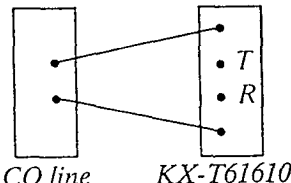
PROBLEM	CAUSE	SOLUTION
Cannot make or receive calls on the CO lines.	CO lines are connected to the H/L. 	Reconnect the CO lines to the T/R of the telephone jack using 2-conductor wiring.

2. Connection between the KX-T61610 and the extensions (KX-T61630, KX-T61620, KX-T30820 and KX-T30830)

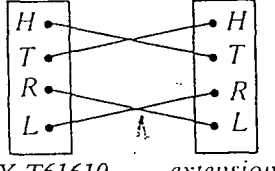
PROBLEM	CAUSE	SOLUTION
Cannot make calls when the SP-Phone button on the KX-T61620 (and KX-T61630, KX-T30820, KX-T30830) is pressed. The SP-Phone indicator does not light.	The T/R is connected to the H/L. 	Use the correct cord (inner 2 wires are for T/R and the outer 2 wires are for H/L).

3. Connection between the KX-T61610 and a standard telephone (with no polarity)

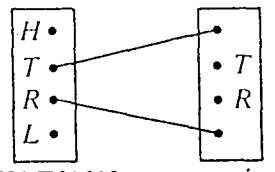
PROBLEM	CAUSE	SOLUTION
When the handset is lifted, nothing is heard.	The T/R is connected to the H/L. 	Use the correct cord (inner 2 wires are for T/R). *If a telephone equipped with an A-A1 relay is connected to the KX-T61610, set the A-A1 relay switch of the telephone to OFF.

4. Connection between the KX-T61610 and a standard telephone that is polarity sensitive

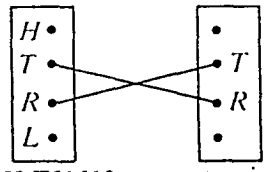
PROBLEM	CAUSE	SOLUTION
Dial tone cannot be heard when the handset is lifted.	The "T" is connected to the "R". 	Reverse the connections of the T/R.

During Operation

PROBLEM	PROBABLE CAUSE	POSSIBLE SOLUTION
Extension does not operate.	The Power failure switch of the KX-T61630 or KX-T30830 is set to ON.	Set the Power failure switch to OFF.
When using the speakerphone mode, nothing is heard.	The HANDSET/ HEADSET selector of the KX-T61630 or KX-T30830 is set to the "HEADSET" position.	When the headset is not used, set the HANDSET/ HEADSET selector to the "HANDSET" position.
The unit does not ring.	Ringer Volume Selector is set to "OFF".	Set to "HIGH" or "LOW".
During a power interruption, extensions 11 through 26 do not operate.	<ul style="list-style-type: none"> • The Power failure switch of the KX-T61630 or KX-T30830 is set to OFF. • The dialing mode (tone or pulse) is improper. • KX-T61620, KX-T61650, KX-T30820 or KX-T30850 is connected. 	<ul style="list-style-type: none"> • Set the Power failure switch to ON. • Set the Tone/Pulse switch to the other position. • Disconnect KX-T61620, KX-T61650, KX-T30820 or KX-T30850 and connect the KX-T61630, KX-T30830 or a standard telephone.

Reset Button

If the system is not operating properly, use the Reset Button.

- Before using the Reset Button, try the system feature again which does not work several times to confirm there definitely is a problem.
- Pressing the Reset button will cause the followings.
 1. Camp-on to be cleared.
 2. Last number redial to be cleared.
 3. Saved number redial to be cleared.
 4. Calls on hold are terminated.
 5. Calls on exclusive hold are terminated.
 6. Calls in progress are terminated.
 Data that is stored in memory other than above mentioned will not be cleared by use of the Reset Button.

Note

If the system does not operate properly, push the Reset Button.

If there still is no difference, switch the power off and on again after 5 minutes. If the system still does not work, switch the power off.

The following extensions will be directly connected to each of the central office lines (C.O.).

- Extension 11...C.O.1
- Extension 12...C.O.2
- Extension 13...C.O.3
- Extension 14...C.O.4
- Extension 15...C.O.5
- Extension 16...C.O.6

If the KX-A16 is connected to the system, switch off the power of the KX-A16.

DTMF Receiver Check

To set

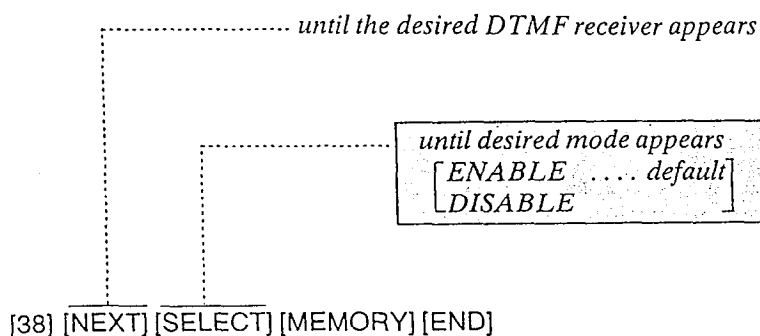

To confirm

Dial any extension (e.g....12) and listen for that extension to ring.

Description

DTMF (Dual Tone Multi Frequency) Receiver enables tone telephones to dial within the system.

To check the DTMF Receivers, activate the DTMF Receivers one at a time and confirm if the receiver can receive tone signals.

Operation at Extension 11

To Remove DTMF Receiver 2:

1. Set the System Program Switch to the PROGRAM position.
2. Dial (38) to enter the DTMF mode.
"DTMF RECVER SEL" will be displayed.
3. Press the NEXT button, twice.
"DTMF 1: ENABLE" and then
"DTMF 2: ENABLE" will be displayed.
4. Press the SELECT button to change to DISABLE.
"DTMF 2: DISABLE" will be displayed.
5. Press the MEMORY button.
6. Press the END button to return to the initial program mode.
7. Set the System Program Switch to the SET position.

Confirmation of DTMF Receiver 1:

1. Set the DIALING MODE (located on the rear of KX-T61630) switch to the TONE position.
2. Set the POWER FAILURE (located on the rear of KX-T61630) switch to the ON position.
3. Dial the extension number (e.g....12).
4. If DTMF Receiver is bad, do the following procedure for removing the DTMF Receiver after the next step on this section.
5. Set the POWER FAILURE Switch to the OFF position.

To check DTMF Receiver 2, remove DTMF Receiver 1 and confirm that DTMF Receiver 2 is good by the procedures of "To Remove DTMF Receiver 1" and "Confirmation of DTMF Receiver 2".

Conditions

- "DISABLE" can not be established on both DTMF Receivers 1 and 2, at the same time.

Table of System Features

The following system features can be programmed into memory.

Dial Plan Code	System Features
Extension no. (11 through 26)	Individual Inter Office Calling
DEF 3 1 or DEF 3 ABC 2	Calling Doorphone 1 or Doorphone 2
DEF 3 DEF 3	Paging—External
DEF 3 GHI 4	Paging All Extensions
DEF 3 JKL 5, DEF 3 MNO 6, DEF 3 PRS 7 or DEF 3 TUV 8	Paging Group 1, 2, 3 or 4
GHI 4 OVEA 0	Dial Call Pickup
GHI 4 Extension no. (11 through 26)	Directed Call Pickup
GHI 4 DEF 3	Paging Answer
JKL 5 Extension no. (11 through 26) OR JKL 5 TUV 8 CO no. (1 through 6)	Call Park Retrieve
MNO 6	Camp-on
PRS 7 OVEA 0 #	Cancelling Call Forwarding or Do Not Disturb
PRS 7 1 Extension no. (11 through 26) #	Call Forwarding
PRS 7 1 1 OVEA 0 #	Do Not Disturb
PRS 7 ABC 2 1 #	Auto CO Hunting
PRS 7 ABC 2 OVEA 0 #	Cancelling Auto CO Hunting
PRS 7 DEF 3 OVEA 0 #	Cancelling Dial Call Pickup Deny
PRS 7 DEF 3 1 #	Dial Call Pickup Deny
PRS 7 JKL 5 OVEA 0 #	Cancelling Background Music
PRS 7 JKL 5 1 #	Background Music
PRS 7 TUV 8 1 #	Flexible Night Service—Day Mode
PRS 7 TUV 8 ABC 2 #	Flexible Night Service—Night Mode

LIST OF TONES

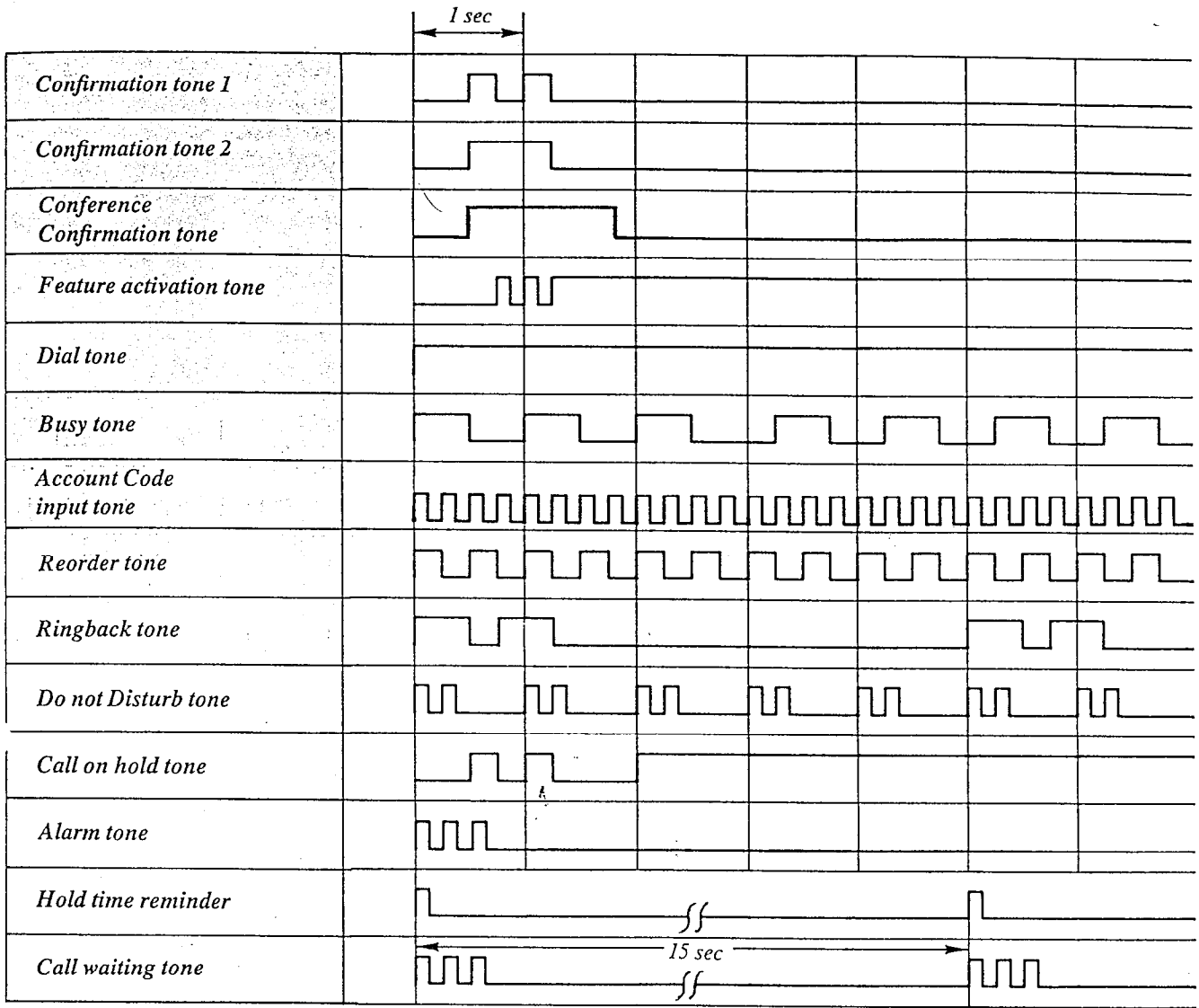

LIST OF RING TONES

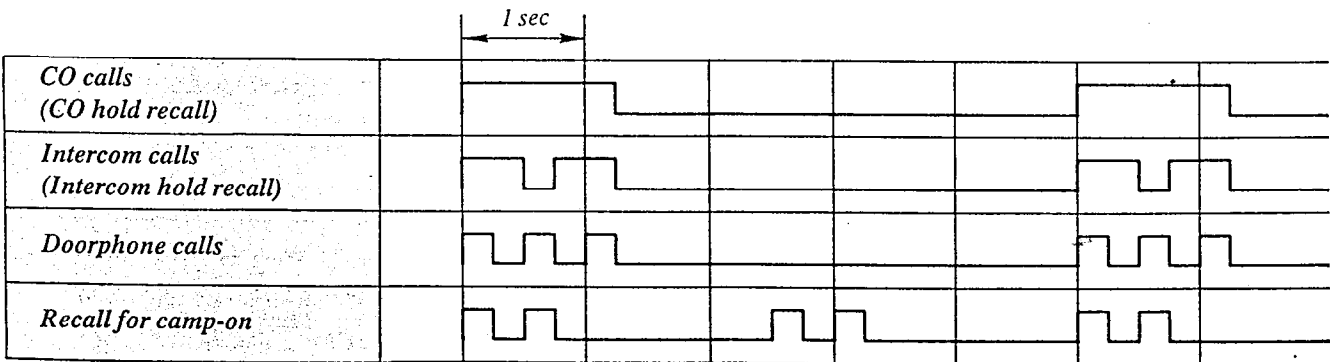

SPECIFICATION

General Description

- | | | | |
|--|--|--|--------------|
| 1. Capacity | Outsides (CO) | 6 | |
| | Stations | 16 | |
| 2. Control Method | Stored Program CPU: 8 bits CPU, 4 bits CPU
Control ROM: 64 KB, Control RAM: 16 KB | | |
| 3. Switching | Space Division CMOS Crosspoint Switch | | |
| 4. Power Supplies | Primary | AC 120 V 60 Hz | |
| | Secondary | Station Supply Volt: -26 V,
Circuit Volt: +5 V, ±7 V, ±15 V, -26 V | |
| | Power Failure | <ul style="list-style-type: none"> • 6 outsides assigned to stations (1 through 6)...power failure transfer • System operation for 4 hours by optional Backup Adaptor. | |
| 5. Dialing | Outward | Dial Pulse | 10PPS |
| | | Tone Dial | |
| | Internal | Dial Pulse | 10PPS, 20PPS |
| | | Tone Dial | |
| | Mode Conversion | DP-DTMF, DTMF-DP | |
| 6. Intercom paths | 4 | | |
| 7. Connector | Outsides (CO) | Modular Jack (RJ-11) | |
| | Station | Modular Jack | |
| | Paging Output | Pin Jack (RCA JACK) | |
| | External Music Input | two-conductors Jack (MINI JACK 3/64 inch diameter) | |
| 8. EXT Connection | Cable | 1 pair wire (Standard Telephone) | |
| | | 2 pair wire (KX-T61630/KX-T61620/KX-T61650/
KX-T30830/KX-T30820/KX-T30850) | |
| | | RS-232C | |
| 9. SMDR
(Station Message)
(Detail Recording) | Interface | Printer, Data Terminal | |
| | Output Equipment | Date, Time, Ext. Number, CO Number,
Calling Number, Calling Time, Account
Code | |
| | Detail Recording | | |

Characteristics

- | | | |
|--|---|------------------------|
| 1. Station Loop Limit | KX-T61630/KX-T61620/KX-T61650/
KX-T30830/KX-T30820/KX-T30850 | 40 ohms |
| | Standard Telephone | 600 ohms including set |
| | Doorphone | 20 ohms |
| 2. Minimum Leak Resistance | 15,000 ohms | |
| 3. Maximum Number of Station
Instruments per Line | 1 (KX-T61630, KX-T61620, KX-T61650, KX-T30830, KX-T30820 or
KX-T30850)
or
6/Ringing group (Standard telephone)
Ringing group (4 groups) | |

Ext. 11, 15, 19, 23

Ext. 12, 16, 20, 24

Ext. 13, 17, 21, 25

Ext. 14, 18, 22, 26

- | | | | |
|----------------------------------|--|--|--|
| 4. Ring Voltage | 90 Vrms at 20 Hz depends on Ringing Load | | |
| 5. Primary Power | 120 Vac, 60 Hz, 0.4 A maximum | | |
| 6. Central Office Loop Limit | 1600 ohms maximum | | |
| 7. Environmental Requirements | 0-40°C, 10%-90% | | |
| 8. Hookswitch Flash Timing Range | 204-1000 msec | | |

TELEPHONE COMPANY and F.C.C. REQUIREMENTS AND RESPONSIBILITIES

In compliance with the requirements of Part 68 of the F.C.C. Rules and Regulations for connection of terminal system (this device is classified as terminal system) to the telephone network and for your convenience, the following information is presented:

1. Notification to the Telephone Company

Customers connecting terminal equipment to the telephone network shall, upon request of the Telephone Company, inform the Telephone Company of the particular line(s) to which such connection is made, the F.C.C. registration number and (see label on bottom of unit.) ringer equivalence number of the registered terminal equipment.

The REN is useful to determine the quantity of devices you may connect to your telephone line and still have all of those devices ring when your telephone number is called. In most, but not all areas, the sum of the REN's of all devices connected to one line should not exceed five (5.0). To be certain of the number of devices you may connect to your line, as determined by the REN, you should contact your local telephone company to determine the maximum REN for your calling area.

2. Direct connection to A Party-line^A or Coin-operated Telephone Line is Prohibited

3. Incidence of Harm to The Telephone lines

Should Terminal Equipment cause harm to the Telephone Network, the Telephone Company shall, where practical, notify the customer that temporary discontinuance of service may be required. However, where prior notice is not practical, the Telephone Company may temporarily discontinue service forthwith, if such action is reasonable in the circumstances. In case of such unnotified temporary discontinuance of service, the Telephone Company shall:

- (a) Promptly notify the customer of such temporary discontinuance of service.
- (b) Afford the customer the opportunity to correct the situation which gave rise to the temporary discontinuance.
- (c) Inform the customer of the right to bring a complaint to the Commission pursuant to the procedures set out in Subpart E of Part 68 of FCC Telephone Equipment Rules.

4. Compatibility of The Telephone Network and Terminal Equipment

(a) Availability of telephone interface information.

Technical information concerning interface parameters and specifications not specified in FCC Rules, including the number of Ringers which may be connected to a particular telephone line, which is needed to permit Terminal Equipment to operate in a manner compatible with Telephone Company communications facilities, shall be provided by the Telephone Company upon customer's request.

(b) Changes in Telephone Company Communications Facilities, Equipment, Operations and Procedures.

The Telephone Company may make changes in its communications facilities, equipment, operations or procedures, where such action is reasonably required in the operation of its business and is not inconsistent with the rules and regulations in FCC Part 68 of the FCC Rules and Regulations. If such changes can be reasonably expected to render any customer Terminal Equipment incompatible with Telephone Company Communications Facilities, or require modification or alteration of such Terminal Equipment, or otherwise materially affect its use or performance, the customer shall be given adequate notice in writing, to allow the customer an opportunity to maintain uninterrupted service.

OTHERS

- *Keep the unit away from heating appliances and electrical noise generating devices such as fluorescent lamps, motors and television. These noise sources can interfere with the performance of the EASA-PHONE.*
- *This unit should be kept free of dust, moisture, high temperature and vibration, and should not be exposed to direct sunlight.*
- *Never attempt to insert wires, pins, etc. into the vents or other holes of this unit.*
- *If there is trouble, disconnect the unit from the telephone line. Plug the telephone directly into the telephone line. If the telephone operates properly, do not reconnect the unit to the line until the trouble has been repaired by an authorized Panasonic Factory Service Center. If the telephone does not operate properly, chances are that the trouble is in the telephone system, and not in the unit.*
- *Do not use benzine, thinner, or similar solvents. Do not use abrasive powder to clean the cabinet. Wipe it with a soft cloth.*

“WARNING—This equipment generates, uses, and can radiate radio frequency energy and if not installed and used in accordance with the instructions manual, may cause interference to radio communications. It has been tested and found to comply with the limits for a Class A computing device pursuant to Subpart J of Part 15 of FCC Rules, which are designed to provide reasonable protection against such interference when operated in a commercial environment. Operation of this equipment in a residential area is likely to cause interference in which case the user at his own expense will be required to take whatever measures may be required to correct the interference.”

WARNING: TO PREVENT FIRE OR SHOCK HAZARD, DO NOT EXPOSE THIS PRODUCT TO RAIN OR MOISTURE.

LIMITED WARRANTY

Panasonic Company or Panasonic Sales Company (collectively referred to as "PANASONIC") will repair this product with new or rebuilt parts, free of charge, in the U.S.A. or Puerto Rico for one (1) year from the date of original purchase in the event of a defect in materials or workmanship.

Batteries (if included)—New rechargeable batteries in exchange for defective rechargeable batteries for ten (10) days from the date of original purchase. Non-rechargeable batteries are not warranted.

Carry-in or mail-in service in the U.S.A. can be obtained during the warranty period from a Matsushita Services Company (MSC) Factory Servicenter listed in the Servicenter Directory. Or call 1-800-447-4700, toll free, to locate an authorized MSC Servicenter. Carry-in or mail-in service in Puerto Rico can be obtained during the warranty period by calling the telephone numbers listed in the Servicenter Directory (see page 6-11).

This warranty is extended only to the original purchaser. A purchase receipt or other proof of date of original purchase will be required before warranty performance is rendered.

This warranty only covers failures due to defects in materials or workmanship which occur during normal use. It does not cover damage which occurs in shipment or failures which are caused by products not supplied by Panasonic Company, Panasonic Sales Company or failures which result from accident, misuse, abuse, neglect, mishandling, misapplication, alteration, faulty installation, modification, or service by anyone other than a MSC Factory Servicenter or authorized MSC Servicenter or damage that is attributable to acts of God.

LIMITS AND EXCLUSIONS

There are no express warranties except as listed above.

PANASONIC COMPANY AND PANASONIC SALES COMPANY SHALL NOT BE LIABLE FOR INCIDENTAL OR CONSEQUENTIAL DAMAGES RESULTING FROM THE USE OF THIS PRODUCT, OR ARISING OUT OF ANY BREACH OF THIS WARRANTY.

ALL EXPRESS AND IMPLIED WARRANTIES, INCLUDING THE WARRANTIES OF MERCHANTABILITY AND FITNESS FOR A PARTICULAR PURPOSE, ARE LIMITED TO THE APPLICABLE WARRANTY PERIOD SET FORTH ABOVE.

Some states do not allow the exclusion or limitation of incidental or consequential damages, or limitations on how long an implied warranty lasts, so the above exclusions or limitations may not apply to you.

This warranty gives you specific legal rights and you may also have other rights which vary from state to state.

If a problem with this product develops during the warranty period, you may contact your dealer or Servicenter. If the problem is not handled to your satisfaction, then write to the Consumer Affairs Division at the company address indicated on the back cover.

SERVICENTER LIST

To locate an Authorized Servicenter in Your Area within the Continental U.S.A.

DIAL TOLL FREE: 1-800-447-4700
24 Hours a Day, 7 Days a Week

Requests for assistance in obtaining repairs or technical information... contact any one of the following Service Administration offices:

NORTHEAST

2250 Cabot Blvd., West
Langhorne, PA 19047
215-741-0676

Covers:

CT, DE, ME, MD, MA,
NH, NJ, NY, PA, RI, VT,
VA, DC, WV, Eastern OH

MIDWEST

1703 N.Randell Road,
Elgin, IL 60123
708-468-5454

Covers:

IL, IN, IA, KS, KY, MI,
MN, MO, NE, ND, SD,
WI, Western OH

WESTERN

6550 Katella Avenue
Cypress, CA 90630
714-895-7438

Covers:

AK, AZ, CA, CO, ID,
MT, NV, NM, OR, UT,
WA, WY

SOUTHERN

1854 Shackle-Ford Court,
Suite 105
Norcross, GA 30093
404-717-6860

Covers:

AL, AR, FL, GA, LA,
MS, NC, SC, TN, TX,
OK

Consumers requiring product information or operating assistance with a consumer product should contact:

CONSUMER AFFAIRS DEPARTMENT 2F-3
50 Meadowland Parkway, Secaucus, N.J. 07094 (201) 348-9090

Service in Puerto Rico

MATSUSHITA ELECTRIC OF PUERTO RICO, INC.

Panasonic Sales Company/Factory Servicenter

San Gabriel Industrial Park 65th Infantry Avenue KM 9.5
Carolina, Puerto Rico 00630 809-750-5135

**Service in the Continental
U.S.A.... Factory Servicers**

MATSUSHITA SERVICES COMPANY

Division of Matsushita Electric Corporation of America
50 Meadowland Parkway, Secaucus,
New Jersey 07094

4245 International Blvd
Suite F
Norcross, GA 30093
(404) 717-6480

2250 Cabot Blvd., West
Langhorne, PA 19047
215-741-0676

13535 Marquaret Ave.,
Santa Fe Springs, CA 90670
213-921-8248
(mail-in service only)

Panasonic

Phone Number Directory

► TELEPHONE NUMBER ◀

CO	TEL NO.	NOTE	CO	TEL NO.	NOTE
1			4		
2			5		
3			6		

► EXTENSION NUMBER ◀

No.	NAME	NOTE	No.	NAME	NOTE
11			19		
12			20		
13			21		
14			22		
15			23		
16			24		
17			25		
18			26		

► SPEED DIALING ◀

CODE	NAME	TEL NO.	CODE	NAME	TEL NO.
00			16		
01			17		
02			18		
03			19		
04			20		
05			21		
06			22		
07			23		
08			24		
09			25		
10			26		
11			27		
12			28		
13			29		
14			30		
15			31		

Panasonic

▶ SPEED DIALING ◀

CODE	NAME	TEL NO.	CODE	NAME	TEL NO.
32			66		
33			67		
34			68		
35			69		
36			70		
37			71		
38			72		
39			73		
40			74		
41			75		
42			76		
43			77		
44			78		
45			79		
46			80		
47			81		
48			82		
49			83		
50			84		
51			85		
52			86		
53			87		
54			88		
55			89		
56			90		
57			91		
58			92		
59			93		
60			94		
61			95		
62			96		
63			97		
64			98		
65			99		

PROGRAMMING TABLE

TO SET	PROGRAM ADDRESS	STEPS REQUIRED TO CHANGE PROGRAM																																
Date and Time Setting	[00]	<p>[NEXT] [A] [↔] [SELECT] [↔] [B] [↔] [SELECT] [↔] [C] [↔] [D] [↔] [SELECT] [MEMORY] [END]</p> <p style="margin-left: 40px;"> year month day day of the week hour minute AM/PM </p>																																
System Speed Dialing Entry	[01] or [AUTO]	<p>[NEXT] [AB] [CD] [phone number] [MEMORY] [END]</p> <p style="margin-left: 40px;"> [9]: automatic line access number [81] through [86]: outside line access number speed access code [00 through 99] </p> <p>• There is the phone number directory on page 6-12.</p>																																
DSS Console Assignment	[02]	<p>[NEXT] [AB] [↔] [CD] [↔] [EF] [↔] [GH] [MEMORY] [END]</p> <p style="margin-left: 40px;"> Telephone extension number paired with console 2 Console 2 extension number Telephone extension number paired with console 1 Console 1 extension number </p> <table border="1" style="width: 100%; border-collapse: collapse; margin-top: 10px;"> <tr> <td style="width: 30%;"></td> <td style="width: 35%; text-align: center;">Console 1</td> <td style="width: 35%; text-align: center;">Telephone paired with console 1</td> </tr> <tr> <td>Extension number</td> <td></td> <td></td> </tr> <tr> <td colspan="3" style="height: 10px;"></td> </tr> <tr> <td></td> <td style="text-align: center;">Console 2</td> <td style="text-align: center;">Telephone paired with console 2</td> </tr> <tr> <td>Extension number</td> <td></td> <td></td> </tr> </table>		Console 1	Telephone paired with console 1	Extension number							Console 2	Telephone paired with console 2	Extension number																			
	Console 1	Telephone paired with console 1																																
Extension number																																		
	Console 2	Telephone paired with console 2																																
Extension number																																		
CO Connection Assignment	[03]	<p>[NEXT] [NEXT] [SELECT] [MEMORY] [END]</p> <p style="margin-left: 40px;"> CONNECT/NO CONNECT until the desired CO number appears </p> <table border="1" style="width: 100%; border-collapse: collapse; margin-top: 10px;"> <tr> <td style="width: 30%;"></td> <td style="width: 10%; text-align: center;">Default</td> <td colspan="6" style="width: 60%; text-align: center;">To make program change</td> </tr> <tr> <td>CO (s)</td> <td style="text-align: center;">all CO's</td> <td style="text-align: center;">1</td> <td style="text-align: center;">2</td> <td style="text-align: center;">3</td> <td style="text-align: center;">4</td> <td style="text-align: center;">5</td> <td style="text-align: center;">6</td> </tr> <tr> <td>Connect</td> <td style="text-align: center;">x</td> <td></td> <td></td> <td></td> <td></td> <td></td> <td></td> </tr> <tr> <td>No connect</td> <td></td> <td></td> <td></td> <td></td> <td></td> <td></td> <td></td> </tr> </table>		Default	To make program change						CO (s)	all CO's	1	2	3	4	5	6	Connect	x							No connect							
	Default	To make program change																																
CO (s)	all CO's	1	2	3	4	5	6																											
Connect	x																																	
No connect																																		
Dial Mode (Tone/Pulse) Selection	[04]	<p>[NEXT] [NEXT] [SELECT] [MEMORY] [END]</p> <p style="margin-left: 40px;"> TONE/PULSE until the desired CO number appears </p> <table border="1" style="width: 100%; border-collapse: collapse; margin-top: 10px;"> <tr> <td style="width: 30%;"></td> <td style="width: 10%; text-align: center;">Default</td> <td colspan="6" style="width: 60%; text-align: center;">To make program change</td> </tr> <tr> <td>CO (s)</td> <td style="text-align: center;">all CO's</td> <td style="text-align: center;">1</td> <td style="text-align: center;">2</td> <td style="text-align: center;">3</td> <td style="text-align: center;">4</td> <td style="text-align: center;">5</td> <td style="text-align: center;">6</td> </tr> <tr> <td>Tone (DTMF) mode</td> <td style="text-align: center;">x</td> <td></td> <td></td> <td></td> <td></td> <td></td> <td></td> </tr> <tr> <td>Pulse mode</td> <td></td> <td></td> <td></td> <td></td> <td></td> <td></td> <td></td> </tr> </table>		Default	To make program change						CO (s)	all CO's	1	2	3	4	5	6	Tone (DTMF) mode	x							Pulse mode							
	Default	To make program change																																
CO (s)	all CO's	1	2	3	4	5	6																											
Tone (DTMF) mode	x																																	
Pulse mode																																		
Switching Mode (Day/Night Service)	[05]	<p>[NEXT] [SELECT] [MEMORY] [END]</p> <p style="margin-left: 40px;">MAN/AUTO</p> <table border="1" style="width: 100%; border-collapse: collapse; margin-top: 10px;"> <tr> <td style="width: 30%;"></td> <td style="width: 10%; text-align: center;">Default</td> <td style="width: 60%; text-align: center;">To make program change</td> </tr> <tr> <td>Manual</td> <td style="text-align: center;">x</td> <td></td> </tr> <tr> <td>Automatic</td> <td></td> <td></td> </tr> </table>		Default	To make program change	Manual	x		Automatic																									
	Default	To make program change																																
Manual	x																																	
Automatic																																		
Starting Time (Day/Night Service)	[06]	<p>[NEXT] [A] [↔] [B] [↔] [SELECT] [MEMORY] [NEXT] [C] [↔] [D] [↔] [SELECT] [MEMORY] [END]</p> <p style="margin-left: 40px;"> minute AM/PM minute AM/PM </p> <p style="margin-left: 40px;"> starting time for day service (hour) starting time for night service (hour) </p> <table border="1" style="width: 100%; border-collapse: collapse; margin-top: 10px;"> <tr> <td style="width: 30%;"></td> <td style="width: 10%; text-align: center;">Default</td> <td style="width: 60%; text-align: center;">To make program change</td> </tr> <tr> <td>Day Plan</td> <td style="text-align: center;">9:00 AM</td> <td></td> </tr> <tr> <td>Night plan</td> <td style="text-align: center;">5:00 PM</td> <td></td> </tr> </table>		Default	To make program change	Day Plan	9:00 AM		Night plan	5:00 PM																								
	Default	To make program change																																
Day Plan	9:00 AM																																	
Night plan	5:00 PM																																	

TO SET	PROGRAM ADDRESS	STEPS REQUIRED TO CHANGE PROGRAM																																																																																																																																																
Flexible Day Outward Dialing Assignment	[07]	<p>[NEXT] [NEXT] [C...E] [MEMORY] [END] ----- CO number ----- until the desired extension number appears</p> <table border="1"> <thead> <tr> <th></th> <th>Default</th> <th colspan="16">To make program change</th> </tr> <tr> <th>Extensions</th> <th>all extensions</th> <th>11</th><th>12</th><th>13</th><th>14</th><th>15</th><th>16</th><th>17</th><th>18</th><th>19</th><th>20</th><th>21</th><th>22</th><th>23</th><th>24</th><th>25</th><th>26</th> </tr> </thead> <tbody> <tr><td>CO 1</td><td>x</td><td></td><td></td><td></td><td></td><td></td><td></td><td></td><td></td><td></td><td></td><td></td><td></td><td></td><td></td><td></td><td></td></tr> <tr><td>CO 2</td><td>x</td><td></td><td></td><td></td><td></td><td></td><td></td><td></td><td></td><td></td><td></td><td></td><td></td><td></td><td></td><td></td><td></td></tr> <tr><td>CO 3</td><td>x</td><td></td><td></td><td></td><td></td><td></td><td></td><td></td><td></td><td></td><td></td><td></td><td></td><td></td><td></td><td></td><td></td></tr> <tr><td>CO 4</td><td>x</td><td></td><td></td><td></td><td></td><td></td><td></td><td></td><td></td><td></td><td></td><td></td><td></td><td></td><td></td><td></td><td></td></tr> <tr><td>CO 5</td><td>x</td><td></td><td></td><td></td><td></td><td></td><td></td><td></td><td></td><td></td><td></td><td></td><td></td><td></td><td></td><td></td><td></td></tr> <tr><td>CO 6</td><td>x</td><td></td><td></td><td></td><td></td><td></td><td></td><td></td><td></td><td></td><td></td><td></td><td></td><td></td><td></td><td></td><td></td></tr> </tbody> </table>		Default	To make program change																Extensions	all extensions	11	12	13	14	15	16	17	18	19	20	21	22	23	24	25	26	CO 1	x																	CO 2	x																	CO 3	x																	CO 4	x																	CO 5	x																	CO 6	x																
	Default	To make program change																																																																																																																																																
Extensions	all extensions	11	12	13	14	15	16	17	18	19	20	21	22	23	24	25	26																																																																																																																																	
CO 1	x																																																																																																																																																	
CO 2	x																																																																																																																																																	
CO 3	x																																																																																																																																																	
CO 4	x																																																																																																																																																	
CO 5	x																																																																																																																																																	
CO 6	x																																																																																																																																																	
Flexible Night Outward Dialing Assignment	[08]	<p>[NEXT] [NEXT] [C...E] [MEMORY] [END] ----- CO number ----- until the desired extension number appears</p> <table border="1"> <thead> <tr> <th></th> <th>Default</th> <th colspan="16">To make program change</th> </tr> <tr> <th>Extensions</th> <th>all extensions</th> <th>11</th><th>12</th><th>13</th><th>14</th><th>15</th><th>16</th><th>17</th><th>18</th><th>19</th><th>20</th><th>21</th><th>22</th><th>23</th><th>24</th><th>25</th><th>26</th> </tr> </thead> <tbody> <tr><td>CO 1</td><td>x</td><td></td><td></td><td></td><td></td><td></td><td></td><td></td><td></td><td></td><td></td><td></td><td></td><td></td><td></td><td></td><td></td></tr> <tr><td>CO 2</td><td>x</td><td></td><td></td><td></td><td></td><td></td><td></td><td></td><td></td><td></td><td></td><td></td><td></td><td></td><td></td><td></td><td></td></tr> <tr><td>CO 3</td><td>x</td><td></td><td></td><td></td><td></td><td></td><td></td><td></td><td></td><td></td><td></td><td></td><td></td><td></td><td></td><td></td><td></td></tr> <tr><td>CO 4</td><td>x</td><td></td><td></td><td></td><td></td><td></td><td></td><td></td><td></td><td></td><td></td><td></td><td></td><td></td><td></td><td></td><td></td></tr> <tr><td>CO 5</td><td>x</td><td></td><td></td><td></td><td></td><td></td><td></td><td></td><td></td><td></td><td></td><td></td><td></td><td></td><td></td><td></td><td></td></tr> <tr><td>CO 6</td><td>x</td><td></td><td></td><td></td><td></td><td></td><td></td><td></td><td></td><td></td><td></td><td></td><td></td><td></td><td></td><td></td><td></td></tr> </tbody> </table>		Default	To make program change																Extensions	all extensions	11	12	13	14	15	16	17	18	19	20	21	22	23	24	25	26	CO 1	x																	CO 2	x																	CO 3	x																	CO 4	x																	CO 5	x																	CO 6	x																
	Default	To make program change																																																																																																																																																
Extensions	all extensions	11	12	13	14	15	16	17	18	19	20	21	22	23	24	25	26																																																																																																																																	
CO 1	x																																																																																																																																																	
CO 2	x																																																																																																																																																	
CO 3	x																																																																																																																																																	
CO 4	x																																																																																																																																																	
CO 5	x																																																																																																																																																	
CO 6	x																																																																																																																																																	
Flexible Day Ringing Assignment	[09]	<p>[NEXT] [NEXT] [C...E] [MEMORY] [END] ----- CO number ----- until the desired extension number appears</p> <table border="1"> <thead> <tr> <th></th> <th>Default</th> <th colspan="16">To make program change</th> </tr> <tr> <th>Extensions</th> <th>all extensions</th> <th>11</th><th>12</th><th>13</th><th>14</th><th>15</th><th>16</th><th>17</th><th>18</th><th>19</th><th>20</th><th>21</th><th>22</th><th>23</th><th>24</th><th>25</th><th>26</th> </tr> </thead> <tbody> <tr><td>CO 1</td><td>x</td><td></td><td></td><td></td><td></td><td></td><td></td><td></td><td></td><td></td><td></td><td></td><td></td><td></td><td></td><td></td><td></td></tr> <tr><td>CO 2</td><td>x</td><td></td><td></td><td></td><td></td><td></td><td></td><td></td><td></td><td></td><td></td><td></td><td></td><td></td><td></td><td></td><td></td></tr> <tr><td>CO 3</td><td>x</td><td></td><td></td><td></td><td></td><td></td><td></td><td></td><td></td><td></td><td></td><td></td><td></td><td></td><td></td><td></td><td></td></tr> <tr><td>CO 4</td><td>x</td><td></td><td></td><td></td><td></td><td></td><td></td><td></td><td></td><td></td><td></td><td></td><td></td><td></td><td></td><td></td><td></td></tr> <tr><td>CO 5</td><td>x</td><td></td><td></td><td></td><td></td><td></td><td></td><td></td><td></td><td></td><td></td><td></td><td></td><td></td><td></td><td></td><td></td></tr> <tr><td>CO 6</td><td>x</td><td></td><td></td><td></td><td></td><td></td><td></td><td></td><td></td><td></td><td></td><td></td><td></td><td></td><td></td><td></td><td></td></tr> </tbody> </table>		Default	To make program change																Extensions	all extensions	11	12	13	14	15	16	17	18	19	20	21	22	23	24	25	26	CO 1	x																	CO 2	x																	CO 3	x																	CO 4	x																	CO 5	x																	CO 6	x																
	Default	To make program change																																																																																																																																																
Extensions	all extensions	11	12	13	14	15	16	17	18	19	20	21	22	23	24	25	26																																																																																																																																	
CO 1	x																																																																																																																																																	
CO 2	x																																																																																																																																																	
CO 3	x																																																																																																																																																	
CO 4	x																																																																																																																																																	
CO 5	x																																																																																																																																																	
CO 6	x																																																																																																																																																	
Flexible Night Ringing Assignment	[10]	<p>[NEXT] [NEXT] [C...E] [MEMORY] [END] ----- CO number ----- until the desired extension number appears</p> <table border="1"> <thead> <tr> <th></th> <th>Default</th> <th colspan="16">To make program change</th> </tr> <tr> <th>Extensions</th> <th>all extensions</th> <th>11</th><th>12</th><th>13</th><th>14</th><th>15</th><th>16</th><th>17</th><th>18</th><th>19</th><th>20</th><th>21</th><th>22</th><th>23</th><th>24</th><th>25</th><th>26</th> </tr> </thead> <tbody> <tr><td>CO 1</td><td>x</td><td></td><td></td><td></td><td></td><td></td><td></td><td></td><td></td><td></td><td></td><td></td><td></td><td></td><td></td><td></td><td></td></tr> <tr><td>CO 2</td><td>x</td><td></td><td></td><td></td><td></td><td></td><td></td><td></td><td></td><td></td><td></td><td></td><td></td><td></td><td></td><td></td><td></td></tr> <tr><td>CO 3</td><td>x</td><td></td><td></td><td></td><td></td><td></td><td></td><td></td><td></td><td></td><td></td><td></td><td></td><td></td><td></td><td></td><td></td></tr> <tr><td>CO 4</td><td>x</td><td></td><td></td><td></td><td></td><td></td><td></td><td></td><td></td><td></td><td></td><td></td><td></td><td></td><td></td><td></td><td></td></tr> <tr><td>CO 5</td><td>x</td><td></td><td></td><td></td><td></td><td></td><td></td><td></td><td></td><td></td><td></td><td></td><td></td><td></td><td></td><td></td><td></td></tr> <tr><td>CO 6</td><td>x</td><td></td><td></td><td></td><td></td><td></td><td></td><td></td><td></td><td></td><td></td><td></td><td></td><td></td><td></td><td></td><td></td></tr> </tbody> </table>		Default	To make program change																Extensions	all extensions	11	12	13	14	15	16	17	18	19	20	21	22	23	24	25	26	CO 1	x																	CO 2	x																	CO 3	x																	CO 4	x																	CO 5	x																	CO 6	x																
	Default	To make program change																																																																																																																																																
Extensions	all extensions	11	12	13	14	15	16	17	18	19	20	21	22	23	24	25	26																																																																																																																																	
CO 1	x																																																																																																																																																	
CO 2	x																																																																																																																																																	
CO 3	x																																																																																																																																																	
CO 4	x																																																																																																																																																	
CO 5	x																																																																																																																																																	
CO 6	x																																																																																																																																																	
Toll Restriction--Class Assignment	[11]	<p>[NEXT] [NEXT] [SELECT] [MEMORY] [END] ----- CLASS 1/2/3/4 ----- until the desired extension number appears</p> <table border="1"> <thead> <tr> <th></th> <th>Default</th> <th colspan="16">To make program change</th> </tr> <tr> <th>Extensions</th> <th>all extensions</th> <th>11</th><th>12</th><th>13</th><th>14</th><th>15</th><th>16</th><th>17</th><th>18</th><th>19</th><th>20</th><th>21</th><th>22</th><th>23</th><th>24</th><th>25</th><th>26</th> </tr> </thead> <tbody> <tr><td>Class 1 (all calls)</td><td>x</td><td></td><td></td><td></td><td></td><td></td><td></td><td></td><td></td><td></td><td></td><td></td><td></td><td></td><td></td><td></td><td></td></tr> <tr><td>Class 2 (toll calls, local calls)</td><td></td><td></td><td></td><td></td><td></td><td></td><td></td><td></td><td></td><td></td><td></td><td></td><td></td><td></td><td></td><td></td><td></td></tr> <tr><td>Class 3 (selected area-codes, local calls)</td><td></td><td></td><td></td><td></td><td></td><td></td><td></td><td></td><td></td><td></td><td></td><td></td><td></td><td></td><td></td><td></td><td></td></tr> <tr><td>Class 4 (local calls)</td><td></td><td></td><td></td><td></td><td></td><td></td><td></td><td></td><td></td><td></td><td></td><td></td><td></td><td></td><td></td><td></td><td></td></tr> </tbody> </table>		Default	To make program change																Extensions	all extensions	11	12	13	14	15	16	17	18	19	20	21	22	23	24	25	26	Class 1 (all calls)	x																	Class 2 (toll calls, local calls)																		Class 3 (selected area-codes, local calls)																		Class 4 (local calls)																																																					
	Default	To make program change																																																																																																																																																
Extensions	all extensions	11	12	13	14	15	16	17	18	19	20	21	22	23	24	25	26																																																																																																																																	
Class 1 (all calls)	x																																																																																																																																																	
Class 2 (toll calls, local calls)																																																																																																																																																		
Class 3 (selected area-codes, local calls)																																																																																																																																																		
Class 4 (local calls)																																																																																																																																																		

TO SET	PROGRAM ADDRESS	STEPS REQUIRED TO CHANGE PROGRAM																																																																							
Toll Restriction— Area Code Selection	[12]	<p>[NEXT] [SELECT] [AB] [C] [MEMORY] [END] ↳ area code with 3 digits ↳ Memory location number</p> <table border="1" data-bbox="379 449 1412 561"> <thead> <tr> <th rowspan="2"></th> <th colspan="10">Memory location number</th> </tr> <tr> <th>00</th> <th>01</th> <th>02</th> <th>03</th> <th>04</th> <th>05</th> <th>06</th> <th>07</th> <th>08</th> <th>09</th> </tr> </thead> <tbody> <tr> <td>Area code entry</td> <td></td> <td></td> <td></td> <td></td> <td></td> <td></td> <td></td> <td></td> <td></td> <td></td> </tr> </tbody> </table>		Memory location number										00	01	02	03	04	05	06	07	08	09	Area code entry																																																	
	Memory location number																																																																								
	00	01	02	03	04	05	06	07	08	09																																																															
Area code entry																																																																									
Programmable Toll Prefix	[13]	<p>[NEXT] [SELECT] [MEMORY] [END] ↳ WITH // WITHOUT 1</p> <table border="1" data-bbox="379 644 1125 725"> <thead> <tr> <th></th> <th>Default</th> <th>To make program change</th> </tr> </thead> <tbody> <tr> <td>With 1</td> <td>x</td> <td></td> </tr> <tr> <td>Without 1</td> <td></td> <td></td> </tr> </tbody> </table>		Default	To make program change	With 1	x		Without 1																																																																
	Default	To make program change																																																																							
With 1	x																																																																								
Without 1																																																																									
Programmable Operator Call	[14]	<p>[NEXT] [NEXT] [SELECT] [MEMORY] [END] ↳ ENABLE/DISABLE ↳ until the desired extension number appears</p> <table border="1" data-bbox="384 853 1422 959"> <thead> <tr> <th rowspan="2"></th> <th>Default</th> <th colspan="16">To make program change</th> </tr> <tr> <th>all extensions</th> <th>11</th> <th>12</th> <th>13</th> <th>14</th> <th>15</th> <th>16</th> <th>17</th> <th>18</th> <th>19</th> <th>20</th> <th>21</th> <th>22</th> <th>23</th> <th>24</th> <th>25</th> <th>26</th> </tr> </thead> <tbody> <tr> <td>Enable</td> <td>x</td> <td></td> <td></td> <td></td> <td></td> <td></td> <td></td> <td></td> <td></td> <td></td> <td></td> <td></td> <td></td> <td></td> <td></td> <td></td> <td></td> </tr> <tr> <td>Disable</td> <td></td> <td></td> <td></td> <td></td> <td></td> <td></td> <td></td> <td></td> <td></td> <td></td> <td></td> <td></td> <td></td> <td></td> <td></td> <td></td> <td></td> </tr> </tbody> </table>		Default	To make program change																all extensions	11	12	13	14	15	16	17	18	19	20	21	22	23	24	25	26	Enable	x																	Disable																	
	Default	To make program change																																																																							
	all extensions	11	12	13	14	15	16	17	18	19	20	21	22	23	24	25	26																																																								
Enable	x																																																																								
Disable																																																																									
Programmable Directory Assistance	[15]	<p>[NEXT] [SELECT] [MEMORY] [END] ↳ NO RESTRICT/RESTRICT</p> <table border="1" data-bbox="384 1093 1129 1174"> <thead> <tr> <th></th> <th>Default</th> <th>To make program change</th> </tr> </thead> <tbody> <tr> <td>No restrict</td> <td>x</td> <td></td> </tr> <tr> <td>Restrict</td> <td></td> <td></td> </tr> </tbody> </table>		Default	To make program change	No restrict	x		Restrict																																																																
	Default	To make program change																																																																							
No restrict	x																																																																								
Restrict																																																																									
Automatic Answering (Automatic/ Manual) Selection	[16]	<p>[NEXT] [NEXT] [SELECT] [MEMORY] [END] ↳ AUTO ANSWER/MAN ANSWER ↳ until the desired extension number appears</p> <table border="1" data-bbox="384 1330 1422 1436"> <thead> <tr> <th rowspan="2"></th> <th>Default</th> <th colspan="16">To make program change</th> </tr> <tr> <th>all extensions</th> <th>11</th> <th>12</th> <th>13</th> <th>14</th> <th>15</th> <th>16</th> <th>17</th> <th>18</th> <th>19</th> <th>20</th> <th>21</th> <th>22</th> <th>23</th> <th>24</th> <th>25</th> <th>26</th> </tr> </thead> <tbody> <tr> <td>Automatic</td> <td>x</td> <td></td> <td></td> <td></td> <td></td> <td></td> <td></td> <td></td> <td></td> <td></td> <td></td> <td></td> <td></td> <td></td> <td></td> <td></td> <td></td> </tr> <tr> <td>Manual</td> <td></td> <td></td> <td></td> <td></td> <td></td> <td></td> <td></td> <td></td> <td></td> <td></td> <td></td> <td></td> <td></td> <td></td> <td></td> <td></td> <td></td> </tr> </tbody> </table>		Default	To make program change																all extensions	11	12	13	14	15	16	17	18	19	20	21	22	23	24	25	26	Automatic	x																	Manual																	
	Default	To make program change																																																																							
	all extensions	11	12	13	14	15	16	17	18	19	20	21	22	23	24	25	26																																																								
Automatic	x																																																																								
Manual																																																																									
Host PBX Access Codes Assignment	[17]	<p>[NEXT] [NEXT] [A...D] [MEMORY] [END] ↳ up to four outside access codes each with a maximum of 2 digits ↳ until the desired CO numbers appears</p> <table border="1" data-bbox="389 1583 1137 1770"> <thead> <tr> <th>CO</th> <th colspan="5">Outside access codes of the host PBX</th> </tr> </thead> <tbody> <tr><td>1</td><td></td><td></td><td></td><td></td><td></td></tr> <tr><td>2</td><td></td><td></td><td></td><td></td><td></td></tr> <tr><td>3</td><td></td><td></td><td></td><td></td><td></td></tr> <tr><td>4</td><td></td><td></td><td></td><td></td><td></td></tr> <tr><td>5</td><td></td><td></td><td></td><td></td><td></td></tr> <tr><td>6</td><td></td><td></td><td></td><td></td><td></td></tr> </tbody> </table>	CO	Outside access codes of the host PBX					1						2						3						4						5						6																																		
CO	Outside access codes of the host PBX																																																																								
1																																																																									
2																																																																									
3																																																																									
4																																																																									
5																																																																									
6																																																																									

TO SET	PROGRAM ADDRESS	STEPS REQUIRED TO CHANGE PROGRAM																																																																																																																																																																										
Preferred CO Line Assignment	[18]	<p>[NEXT] [NEXT] [SELECT] [MEMORY] [END] ----- (none)/CO 1/CO 2/CO 3/CO 4/CO 5/CO 6 --- until the desired extension number appears</p> <table border="1" data-bbox="464 421 1486 666"> <thead> <tr> <th></th> <th>Default</th> <th colspan="24">To make program change</th> </tr> <tr> <th>Extensions</th> <th>all extensions</th> <th>11</th><th>12</th><th>13</th><th>14</th><th>15</th><th>16</th><th>17</th><th>18</th><th>19</th><th>20</th><th>21</th><th>22</th><th>23</th><th>24</th><th>25</th><th>26</th> </tr> </thead> <tbody> <tr> <td>• • • (none)</td> <td>x</td> <td></td><td></td><td></td><td></td><td></td><td></td><td></td><td></td><td></td><td></td><td></td><td></td><td></td><td></td><td></td><td></td> </tr> <tr><td>CO 1</td><td></td><td></td><td></td><td></td><td></td><td></td><td></td><td></td><td></td><td></td><td></td><td></td><td></td><td></td><td></td><td></td><td></td></tr> <tr><td>CO 2</td><td></td><td></td><td></td><td></td><td></td><td></td><td></td><td></td><td></td><td></td><td></td><td></td><td></td><td></td><td></td><td></td><td></td></tr> <tr><td>CO 3</td><td></td><td></td><td></td><td></td><td></td><td></td><td></td><td></td><td></td><td></td><td></td><td></td><td></td><td></td><td></td><td></td><td></td></tr> <tr><td>CO 4</td><td></td><td></td><td></td><td></td><td></td><td></td><td></td><td></td><td></td><td></td><td></td><td></td><td></td><td></td><td></td><td></td><td></td></tr> <tr><td>CO 5</td><td></td><td></td><td></td><td></td><td></td><td></td><td></td><td></td><td></td><td></td><td></td><td></td><td></td><td></td><td></td><td></td><td></td></tr> <tr><td>CO 6</td><td></td><td></td><td></td><td></td><td></td><td></td><td></td><td></td><td></td><td></td><td></td><td></td><td></td><td></td><td></td><td></td><td></td></tr> </tbody> </table>		Default	To make program change																								Extensions	all extensions	11	12	13	14	15	16	17	18	19	20	21	22	23	24	25	26	• • • (none)	x																	CO 1																		CO 2																		CO 3																		CO 4																		CO 5																		CO 6																	
	Default	To make program change																																																																																																																																																																										
Extensions	all extensions	11	12	13	14	15	16	17	18	19	20	21	22	23	24	25	26																																																																																																																																																											
• • • (none)	x																																																																																																																																																																											
CO 1																																																																																																																																																																												
CO 2																																																																																																																																																																												
CO 3																																																																																																																																																																												
CO 4																																																																																																																																																																												
CO 5																																																																																																																																																																												
CO 6																																																																																																																																																																												
Programmable Call Waiting	[19]	<p>[NEXT] [NEXT] [SELECT] [MEMORY] [END] ----- EXT.-OFF, CO-OFF/EXT.-ON, CO-OFF/EXT.-OFF, CO-ON/EXT.-ON, CO-ON --- until the desired extension number appears</p> <table border="1" data-bbox="464 804 1486 966"> <thead> <tr> <th></th> <th>Default</th> <th colspan="24">To make program change</th> </tr> <tr> <th>Extensions</th> <th>all extensions</th> <th>11</th><th>12</th><th>13</th><th>14</th><th>15</th><th>16</th><th>17</th><th>18</th><th>19</th><th>20</th><th>21</th><th>22</th><th>23</th><th>24</th><th>25</th><th>26</th> </tr> </thead> <tbody> <tr> <td>EXT.-OFF, CO-OFF</td> <td>x</td> <td></td><td></td><td></td><td></td><td></td><td></td><td></td><td></td><td></td><td></td><td></td><td></td><td></td><td></td><td></td><td></td> </tr> <tr><td>EXT.-ON, CO-OFF</td><td></td><td></td><td></td><td></td><td></td><td></td><td></td><td></td><td></td><td></td><td></td><td></td><td></td><td></td><td></td><td></td><td></td></tr> <tr><td>EXT.-OFF, CO-ON</td><td></td><td></td><td></td><td></td><td></td><td></td><td></td><td></td><td></td><td></td><td></td><td></td><td></td><td></td><td></td><td></td><td></td></tr> <tr><td>EXT.-ON, CO-ON</td><td></td><td></td><td></td><td></td><td></td><td></td><td></td><td></td><td></td><td></td><td></td><td></td><td></td><td></td><td></td><td></td><td></td></tr> </tbody> </table>		Default	To make program change																								Extensions	all extensions	11	12	13	14	15	16	17	18	19	20	21	22	23	24	25	26	EXT.-OFF, CO-OFF	x																	EXT.-ON, CO-OFF																		EXT.-OFF, CO-ON																		EXT.-ON, CO-ON																																																																							
	Default	To make program change																																																																																																																																																																										
Extensions	all extensions	11	12	13	14	15	16	17	18	19	20	21	22	23	24	25	26																																																																																																																																																											
EXT.-OFF, CO-OFF	x																																																																																																																																																																											
EXT.-ON, CO-OFF																																																																																																																																																																												
EXT.-OFF, CO-ON																																																																																																																																																																												
EXT.-ON, CO-ON																																																																																																																																																																												
Delayed Ringing Assignment	[20]	<p>[NEXT] [NEXT] [A...F] [MEMORY] [END] ----- dial the CO number --- until the desired extension number appears</p> <table border="1" data-bbox="464 1064 1486 1306"> <thead> <tr> <th></th> <th>Default</th> <th colspan="24">To make program change</th> </tr> <tr> <th>Extensions</th> <th>all extensions</th> <th>11</th><th>12</th><th>13</th><th>14</th><th>15</th><th>16</th><th>17</th><th>18</th><th>19</th><th>20</th><th>21</th><th>22</th><th>23</th><th>24</th><th>25</th><th>26</th> </tr> </thead> <tbody> <tr> <td>• • • (none)</td> <td>x</td> <td></td><td></td><td></td><td></td><td></td><td></td><td></td><td></td><td></td><td></td><td></td><td></td><td></td><td></td><td></td><td></td> </tr> <tr><td>CO 1</td><td></td><td></td><td></td><td></td><td></td><td></td><td></td><td></td><td></td><td></td><td></td><td></td><td></td><td></td><td></td><td></td><td></td></tr> <tr><td>CO 2</td><td></td><td></td><td></td><td></td><td></td><td></td><td></td><td></td><td></td><td></td><td></td><td></td><td></td><td></td><td></td><td></td><td></td></tr> <tr><td>CO 3</td><td></td><td></td><td></td><td></td><td></td><td></td><td></td><td></td><td></td><td></td><td></td><td></td><td></td><td></td><td></td><td></td><td></td></tr> <tr><td>CO 4</td><td></td><td></td><td></td><td></td><td></td><td></td><td></td><td></td><td></td><td></td><td></td><td></td><td></td><td></td><td></td><td></td><td></td></tr> <tr><td>CO 5</td><td></td><td></td><td></td><td></td><td></td><td></td><td></td><td></td><td></td><td></td><td></td><td></td><td></td><td></td><td></td><td></td><td></td></tr> <tr><td>CO 6</td><td></td><td></td><td></td><td></td><td></td><td></td><td></td><td></td><td></td><td></td><td></td><td></td><td></td><td></td><td></td><td></td><td></td></tr> </tbody> </table>		Default	To make program change																								Extensions	all extensions	11	12	13	14	15	16	17	18	19	20	21	22	23	24	25	26	• • • (none)	x																	CO 1																		CO 2																		CO 3																		CO 4																		CO 5																		CO 6																	
	Default	To make program change																																																																																																																																																																										
Extensions	all extensions	11	12	13	14	15	16	17	18	19	20	21	22	23	24	25	26																																																																																																																																																											
• • • (none)	x																																																																																																																																																																											
CO 1																																																																																																																																																																												
CO 2																																																																																																																																																																												
CO 3																																																																																																																																																																												
CO 4																																																																																																																																																																												
CO 5																																																																																																																																																																												
CO 6																																																																																																																																																																												
Delayed Ringing Count Selection	[21]	<p>[NEXT][SELECT][MEMORY][END] ----- AFTER 1 RING/AFTER 2 RINGS/AFTER 3 RINGS/AFTER 4 RINGS</p> <table border="1" data-bbox="475 1389 1208 1525"> <thead> <tr> <th></th> <th>Default</th> <th>To make program change</th> </tr> </thead> <tbody> <tr> <td>After 1 ring</td> <td></td> <td></td> </tr> <tr> <td>After 2 rings</td> <td>x</td> <td></td> </tr> <tr> <td>After 3 rings</td> <td></td> <td></td> </tr> <tr> <td>After 4 rings</td> <td></td> <td></td> </tr> </tbody> </table>		Default	To make program change	After 1 ring			After 2 rings	x		After 3 rings			After 4 rings																																																																																																																																																													
	Default	To make program change																																																																																																																																																																										
After 1 ring																																																																																																																																																																												
After 2 rings	x																																																																																																																																																																											
After 3 rings																																																																																																																																																																												
After 4 rings																																																																																																																																																																												
Intercom Alerting Mode	[22]	<p>[NEXT] [NEXT] [SELECT] [MEMORY] [END] ----- TONE CALL/VOICE CALL --- until the desired extension number appears</p> <table border="1" data-bbox="475 1636 1500 1742"> <thead> <tr> <th></th> <th>Default</th> <th colspan="24">To make program change</th> </tr> <tr> <th>Extensions</th> <th>all extensions</th> <th>11</th><th>12</th><th>13</th><th>14</th><th>15</th><th>16</th><th>17</th><th>18</th><th>19</th><th>20</th><th>21</th><th>22</th><th>23</th><th>24</th><th>25</th><th>26</th> </tr> </thead> <tbody> <tr> <td>Tone call</td> <td>x</td> <td></td><td></td><td></td><td></td><td></td><td></td><td></td><td></td><td></td><td></td><td></td><td></td><td></td><td></td><td></td><td></td> </tr> <tr><td>Voice call</td><td></td><td></td><td></td><td></td><td></td><td></td><td></td><td></td><td></td><td></td><td></td><td></td><td></td><td></td><td></td><td></td><td></td></tr> </tbody> </table>		Default	To make program change																								Extensions	all extensions	11	12	13	14	15	16	17	18	19	20	21	22	23	24	25	26	Tone call	x																	Voice call																																																																																																											
	Default	To make program change																																																																																																																																																																										
Extensions	all extensions	11	12	13	14	15	16	17	18	19	20	21	22	23	24	25	26																																																																																																																																																											
Tone call	x																																																																																																																																																																											
Voice call																																																																																																																																																																												
Programmable Doorphone	[23]	<p>[NEXT] [NEXT] [SELECT] [MEMORY] [END] ----- D-PHONE 1, 2/1/2/ • • • (deny the ringing) --- until the desired extension number appears</p> <table border="1" data-bbox="475 1864 1500 2021"> <thead> <tr> <th></th> <th>Default</th> <th colspan="24">To make program change</th> </tr> <tr> <th>Extensions</th> <th>all extensions</th> <th>11</th><th>12</th><th>13</th><th>14</th><th>15</th><th>16</th><th>17</th><th>18</th><th>19</th><th>20</th><th>21</th><th>22</th><th>23</th><th>24</th><th>25</th><th>26</th> </tr> </thead> <tbody> <tr> <td>Doorphone 1</td> <td>x</td> <td></td><td></td><td></td><td></td><td></td><td></td><td></td><td></td><td></td><td></td><td></td><td></td><td></td><td></td><td></td><td></td> </tr> <tr> <td>Doorphone 2</td> <td>x</td> <td></td><td></td><td></td><td></td><td></td><td></td><td></td><td></td><td></td><td></td><td></td><td></td><td></td><td></td><td></td><td></td> </tr> <tr> <td>Deny the ringing</td> <td></td> <td></td><td></td><td></td><td></td><td></td><td></td><td></td><td></td><td></td><td></td><td></td><td></td><td></td><td></td><td></td><td></td> </tr> </tbody> </table>		Default	To make program change																								Extensions	all extensions	11	12	13	14	15	16	17	18	19	20	21	22	23	24	25	26	Doorphone 1	x																	Doorphone 2	x																	Deny the ringing																																																																																									
	Default	To make program change																																																																																																																																																																										
Extensions	all extensions	11	12	13	14	15	16	17	18	19	20	21	22	23	24	25	26																																																																																																																																																											
Doorphone 1	x																																																																																																																																																																											
Doorphone 2	x																																																																																																																																																																											
Deny the ringing																																																																																																																																																																												

TO SET	PROGRAM ADDRESS	STEPS REQUIRED TO CHANGE PROGRAM																																																																																																												
Dial Call Pickup Group Assignment	[24]	<p>[NEXT] [NEXT] [A...D] [MEMORY] [END] ----- dial the pickup group number ----- until the desired extension number appears</p> <table border="1"> <thead> <tr> <th></th> <th>Default</th> <th colspan="16">To make program change</th> </tr> <tr> <th>Extensions</th> <td>all extensions</td> <td>11</td><td>12</td><td>13</td><td>14</td><td>15</td><td>16</td><td>17</td><td>18</td><td>19</td><td>20</td><td>21</td><td>22</td><td>23</td><td>24</td><td>25</td><td>26</td> </tr> </thead> <tbody> <tr> <td>Pickup Group 1</td> <td>x</td> <td></td><td></td><td></td><td></td><td></td><td></td><td></td><td></td><td></td><td></td><td></td><td></td><td></td><td></td><td></td><td></td> </tr> <tr> <td>Pickup Group 2</td> <td></td> <td></td><td></td><td></td><td></td><td></td><td></td><td></td><td></td><td></td><td></td><td></td><td></td><td></td><td></td><td></td><td></td> </tr> <tr> <td>Pickup Group 3</td> <td></td> <td></td><td></td><td></td><td></td><td></td><td></td><td></td><td></td><td></td><td></td><td></td><td></td><td></td><td></td><td></td><td></td> </tr> <tr> <td>Pickup Group 4</td> <td></td> <td></td><td></td><td></td><td></td><td></td><td></td><td></td><td></td><td></td><td></td><td></td><td></td><td></td><td></td><td></td><td></td> </tr> </tbody> </table>		Default	To make program change																Extensions	all extensions	11	12	13	14	15	16	17	18	19	20	21	22	23	24	25	26	Pickup Group 1	x																	Pickup Group 2																		Pickup Group 3																		Pickup Group 4																	
	Default	To make program change																																																																																																												
Extensions	all extensions	11	12	13	14	15	16	17	18	19	20	21	22	23	24	25	26																																																																																													
Pickup Group 1	x																																																																																																													
Pickup Group 2																																																																																																														
Pickup Group 3																																																																																																														
Pickup Group 4																																																																																																														
Account Code Input Mode	[25]	<p>[NEXT] [NEXT] [SELECT] [MEMORY] [END] ----- OPTION/FORCED ----- until the desired extension number appears</p> <table border="1"> <thead> <tr> <th></th> <th>Default</th> <th colspan="16">To make program change</th> </tr> <tr> <th>Extensions</th> <td>all extensions</td> <td>11</td><td>12</td><td>13</td><td>14</td><td>15</td><td>16</td><td>17</td><td>18</td><td>19</td><td>20</td><td>21</td><td>22</td><td>23</td><td>24</td><td>25</td><td>26</td> </tr> </thead> <tbody> <tr> <td>Option</td> <td>x</td> <td></td><td></td><td></td><td></td><td></td><td></td><td></td><td></td><td></td><td></td><td></td><td></td><td></td><td></td><td></td><td></td> </tr> <tr> <td>Forced</td> <td></td> <td></td><td></td><td></td><td></td><td></td><td></td><td></td><td></td><td></td><td></td><td></td><td></td><td></td><td></td><td></td><td></td> </tr> </tbody> </table>		Default	To make program change																Extensions	all extensions	11	12	13	14	15	16	17	18	19	20	21	22	23	24	25	26	Option	x																	Forced																																																					
	Default	To make program change																																																																																																												
Extensions	all extensions	11	12	13	14	15	16	17	18	19	20	21	22	23	24	25	26																																																																																													
Option	x																																																																																																													
Forced																																																																																																														
Duration Time Count Start Mode	[26]	<p>[NEXT] [SELECT] [MEMORY] [END] ----- INSTANTLY/5S AFTER DIAL/10S AFTER DIAL</p> <table border="1"> <thead> <tr> <th></th> <th>Default</th> <th>To make program change</th> </tr> </thead> <tbody> <tr> <td>Instantly</td> <td></td> <td></td> </tr> <tr> <td>5S after dial</td> <td>x</td> <td></td> </tr> <tr> <td>10S after dial</td> <td></td> <td></td> </tr> </tbody> </table>		Default	To make program change	Instantly			5S after dial	x		10S after dial																																																																																																		
	Default	To make program change																																																																																																												
Instantly																																																																																																														
5S after dial	x																																																																																																													
10S after dial																																																																																																														
SMDR Communication Parameters	[27]	<p>(Carriage return for a new line) [NEXT][SELECT][MEMORY] ----- CR+LF/CR</p> <table border="1"> <thead> <tr> <th></th> <th>Default</th> <th>To make program change</th> </tr> </thead> <tbody> <tr> <td>CR+LF</td> <td>x</td> <td></td> </tr> <tr> <td>CR</td> <td></td> <td></td> </tr> </tbody> </table> <p>(Baud rate) [NEXT][SELECT][MEMORY] ----- 110B/150B/300B/600B/1200B/2400B/4800B/9600B</p> <table border="1"> <thead> <tr> <th></th> <th>110B</th> <th>150B</th> <th>300B</th> <th>600B</th> <th>1200B</th> <th>2400B</th> <th>4800B</th> <th>9600B</th> </tr> </thead> <tbody> <tr> <td>Default</td> <td></td><td></td><td></td><td></td><td>x</td><td></td><td></td><td></td> </tr> <tr> <td>To make program change</td> <td></td><td></td><td></td><td></td><td></td><td></td><td></td><td></td> </tr> </tbody> </table> <p>(Word length) [NEXT][SELECT][MEMORY] ----- 7 BITS/8 BITS</p> <table border="1"> <thead> <tr> <th></th> <th>Default</th> <th>To make program change</th> </tr> </thead> <tbody> <tr> <td>7 BITS</td> <td>x</td> <td></td> </tr> <tr> <td>8 BITS</td> <td></td> <td></td> </tr> </tbody> </table> <p>(Parity) [NEXT][SELECT][MEMORY] ----- NONE/MARK/SPACE/EVEN/ODD</p> <table border="1"> <thead> <tr> <th></th> <th>None</th> <th>Mark</th> <th>Space</th> <th>Even</th> <th>Odd</th> </tr> </thead> <tbody> <tr> <td>Default</td> <td></td><td>x</td><td></td><td></td><td></td> </tr> <tr> <td>To make program change</td> <td></td><td></td><td></td><td></td><td></td> </tr> </tbody> </table>		Default	To make program change	CR+LF	x		CR				110B	150B	300B	600B	1200B	2400B	4800B	9600B	Default					x				To make program change										Default	To make program change	7 BITS	x		8 BITS				None	Mark	Space	Even	Odd	Default		x				To make program change																																																		
	Default	To make program change																																																																																																												
CR+LF	x																																																																																																													
CR																																																																																																														
	110B	150B	300B	600B	1200B	2400B	4800B	9600B																																																																																																						
Default					x																																																																																																									
To make program change																																																																																																														
	Default	To make program change																																																																																																												
7 BITS	x																																																																																																													
8 BITS																																																																																																														
	None	Mark	Space	Even	Odd																																																																																																									
Default		x																																																																																																												
To make program change																																																																																																														

TO SET	PROGRAM ADDRESS	STEPS REQUIRED TO CHANGE PROGRAM																					
SMDR Communication Parameters		<p>(Stop bit length) [NEXT][SELECT][MEMORY] └----- 1 BIT/2 BITS</p> <table border="1" data-bbox="471 449 1208 534"> <thead> <tr> <th></th> <th>Default</th> <th>To make program change</th> </tr> </thead> <tbody> <tr> <td>1 BIT</td> <td>x</td> <td></td> </tr> <tr> <td>2 BITS</td> <td></td> <td></td> </tr> </tbody> </table> <p>(Page length) [NEXT][AB][MEMORY] └----- 4 through 99 lines</p> <table border="1" data-bbox="476 683 1213 740"> <thead> <tr> <th></th> <th>Default</th> <th>To make program change</th> </tr> </thead> <tbody> <tr> <td>Lines per page</td> <td>66</td> <td></td> </tr> </tbody> </table> <p>(Skip perforation) [NEXT][AB][MEMORY][END] └----- 0 through 95 lines</p> <table border="1" data-bbox="479 889 1216 946"> <thead> <tr> <th></th> <th>Default</th> <th>To make program change</th> </tr> </thead> <tbody> <tr> <td>Skipping lines</td> <td>0</td> <td></td> </tr> </tbody> </table>		Default	To make program change	1 BIT	x		2 BITS				Default	To make program change	Lines per page	66			Default	To make program change	Skipping lines	0	
	Default	To make program change																					
1 BIT	x																						
2 BITS																							
	Default	To make program change																					
Lines per page	66																						
	Default	To make program change																					
Skipping lines	0																						
System Data Dump	[28]	<ul style="list-style-type: none"> • SYSTEM PARA • SPEED DIAL • ALL PARA • STOP OUTPUT <p>[NEXT][SELECT][MEMORY][END] └----- SYSTEM PARA/CO PARA/EXT PARA/SPEED DIAL ALL PARA/STOP OUTPUT</p> <ul style="list-style-type: none"> • CO PARA <p>[NEXT][SELECT][MEMORY][A][END] └----- dial CO number └----- until the CO PARA appears</p> <ul style="list-style-type: none"> • EXT PARA <p>[NEXT][SELECT][MEMORY][AB][END] └----- dial extension number └----- until the EXT PARA appears</p>																					
SMDR Incoming/ Outgoing Selection	[29]	<p>[NEXT][SELECT][MEMORY][NEXT][SELECT][MEMORY][END] └----- OUTGOING: ON/OFF └----- INCOMING: ON/OFF</p> <table border="1" data-bbox="489 1755 1229 1868"> <thead> <tr> <th rowspan="2"></th> <th colspan="2">Outgoing</th> <th colspan="2">Incoming</th> </tr> <tr> <th>ON</th> <th>OFF</th> <th>ON</th> <th>OFF</th> </tr> </thead> <tbody> <tr> <td>Default</td> <td>x</td> <td></td> <td>x</td> <td></td> </tr> <tr> <td>To make program change</td> <td></td> <td></td> <td></td> <td></td> </tr> </tbody> </table>		Outgoing		Incoming		ON	OFF	ON	OFF	Default	x		x		To make program change						
	Outgoing			Incoming																			
	ON	OFF	ON	OFF																			
Default	x		x																				
To make program change																							

TO SET	PROGRAM ADDRESS	STEPS REQUIRED TO CHANGE PROGRAM																																								
Hold Time Reminder	[30]	<p>[NEXT] [SELECT] [MEMORY] [END] ----- 1 MIN/2 MIN...../9 MIN</p> <table border="1"> <thead> <tr> <th></th> <th colspan="9">minutes</th> </tr> <tr> <th></th> <th>1</th> <th>2</th> <th>3</th> <th>4</th> <th>5</th> <th>6</th> <th>7</th> <th>8</th> <th>9</th> </tr> </thead> <tbody> <tr> <td>Default</td> <td></td> <td></td> <td>x</td> <td></td> <td></td> <td></td> <td></td> <td></td> <td></td> </tr> <tr> <td>To make program change</td> <td></td> <td></td> <td></td> <td></td> <td></td> <td></td> <td></td> <td></td> <td></td> </tr> </tbody> </table>		minutes										1	2	3	4	5	6	7	8	9	Default			x							To make program change									
	minutes																																									
	1	2	3	4	5	6	7	8	9																																	
Default			x																																							
To make program change																																										
Hold Recall Time Set	[31]	<p>[NEXT] [SELECT] [MEMORY] [END] ----- 30 SEC/1 MIN/1.5 MIN/2 MIN/DISABLE</p> <table border="1"> <thead> <tr> <th></th> <th>30 seconds</th> <th>1 minute</th> <th>1 minute 30 seconds</th> <th>2 minutes</th> <th>disable</th> </tr> </thead> <tbody> <tr> <td>Default</td> <td>x</td> <td></td> <td></td> <td></td> <td></td> </tr> <tr> <td>To make program change</td> <td></td> <td></td> <td></td> <td></td> <td></td> </tr> </tbody> </table>		30 seconds	1 minute	1 minute 30 seconds	2 minutes	disable	Default	x					To make program change																											
	30 seconds	1 minute	1 minute 30 seconds	2 minutes	disable																																					
Default	x																																									
To make program change																																										
Programmable External Paging Access Tone	[32]	<p>[NEXT] [SELECT] [MEMORY] [END] ----- ENABLE/DISABLE</p> <table border="1"> <thead> <tr> <th></th> <th>Default</th> <th>To make program change</th> </tr> </thead> <tbody> <tr> <td>Enable</td> <td>x</td> <td></td> </tr> <tr> <td>Disable</td> <td></td> <td></td> </tr> </tbody> </table>		Default	To make program change	Enable	x		Disable																																	
	Default	To make program change																																								
Enable	x																																									
Disable																																										
Programmable secret Speed Dial	[33]	<p>[NEXT] [SELECT] [MEMORY] [END] ----- NO SECRET/ SECRET</p> <table border="1"> <thead> <tr> <th></th> <th>Default</th> <th>To make program change</th> </tr> </thead> <tbody> <tr> <td>No secret</td> <td>x</td> <td></td> </tr> <tr> <td>Secret</td> <td></td> <td></td> </tr> </tbody> </table>		Default	To make program change	No secret	x		Secret																																	
	Default	To make program change																																								
No secret	x																																									
Secret																																										
Hookswitch Flash Timing	[34]	<p>[NEXT] [NEXT] [SELECT] [MEMORY] [END] ----- 300 MS/600 MS/900 MS ----- until the desired CO number appears</p> <table border="1"> <thead> <tr> <th></th> <th>Default</th> <th colspan="6">To make program change</th> </tr> <tr> <th>CO(s)</th> <th>all CO's</th> <th>1</th> <th>2</th> <th>3</th> <th>4</th> <th>5</th> <th>6</th> </tr> </thead> <tbody> <tr> <td>300 msec</td> <td></td> <td></td> <td></td> <td></td> <td></td> <td></td> <td></td> </tr> <tr> <td>600 msec</td> <td>x</td> <td></td> <td></td> <td></td> <td></td> <td></td> <td></td> </tr> <tr> <td>900 msec</td> <td></td> <td></td> <td></td> <td></td> <td></td> <td></td> <td></td> </tr> </tbody> </table>		Default	To make program change						CO(s)	all CO's	1	2	3	4	5	6	300 msec								600 msec	x							900 msec							
	Default	To make program change																																								
CO(s)	all CO's	1	2	3	4	5	6																																			
300 msec																																										
600 msec	x																																									
900 msec																																										
Disconnect Time	[35]	<p>[NEXT] [NEXT] [SELECT] [MEMORY] [END] ----- 1.5 SEC/4.0 SEC ----- until the desired CO number appears</p> <table border="1"> <thead> <tr> <th></th> <th>Default</th> <th colspan="6">To make program change</th> </tr> <tr> <th>CO(s)</th> <th>all CO's</th> <th>1</th> <th>2</th> <th>3</th> <th>4</th> <th>5</th> <th>6</th> </tr> </thead> <tbody> <tr> <td>1.5 sec</td> <td>x</td> <td></td> <td></td> <td></td> <td></td> <td></td> <td></td> </tr> <tr> <td>4.0 sec</td> <td></td> <td></td> <td></td> <td></td> <td></td> <td></td> <td></td> </tr> </tbody> </table>		Default	To make program change						CO(s)	all CO's	1	2	3	4	5	6	1.5 sec	x							4.0 sec															
	Default	To make program change																																								
CO(s)	all CO's	1	2	3	4	5	6																																			
1.5 sec	x																																									
4.0 sec																																										
Calling Party Control (CPC) Signal	[36]	<p>[NEXT] [NEXT] [SELECT] [MEMORY] [END] ----- ENABLE/DISABLE ----- until the desired CO number appears</p> <table border="1"> <thead> <tr> <th></th> <th>Default</th> <th colspan="6">To make program change</th> </tr> <tr> <th>CO(s)</th> <th>all CO's</th> <th>1</th> <th>2</th> <th>3</th> <th>4</th> <th>5</th> <th>6</th> </tr> </thead> <tbody> <tr> <td>Enable</td> <td>x</td> <td></td> <td></td> <td></td> <td></td> <td></td> <td></td> </tr> <tr> <td>Disable</td> <td></td> <td></td> <td></td> <td></td> <td></td> <td></td> <td></td> </tr> </tbody> </table>		Default	To make program change						CO(s)	all CO's	1	2	3	4	5	6	Enable	x							Disable															
	Default	To make program change																																								
CO(s)	all CO's	1	2	3	4	5	6																																			
Enable	x																																									
Disable																																										

TO SET	PROGRAM ADDRESS	STEPS REQUIRED TO CHANGE PROGRAM																																																																								
DSS Button Mode	[37]	<p>[NEXT] [SELECT] [MEMORY] [END] ----- WITHOUT TRANSFER/WITH TRANSFER</p> <table border="1"> <thead> <tr> <th></th> <th>Default</th> <th colspan="2">To make program change</th> </tr> </thead> <tbody> <tr> <td>Without transfer</td> <td>×</td> <td></td> <td></td> </tr> <tr> <td>With transfer</td> <td></td> <td></td> <td></td> </tr> </tbody> </table>		Default	To make program change		Without transfer	×			With transfer																																																															
	Default	To make program change																																																																								
Without transfer	×																																																																									
With transfer																																																																										
DTMF Receiver Check	[38]	<p>[NEXT] [SELECT] [MEMORY] [END] ----- ENABLE/DISABLE --- until the desired DTMF receiver appears</p> <table border="1"> <thead> <tr> <th></th> <th>Default</th> <th colspan="2">To make program change</th> </tr> </thead> <tbody> <tr> <td>DTMF receiver</td> <td>1, 2</td> <td>1</td> <td>2</td> </tr> <tr> <td>Enable</td> <td>×</td> <td></td> <td></td> </tr> <tr> <td>Disable</td> <td></td> <td></td> <td></td> </tr> </tbody> </table>		Default	To make program change		DTMF receiver	1, 2	1	2	Enable	×			Disable																																																											
	Default	To make program change																																																																								
DTMF receiver	1, 2	1	2																																																																							
Enable	×																																																																									
Disable																																																																										
Transfer Recall Time	[39]	<p>[NEXT] [SELECT] [MEMORY] [END] ----- 30 SEC/2 MIN</p> <table border="1"> <thead> <tr> <th></th> <th>Default</th> <th colspan="2">To make program change</th> </tr> </thead> <tbody> <tr> <td>30 sec</td> <td>×</td> <td></td> <td></td> </tr> <tr> <td>2 min</td> <td></td> <td></td> <td></td> </tr> </tbody> </table>		Default	To make program change		30 sec	×			2 min																																																															
	Default	To make program change																																																																								
30 sec	×																																																																									
2 min																																																																										
M3/FWD Selection	[40]	<p>[NEXT][NEXT][SELECT][MEMORY][END] ----- FEATURE KEY/FWD, DND KEY --- until the desired extension number appears</p> <table border="1"> <thead> <tr> <th></th> <th>Default</th> <th colspan="16">To make program change</th> </tr> </thead> <tbody> <tr> <td>Extensions</td> <td>all extensions</td> <td>11</td><td>12</td><td>13</td><td>14</td><td>15</td><td>16</td><td>17</td><td>18</td><td>19</td><td>20</td><td>21</td><td>22</td><td>23</td><td>24</td><td>25</td><td>26</td> </tr> <tr> <td>Feature key</td> <td>×</td> <td></td><td></td><td></td><td></td><td></td><td></td><td></td><td></td><td></td><td></td><td></td><td></td><td></td><td></td><td></td><td></td> </tr> <tr> <td>FWD/DND key</td> <td></td> <td></td><td></td><td></td><td></td><td></td><td></td><td></td><td></td><td></td><td></td><td></td><td></td><td></td><td></td><td></td><td></td> </tr> </tbody> </table>		Default	To make program change																Extensions	all extensions	11	12	13	14	15	16	17	18	19	20	21	22	23	24	25	26	Feature key	×																	FWD/DND key																	
	Default	To make program change																																																																								
Extensions	all extensions	11	12	13	14	15	16	17	18	19	20	21	22	23	24	25	26																																																									
Feature key	×																																																																									
FWD/DND key																																																																										
Station Program Clear	[98]	[NEXT][MEMORY][END]																																																																								
System Clear	[99]	[NEXT][MEMORY][END]																																																																								

TO MAKE CALLS

- Inter office calling: extension no.
- Outward dialing
 - Automatic line access: 9 phone no.
 - Individual line access: 8 CO no. phone no.
- Speed dialing: * speed access no.
(A rotary phone will not function this mode.)
- Calling doorphone
For doorphone 1: 3 1
For doorphone 2: 3 2

WHEN A LINE IS BUSY

- Automatic call back busy: 6
- Busy station signaling: 1
- Last number redial: # or 8 0

TO RECEIVE CALLS

- Dial call pickup: 4 0
- Directed call pickup: 4 extension no.
- Call park retrieve: 5 extension no.

WHILE HAVING A CONVERSATION

- Call on hold: Flash hookswitch
- Call splitting: Flash hookswitch
- Conference: Consult with 2nd party while 1st party is on hold
Flash hookswitch 3
- Call waiting: Flash hookswitch Hang up
Lift handset
- Call transfer: Flash hookswitch extension no.

TO MAKE CALLS

- Inter office calling: extension no.
- Outward dialing
 - Automatic line access: 9 phone no.
 - Individual line access: 8 CO no. phone no.
- Speed dialing: * speed access no.
(A rotary phone will not function this mode.)
- Calling doorphone
For doorphone 1: 3 1
For doorphone 2: 3 2

WHEN A LINE IS BUSY

- Automatic call back busy: 6
- Busy station signaling: 1
- Last number redial: # or 8 0

TO RECEIVE CALLS

- Dial call pickup: 4 0
- Directed call pickup: 4 extension no.
- Call park retrieve: 5 extension no.

WHILE HAVING A CONVERSATION

- Call on hold: Flash hookswitch
- Call splitting: Flash hookswitch
- Conference: Consult with 2nd party while 1st party is on hold
Flash hookswitch 3
- Call waiting: Flash hookswitch Hang up
Lift handset
- Call transfer: Flash hookswitch extension no.

Detach this position

TO MAKE CALLS

- Inter office calling: extension no.
- Outward dialing
 - Automatic line access: 9 phone no.
 - Individual line access: 8 CO no. phone no.
- Speed dialing: * speed access no.
(A rotary phone will not function this mode.)
- Calling doorphone
For doorphone 1: 3 1
For doorphone 2: 3 2

WHEN A LINE IS BUSY

- Automatic call back busy: 6
- Busy station signaling: 1
- Last number redial: # or 8 0

TO RECEIVE CALLS

- Dial call pickup: 4 0
- Directed call pickup: 4 extension no.
- Call park retrieve: 5 extension no.

WHILE HAVING A CONVERSATION

- Call on hold: Flash hookswitch
- Call splitting: Flash hookswitch
- Conference: Consult with 2nd party while 1st party is on hold
Flash hookswitch 3
- Call waiting: Flash hookswitch Hang up
Lift handset
- Call transfer: Flash hookswitch extension no.

TO MAKE CALLS

- Inter office calling: extension no.
- Outward dialing
 - Automatic line access: 9 phone no.
 - Individual line access: 8 CO no. phone no.
- Speed dialing: * speed access no.
(A rotary phone will not function this mode.)
- Calling doorphone
For doorphone 1: 3 1
For doorphone 2: 3 2

WHEN A LINE IS BUSY

- Automatic call back busy: 6
- Busy station signaling: 1
- Last number redial: # or 8 0

TO RECEIVE CALLS

- Dial call pickup: 4 0
- Directed call pickup: 4 extension no.
- Call park retrieve: 5 extension no.

WHILE HAVING A CONVERSATION

- Call on hold: Flash hookswitch
- Call splitting: Flash hookswitch
- Conference: Consult with 2nd party while 1st party is on hold
Flash hookswitch 3
- Call waiting: Flash hookswitch Hang up
Lift handset
- Call transfer: Flash hookswitch extension no.

USE OF OTHER FEATURES

- Paging all extensions:
 - Paging group:
 - Paging-external:
 - Paging answer:
 - External feature access:
 - Intercom alerting mode:
- (A rotary phone will not function this mode.)

STATION PROGRAMMING

You may dial "0" instead of pressing the "#" button.

- Call forwarding
 - Setting:
 - To cancel:
- Dial call pickup deny
 - Setting:
 - To cancel:
- Do not disturb
 - Setting:
 - To cancel:
- Data line security
 - Setting:
 - To cancel:
- Station programming clear:

USE OF OTHER FEATURES

- Paging all extensions:
 - Paging group:
 - Paging-external:
 - Paging answer:
 - External feature access:
 - Intercom alerting mode:
- (A rotary phone will not function this mode.)

STATION PROGRAMMING

You may dial "0" instead of pressing the "#" button.

- Call forwarding
 - Setting:
 - To cancel:
- Dial call pickup deny
 - Setting:
 - To cancel:
- Do not disturb
 - Setting:
 - To cancel:
- Data line security
 - Setting:
 - To cancel:
- Station programming clear:

USE OF OTHER FEATURES

- Paging all extensions:
 - Paging group:
 - Paging-external:
 - Paging answer:
 - External feature access:
 - Intercom alerting mode:
- (A rotary phone will not function this mode.)

STATION PROGRAMMING

You may dial "0" instead of pressing the "#" button.

- Call forwarding
 - Setting:
 - To cancel:
- Dial call pickup deny
 - Setting:
 - To cancel:
- Do not disturb
 - Setting:
 - To cancel:
- Data line security
 - Setting:
 - To cancel:
- Station programming clear:

USE OF OTHER FEATURES

- Paging all extensions:
 - Paging group:
 - Paging-external:
 - Paging answer:
 - External feature access:
 - Intercom alerting mode:
- (A rotary phone will not function this mode.)

STATION PROGRAMMING

You may dial "0" instead of pressing the "#" button.

- Call forwarding
 - Setting:
 - To cancel:
- Dial call pickup deny
 - Setting:
 - To cancel:
- Do not disturb
 - Setting:
 - To cancel:
- Data line security
 - Setting:
 - To cancel:
- Station programming clear:

TO MAKE CALLS

- Inter office calling: extension no.
- Outward dialing
 - Automatic line access: 9 phone no.
 - Individual line access: 8 CO no. phone no.
- Speed dialing: * speed access no.
(A rotary phone will not function this mode.)
- Calling doorphone
For doorphone 1: 3 1
For doorphone 2: 3 2

WHEN A LINE IS BUSY

- Automatic call back busy: 6
- Busy station signaling: 1
- Last number redial: # or 8 0

TO RECEIVE CALLS

- Dial call pickup: 4 0
- Directed call pickup: 4 extension no.
- Call park retrieve: 5 extension no.

WHILE HAVING A CONVERSATION

- Call on hold: Flash hookswitch
- Call splitting: Flash hookswitch
- Conference: Consult with 2nd party while 1st party is on hold
Flash hookswitch 3
- Call waiting: Flash hookswitch Hang up
Lift handset
- Call transfer: Flash hookswitch extension no.

TO MAKE CALLS

- Inter office calling: extension no.
- Outward dialing
 - Automatic line access: 9 phone no.
 - Individual line access: 8 CO no. phone no.
- Speed dialing: * speed access no.
(A rotary phone will not function this mode.)
- Calling doorphone
For doorphone 1: 3 1
For doorphone 2: 3 2

WHEN A LINE IS BUSY

- Automatic call back busy: 6
- Busy station signaling: 1
- Last number redial: # or 8 0

TO RECEIVE CALLS

- Dial call pickup: 4 0
- Directed call pickup: 4 extension no.
- Call park retrieve: 5 extension no.

WHILE HAVING A CONVERSATION

- Call on hold: Flash hookswitch
- Call splitting: Flash hookswitch
- Conference: Consult with 2nd party while 1st party is on hold
Flash hookswitch 3
- Call waiting: Flash hookswitch Hang up
Lift handset
- Call transfer: Flash hookswitch extension no.

Detach this position

TO MAKE CALLS

- Inter office calling: extension no.
- Outward dialing
 - Automatic line access: 9 phone no.
 - Individual line access: 8 CO no. phone no.
- Speed dialing: * speed access no.
(A rotary phone will not function this mode.)
- Calling doorphone
For doorphone 1: 3 1
For doorphone 2: 3 2

WHEN A LINE IS BUSY

- Automatic call back busy: 6
- Busy station signaling: 1
- Last number redial: # or 8 0

TO RECEIVE CALLS

- Dial call pickup: 4 0
- Directed call pickup: 4 extension no.
- Call park retrieve: 5 extension no.

WHILE HAVING A CONVERSATION

- Call on hold: Flash hookswitch
- Call splitting: Flash hookswitch
- Conference: Consult with 2nd party while 1st party is on hold
Flash hookswitch 3
- Call waiting: Flash hookswitch Hang up
Lift handset
- Call transfer: Flash hookswitch extension no.

TO MAKE CALLS

- Inter office calling: extension no.
- Outward dialing
 - Automatic line access: 9 phone no.
 - Individual line access: 8 CO no. phone no.
- Speed dialing: * speed access no.
(A rotary phone will not function this mode.)
- Calling doorphone
For doorphone 1: 3 1
For doorphone 2: 3 2

WHEN A LINE IS BUSY

- Automatic call back busy: 6
- Busy station signaling: 1
- Last number redial: # or 8 0

TO RECEIVE CALLS

- Dial call pickup: 4 0
- Directed call pickup: 4 extension no.
- Call park retrieve: 5 extension no.

WHILE HAVING A CONVERSATION

- Call on hold: Flash hookswitch
- Call splitting: Flash hookswitch
- Conference: Consult with 2nd party while 1st party is on hold
Flash hookswitch 3
- Call waiting: Flash hookswitch Hang up
Lift handset
- Call transfer: Flash hookswitch extension no.

USE OF OTHER FEATURES

- Paging all extensions: 3 4
 - Paging group: 3 5
 - Paging-external: 3 3
 - Paging answer: 4 3
 - External feature access: Flash hookswitch 0
 - Intercom alerting mode: Hear 1 beep *
- (A rotary phone will not function this mode.)

STATION PROGRAMMING

You may dial "0" instead of pressing the "#" button.

- Call forwarding
 - Setting: 7 1 extension no. #
 - To cancel: 7 0 #
- Dial call pickup deny
 - Setting: 7 3 1 #
 - To cancel: 7 3 0 #
- Do not disturb
 - Setting: 7 1 1 0 #
 - To cancel: 7 0 #
- Data line security
 - Setting: 7 4 1 #
 - To cancel: 7 4 0 #
- Station programming clear: 7 9 #

USE OF OTHER FEATURES

- Paging all extensions: 3 4
 - Paging group: 3 5
 - Paging-external: 3 3
 - Paging answer: 4 3
 - External feature access: Flash hookswitch 0
 - Intercom alerting mode: Hear 1 beep *
- (A rotary phone will not function this mode.)

STATION PROGRAMMING

You may dial "0" instead of pressing the "#" button.

- Call forwarding
 - Setting: 7 1 extension no. #
 - To cancel: 7 0 #
- Dial call pickup deny
 - Setting: 7 3 1 #
 - To cancel: 7 3 0 #
- Do not disturb
 - Setting: 7 1 1 0 #
 - To cancel: 7 0 #
- Data line security
 - Setting: 7 4 1 #
 - To cancel: 7 4 0 #
- Station programming clear: 7 9 #

USE OF OTHER FEATURES

- Paging all extensions: 3 4
 - Paging group: 3 5
 - Paging-external: 3 3
 - Paging answer: 4 3
 - External feature access: Flash hookswitch 0
 - Intercom alerting mode: Hear 1 beep *
- (A rotary phone will not function this mode.)

STATION PROGRAMMING

You may dial "0" instead of pressing the "#" button.

- Call forwarding
 - Setting: 7 1 extension no. #
 - To cancel: 7 0 #
- Dial call pickup deny
 - Setting: 7 3 1 #
 - To cancel: 7 3 0 #
- Do not disturb
 - Setting: 7 1 1 0 #
 - To cancel: 7 0 #
- Data line security
 - Setting: 7 4 1 #
 - To cancel: 7 4 0 #
- Station programming clear: 7 9 #

USE OF OTHER FEATURES

- Paging all extensions: 3 4
 - Paging group: 3 5
 - Paging-external: 3 3
 - Paging answer: 4 3
 - External feature access: Flash hookswitch 0
 - Intercom alerting mode: Hear 1 beep *
- (A rotary phone will not function this mode.)

STATION PROGRAMMING

You may dial "0" instead of pressing the "#" button.

- Call forwarding
 - Setting: 7 1 extension no. #
 - To cancel: 7 0 #
- Dial call pickup deny
 - Setting: 7 3 1 #
 - To cancel: 7 3 0 #
- Do not disturb
 - Setting: 7 1 1 0 #
 - To cancel: 7 0 #
- Data line security
 - Setting: 7 4 1 #
 - To cancel: 7 4 0 #
- Station programming clear: 7 9 #

TO MAKE CALLS

- Inter office calling: extension no.
- Outward dialing
 - Automatic line access: 9 phone no.
 - Individual line access: 8 CO no. phone no.
- Speed dialing: * speed access no.
(A rotary phone will not function this mode.)
- Calling doorphone
For doorphone 1: 3 1
For doorphone 2: 3 2

WHEN A LINE IS BUSY

- Automatic call back busy: 6
- Busy station signaling: 1
- Last number redial: # or 8 0

TO RECEIVE CALLS

- Dial call pickup: 4 0
- Directed call pickup: 4 extension no.
- Call park retrieve: 5 extension no.

WHILE HAVING A CONVERSATION

- Call on hold: Flash hookswitch
- Call splitting: Flash hookswitch
- Conference: Consult with 2nd party while 1st party is on hold
Flash hookswitch 3
- Call waiting: Flash hookswitch Hang up
Lift handset
- Call transfer: Flash hookswitch extension no.

TO MAKE CALLS

- Inter office calling: extension no.
- Outward dialing
 - Automatic line access: 9 phone no.
 - Individual line access: 8 CO no. phone no.
- Speed dialing: * speed access no.
(A rotary phone will not function this mode.)
- Calling doorphone
For doorphone 1: 3 1
For doorphone 2: 3 2

WHEN A LINE IS BUSY

- Automatic call back busy: 6
- Busy station signaling: 1
- Last number redial: # or 8 0

TO RECEIVE CALLS

- Dial call pickup: 4 0
- Directed call pickup: 4 extension no.
- Call park retrieve: 5 extension no.

WHILE HAVING A CONVERSATION

- Call on hold: Flash hookswitch
- Call splitting: Flash hookswitch
- Conference: Consult with 2nd party while 1st party is on hold
Flash hookswitch 3
- Call waiting: Flash hookswitch Hang up
Lift handset
- Call transfer: Flash hookswitch extension no.

TO MAKE CALLS

- Inter office calling: extension no.
- Outward dialing
 - Automatic line access: 9 phone no.
 - Individual line access: 8 CO no. phone no.
- Speed dialing: * speed access no.
(A rotary phone will not function this mode.)
- Calling doorphone
For doorphone 1: 3 1
For doorphone 2: 3 2

WHEN A LINE IS BUSY

- Automatic call back busy: 6
- Busy station signaling: 1
- Last number redial: # or 8 0

TO RECEIVE CALLS

- Dial call pickup: 4 0
- Directed call pickup: 4 extension no.
- Call park retrieve: 5 extension no.

WHILE HAVING A CONVERSATION

- Call on hold: Flash hookswitch
- Call splitting: Flash hookswitch
- Conference: Consult with 2nd party while 1st party is on hold
Flash hookswitch 3
- Call waiting: Flash hookswitch Hang up
Lift handset
- Call transfer: Flash hookswitch extension no.

TO MAKE CALLS

- Inter office calling: extension no.
- Outward dialing
 - Automatic line access: 9 phone no.
 - Individual line access: 8 CO no. phone no.
- Speed dialing: * speed access no.
(A rotary phone will not function this mode.)
- Calling doorphone
For doorphone 1: 3 1
For doorphone 2: 3 2

WHEN A LINE IS BUSY

- Automatic call back busy: 6
- Busy station signaling: 1
- Last number redial: # or 8 0

TO RECEIVE CALLS

- Dial call pickup: 4 0
- Directed call pickup: 4 extension no.
- Call park retrieve: 5 extension no.

WHILE HAVING A CONVERSATION

- Call on hold: Flash hookswitch
- Call splitting: Flash hookswitch
- Conference: Consult with 2nd party while 1st party is on hold
Flash hookswitch 3
- Call waiting: Flash hookswitch Hang up
Lift handset
- Call transfer: Flash hookswitch extension no.

USE OF OTHER FEATURES

- Paging all extensions: 3 4
- Paging group: 3 5
- Paging-external: 3 3
- Paging answer: 4 3
- External feature access: Flash hookswitch 0
- Intercom alerting mode: Hear 1 beep ✕

(A rotary phone will not function this mode.)

STATION PROGRAMMING

You may dial "0" instead of pressing the "#" button.

- Call forwarding
 - Setting: 7 1 extension no. #
 - To cancel: 7 0 #
- Dial call pickup deny
 - Setting: 7 3 1 #
 - To cancel: 7 3 0 #
- Do not disturb
 - Setting: 7 1 1 0 #
 - To cancel: 7 0 #
- Data line security
 - Setting: 7 4 1 #
 - To cancel: 7 4 0 #
- Station programming clear: 7 9 #

USE OF OTHER FEATURES

- Paging all extensions: 3 4
- Paging group: 3 5
- Paging-external: 3 3
- Paging answer: 4 3
- External feature access: Flash hookswitch 0
- Intercom alerting mode: Hear 1 beep ✕

(A rotary phone will not function this mode.)

STATION PROGRAMMING

You may dial "0" instead of pressing the "#" button.

- Call forwarding
 - Setting: 7 1 extension no. #
 - To cancel: 7 0 #
- Dial call pickup deny
 - Setting: 7 3 1 #
 - To cancel: 7 3 0 #
- Do not disturb
 - Setting: 7 1 1 0 #
 - To cancel: 7 0 #
- Data line security
 - Setting: 7 4 1 #
 - To cancel: 7 4 0 #
- Station programming clear: 7 9 #

USE OF OTHER FEATURES

- Paging all extensions: 3 4
- Paging group: 3 5
- Paging-external: 3 3
- Paging answer: 4 3
- External feature access: Flash hookswitch 0
- Intercom alerting mode: Hear 1 beep ✕

(A rotary phone will not function this mode.)

STATION PROGRAMMING

You may dial "0" instead of pressing the "#" button.

- Call forwarding
 - Setting: 7 1 extension no. #
 - To cancel: 7 0 #
- Dial call pickup deny
 - Setting: 7 3 1 #
 - To cancel: 7 3 0 #
- Do not disturb
 - Setting: 7 1 1 0 #
 - To cancel: 7 0 #
- Data line security
 - Setting: 7 4 1 #
 - To cancel: 7 4 0 #
- Station programming clear: 7 9 #

USE OF OTHER FEATURES

- Paging all extensions: 3 4
- Paging group: 3 5
- Paging-external: 3 3
- Paging answer: 4 3
- External feature access: Flash hookswitch 0
- Intercom alerting mode: Hear 1 beep ✕

(A rotary phone will not function this mode.)

STATION PROGRAMMING

You may dial "0" instead of pressing the "#" button.

- Call forwarding
 - Setting: 7 1 extension no. #
 - To cancel: 7 0 #
- Dial call pickup deny
 - Setting: 7 3 1 #
 - To cancel: 7 3 0 #
- Do not disturb
 - Setting: 7 1 1 0 #
 - To cancel: 7 0 #
- Data line security
 - Setting: 7 4 1 #
 - To cancel: 7 4 0 #
- Station programming clear: 7 9 #

Detach this position

Quick Reference Card for Standard Telephone

TO MAKE CALLS

- Inter office calling: [extension no.]
- Outward dialing
 - Automatic line access: 9 [phone no.]
 - Individual line access: 8 [CO no.] [phone no.]
- Speed dialing: * [speed access no.]
(A rotary phone will not function this mode.)
- Calling doorphone
For doorphone 1: 3 1
For doorphone 2: 3 2

WHEN A LINE IS BUSY

- Automatic call back busy: 6
- Busy station signaling: 1
- Last number redial: # or 8 0

TO RECEIVE CALLS

- Dial call pickup: 4 0
- Directed call pickup: 4 [extension no.]
- Call park retrieve: 5 [extension no.]

WHILE HAVING A CONVERSATION

- Call on hold: Flash hookswitch
- Call splitting: Flash hookswitch
- Conference: Consult with 2nd party while 1st party is on hold
Flash hookswitch 3
- Call waiting: Flash hookswitch Hang up
Lift handset
- Call transfer: Flash hookswitch [extension no.]

Quick Reference Card for Standard Telephone

TO MAKE CALLS

- Inter office calling: [extension no.]
- Outward dialing
 - Automatic line access: 9 [phone no.]
 - Individual line access: 8 [CO no.] [phone no.]
- Speed dialing: * [speed access no.]
(A rotary phone will not function this mode.)
- Calling doorphone
For doorphone 1: 3 1
For doorphone 2: 3 2

WHEN A LINE IS BUSY

- Automatic call back busy: 6
- Busy station signaling: 1
- Last number redial: # or 8 0

TO RECEIVE CALLS

- Dial call pickup: 4 0
- Directed call pickup: 4 [extension no.]
- Call park retrieve: 5 [extension no.]

WHILE HAVING A CONVERSATION

- Call on hold: Flash hookswitch
- Call splitting: Flash hookswitch
- Conference: Consult with 2nd party while 1st party is on hold
Flash hookswitch 3
- Call waiting: Flash hookswitch Hang up
Lift handset
- Call transfer: Flash hookswitch [extension no.]

Quick Reference Card for Standard Telephone

TO MAKE CALLS

- Inter office calling: [extension no.]
- Outward dialing
 - Automatic line access: 9 [phone no.]
 - Individual line access: 8 [CO no.] [phone no.]
- Speed dialing: * [speed access no.]
(A rotary phone will not function this mode.)
- Calling doorphone
For doorphone 1: 3 1
For doorphone 2: 3 2

WHEN A LINE IS BUSY

- Automatic call back busy: 6
- Busy station signaling: 1
- Last number redial: # or 8 0

TO RECEIVE CALLS

- Dial call pickup: 4 0
- Directed call pickup: 4 [extension no.]
- Call park retrieve: 5 [extension no.]

WHILE HAVING A CONVERSATION

- Call on hold: Flash hookswitch
- Call splitting: Flash hookswitch
- Conference: Consult with 2nd party while 1st party is on hold
Flash hookswitch 3
- Call waiting: Flash hookswitch Hang up
Lift handset
- Call transfer: Flash hookswitch [extension no.]

Quick Reference Card for Standard Telephone

TO MAKE CALLS

- Inter office calling: [extension no.]
- Outward dialing
 - Automatic line access: 9 [phone no.]
 - Individual line access: 8 [CO no.] [phone no.]
- Speed dialing: * [speed access no.]
(A rotary phone will not function this mode.)
- Calling doorphone
For doorphone 1: 3 1
For doorphone 2: 3 2

WHEN A LINE IS BUSY

- Automatic call back busy: 6
- Busy station signaling: 1
- Last number redial: # or 8 0

TO RECEIVE CALLS

- Dial call pickup: 4 0
- Directed call pickup: 4 [extension no.]
- Call park retrieve: 5 [extension no.]

WHILE HAVING A CONVERSATION

- Call on hold: Flash hookswitch
- Call splitting: Flash hookswitch
- Conference: Consult with 2nd party while 1st party is on hold
Flash hookswitch 3
- Call waiting: Flash hookswitch Hang up
Lift handset
- Call transfer: Flash hookswitch [extension no.]



USE OF OTHER FEATURES

- Paging all extensions: 3 4
 - Paging group: 3 5
 - Paging-external: 3 3
 - Paging answer: 4 3
 - External feature access: Flash hookswitch 0
 - Intercom alerting mode: Hear 1 beep *
- (A rotary phone will not function this mode.)

STATION PROGRAMMING

You may dial "0" instead of pressing the "#" button.

- Call forwarding
 - Setting: 7 1 extension no. #
 - To cancel: 7 0 #
- Dial call pickup deny
 - Setting: 7 3 1 #
 - To cancel: 7 3 0 #
- Do not disturb
 - Setting: 7 1 1 0 #
 - To cancel: 7 0 #
- Data line security
 - Setting: 7 4 1 #
 - To cancel: 7 4 0 #
- Station programming clear: 7 9 #

USE OF OTHER FEATURES

- Paging all extensions: 3 4
 - Paging group: 3 5
 - Paging-external: 3 3
 - Paging answer: 4 3
 - External feature access: Flash hookswitch 0
 - Intercom alerting mode: Hear 1 beep *
- (A rotary phone will not function this mode.)

STATION PROGRAMMING

You may dial "0" instead of pressing the "#" button.

- Call forwarding
 - Setting: 7 1 extension no. #
 - To cancel: 7 0 #
- Dial call pickup deny
 - Setting: 7 3 1 #
 - To cancel: 7 3 0 #
- Do not disturb
 - Setting: 7 1 1 0 #
 - To cancel: 7 0 #
- Data line security
 - Setting: 7 4 1 #
 - To cancel: 7 4 0 #
- Station programming clear: 7 9 #

Detach this position

USE OF OTHER FEATURES

- Paging all extensions: 3 4
 - Paging group: 3 5
 - Paging-external: 3 3
 - Paging answer: 4 3
 - External feature access: Flash hookswitch 0
 - Intercom alerting mode: Hear 1 beep *
- (A rotary phone will not function this mode.)

STATION PROGRAMMING

You may dial "0" instead of pressing the "#" button.

- Call forwarding
 - Setting: 7 1 extension no. #
 - To cancel: 7 0 #
- Dial call pickup deny
 - Setting: 7 3 1 #
 - To cancel: 7 3 0 #
- Do not disturb
 - Setting: 7 1 1 0 #
 - To cancel: 7 0 #
- Data line security
 - Setting: 7 4 1 #
 - To cancel: 7 4 0 #
- Station programming clear: 7 9 #

USE OF OTHER FEATURES

- Paging all extensions: 3 4
 - Paging group: 3 5
 - Paging-external: 3 3
 - Paging answer: 4 3
 - External feature access: Flash hookswitch 0
 - Intercom alerting mode: Hear 1 beep *
- (A rotary phone will not function this mode.)

STATION PROGRAMMING

You may dial "0" instead of pressing the "#" button.

- Call forwarding
 - Setting: 7 1 extension no. #
 - To cancel: 7 0 #
- Dial call pickup deny
 - Setting: 7 3 1 #
 - To cancel: 7 3 0 #
- Do not disturb
 - Setting: 7 1 1 0 #
 - To cancel: 7 0 #
- Data line security
 - Setting: 7 4 1 #
 - To cancel: 7 4 0 #
- Station programming clear: 7 9 #



ELECTRONIC MODULAR SWITCHING SYSTEM
KX-T61610

**Installation and Operation Manual
for Added and Changed Features**

Please read this Manual first and then another Installation Manual for programming.

This manual is available for KX-T61610 which has
the mark 3 on the plate as shown below.

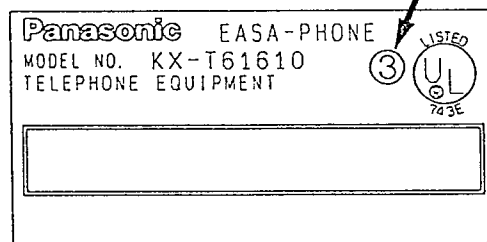

Note:

1. For KX-T7020, 7030, 7050 and 7130, press the "STORE" key instead of "MEMORY" key.
2. For KX-T7020, 7030, 7050 and 7130, press the "AUTO ANSWER" key instead of "AUTO ANS" key.
3. For the Features of Flexible keys, refer to this manual.
4. Extension 11 should be connected to KX-T61630, 30830, 7030 and 7130 for programming system data.
5. All the programming procedures described in the Installation Manual have been modified. Delete step 2 "Press the NEXT button" from every feature of the programming in another Installation Manual. For further detail, see page 3 of this manual. This manual describes the revised procedures from which step 2 has already been deleted.

System Component

	<i>Model No.</i>	<i>Description</i>
<i>Service unit</i>	<i>KX-T61610</i>	<i>Electronic Modular Switching System</i>
<i>Telephone</i>	<i>KX-T61620</i>	<i>EMSS Proprietary Telephone</i>
	<i>KX-T61630</i>	<i>EMSS Proprietary Telephone with LCD</i>
	<i>KX-T61650</i>	<i>EMSS Proprietary Telephone</i>
	<i>KX-T30820</i>	<i>EMSS Proprietary Telephone</i>
	<i>KX-T30830</i>	<i>EMSS Proprietary Telephone with LCD</i>
	<i>KX-T30850</i>	<i>EMSS Proprietary Telephone</i>
	<i>KX-T7020</i>	<i>EMSS Proprietary Telephone</i>
	<i>KX-T7030</i>	<i>EMSS Proprietary Telephone with LCD</i>
	<i>KX-T7050</i>	<i>EMSS Proprietary Telephone</i>
<i>Optional equipment</i>	<i>KX-T61640</i>	<i>DSS Console</i>
	<i>KX-T7040</i>	<i>DSS Console</i>
	<i>KX-T30860D</i>	<i>Doorphone Adaptor</i>
	<i>KX-T30865</i>	<i>Doorphone</i>
	<i>KX-T30866</i>	<i>Door Opener Adaptor</i>
	<i>KX-T30890</i>	<i>Headset</i>
	<i>KX-A16</i>	<i>System Back-up Unit</i>

TABLE OF CONTENTS

<i>Example of Programming</i>	3
Added Features	
<i><Connection></i>	
<i>The Parallel Connection of the Proprietary Telephone and the Standard Telephone</i>	6
<i>Connection of the Optional Door Opener Adaptor (KX-T30866)</i>	7
<i><Program></i>	
<i>Standard Telephone Connection with Proprietary Telephone</i>	8
<i>FI/SAVE Selection (for KX-T61650, KX-T30850, KX-T7020, KX-T7030, KX-T7050)</i>	9
<i>Programmable Executive Override</i>	10
<i>Automatic Designated CO Line Access</i>	11
<i>Programmable Call Waiting Tone</i>	12
<i>Door Opener Assignment</i>	13
<i>Carrier Codes Assignment</i>	14
<i><Detailed Features></i>	
<i>Automatic Redial</i>	15
<i>Flexible CO Button</i>	15
<i>Flexible MESSAGE (Message Waiting) Button (for KX-T7020, KX-T7030, KX-T7050, KX-T7130)</i>	17
<i>Flexible DSS Button (for KX-T30830)</i>	18
<i>Flexible DSS Button (for DSS Console KX-T61640, KX-T7040)</i>	19
<i>Executive Override</i>	20
<i>Door Opener</i>	21
<i>Electronic Station Lock</i>	22
Changed Features	
<i><Program></i>	
<i>Revision List</i>	24
<i>System Speed Dialing—Class Assignment</i>	26
<i>Toll Restriction—Class Assignment</i>	27
<i>Toll Restriction—Denied Code Assignment</i>	29
<i>Toll Restriction—Exceptional Code Assignment</i>	30
<i>System Data Dump</i>	31
<i>Station Message Detail Recording (SMDR) Incoming/Outgoing Selection</i>	33
<i>Hold Recall Time Set</i>	34
Canceled Features	
<i>Cancellation List</i>	35
<i>Programming Table</i>	36

Example of Programming

All the programming procedures described in the Installation Manual have been modified. Delete step 2; "Press the NEXT button" from every feature of the programming in another Installation Manual. See the example below—the portion that should be deleted is shown shaded. This manual describes the revised procedures from which step 2 has already been deleted, as "Revision" below.

Original	Revision
<ol style="list-style-type: none"> 1. Dial (01) or press the AUTO button to go into the speed dialing entry mode. "SPEED DIALING" will be displayed. 2. Press the NEXT button. "ENTER SPEED CODE" will be displayed. 3. Dial (00 through 99) or press the NEXT button, for speed access code entry. 4. Enter the line access number. 5. Enter the phone number. 6. Press the MEMORY button. The memory indicator will be lit. 7. To program desired speed access code, press the SELECT button and then dial the speed access code. To advance to the next speed access code, press the NEXT button. To return to the previous speed access code, press the PREV button. 8. Repeat steps 4 to 7. 9. To exit from speed dialing entry, press the END button. 	<ol style="list-style-type: none"> 1. Dial (01) or press the AUTO button to go into the speed dialing entry mode. "ENTER SPEED CODE" will be displayed. 2. Dial (00 through 99) or press the NEXT button, for speed access code entry. 3. Enter the line access number. 4. Enter the phone number. 5. Press the MEMORY button. The memory indicator will be lit. 6. To program desired speed access code, press the SELECT button and then dial the speed access code. To advance to the next speed access code, press the NEXT button. To return to the previous speed access code, press the PREV button. 7. Repeat steps 3 to 6. 8. To exit from speed dialing entry, press the END button.

When the System Program Switch on the KX-T61610 is set to the PROGRAM position, the operation of the KX-T7030 and the KX-T7130 connected to extension 11 will change as follows.

KX-T7030

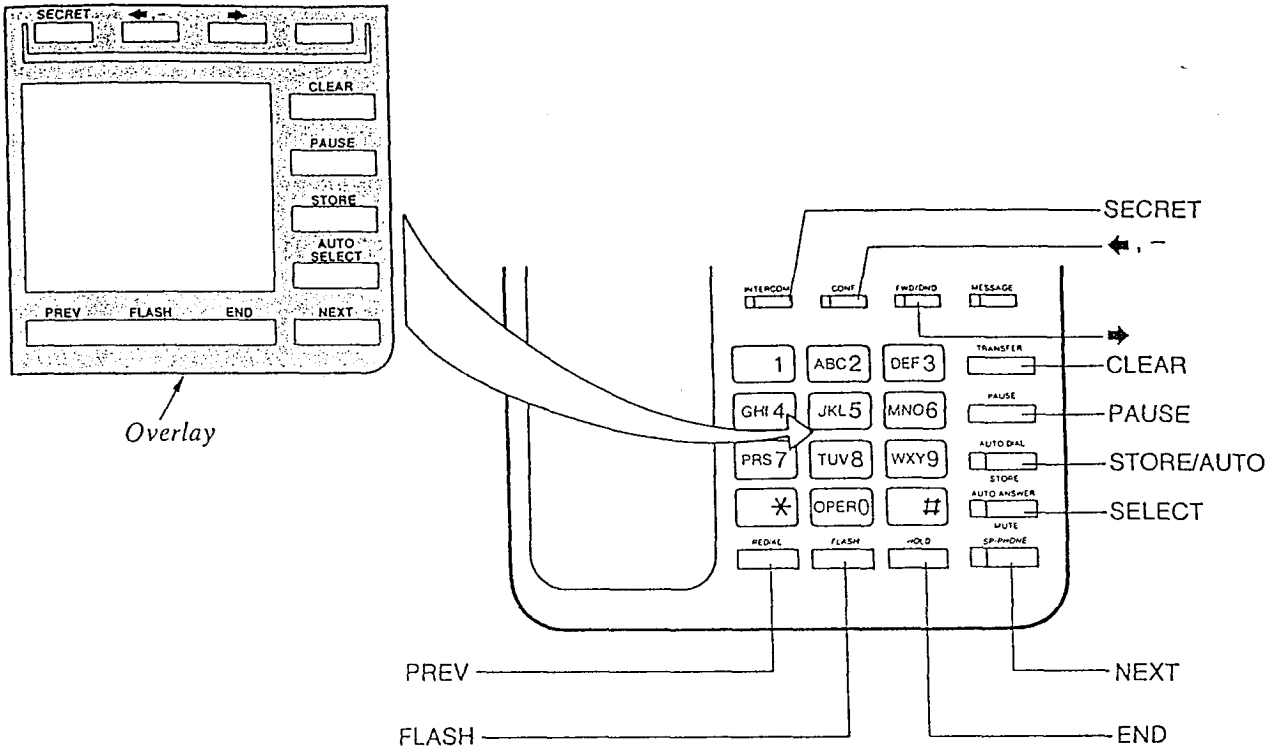

KX-T7130

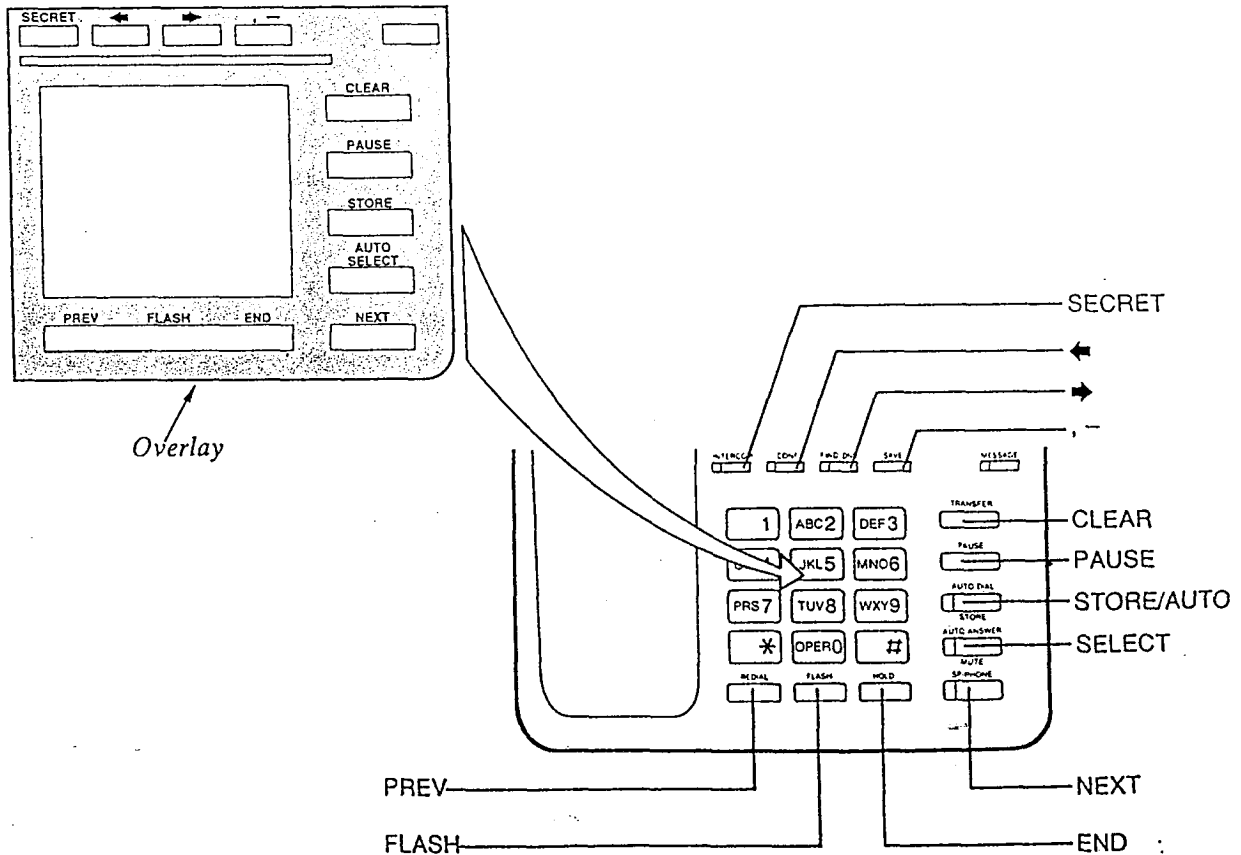

Added Features

The Parallel Connection of the Proprietary Telephone and the Standard Telephone

- Any extension can be connected in parallel with the proprietary telephone and the standard telephone.
- In the event of a power failure, CO 1 through CO 6 can be accessed using the standard telephones that are connected in parallel with proprietary telephones to extension numbers 11 through 16 respectively.
- If the extension receives a call, a ringing will be heard from the proprietary telephone and the standard telephone. You can answer the call by using either the proprietary telephone or the standard telephone.
- An answering machine, a facsimile, a MODEM (personal computer) etc. can be connected instead of the standard telephone.
- You can program that the standard telephone will not work. For programming, refer to the "Standard Telephone Connection with Proprietary Telephone" on page 8 in this manual.

Note:

- The LCD on the proprietary telephone will show you the standard telephone is used.
- The following features will not work by the standard telephone connected in parallel with the proprietary telephone.
 - Call splitting
 - External feature access
 - Conference
 - Pickup dialing
 - Account code input
- The standard telephone connected in parallel with the proprietary telephone will not make a call in the following cases;
 - The proprietary telephone is set to BGM mode.
 - The proprietary telephone is receiving the paging through the built-in-speaker.
 - The proprietary telephone is set to PROGRAMMING mode.
- The standard telephone connected in parallel with the proprietary telephone will not ring in the following cases;
 - The proprietary telephone is set to Automatic Answer-Intercōm.
 - The proprietary telephone is set to Voice alerting mode.

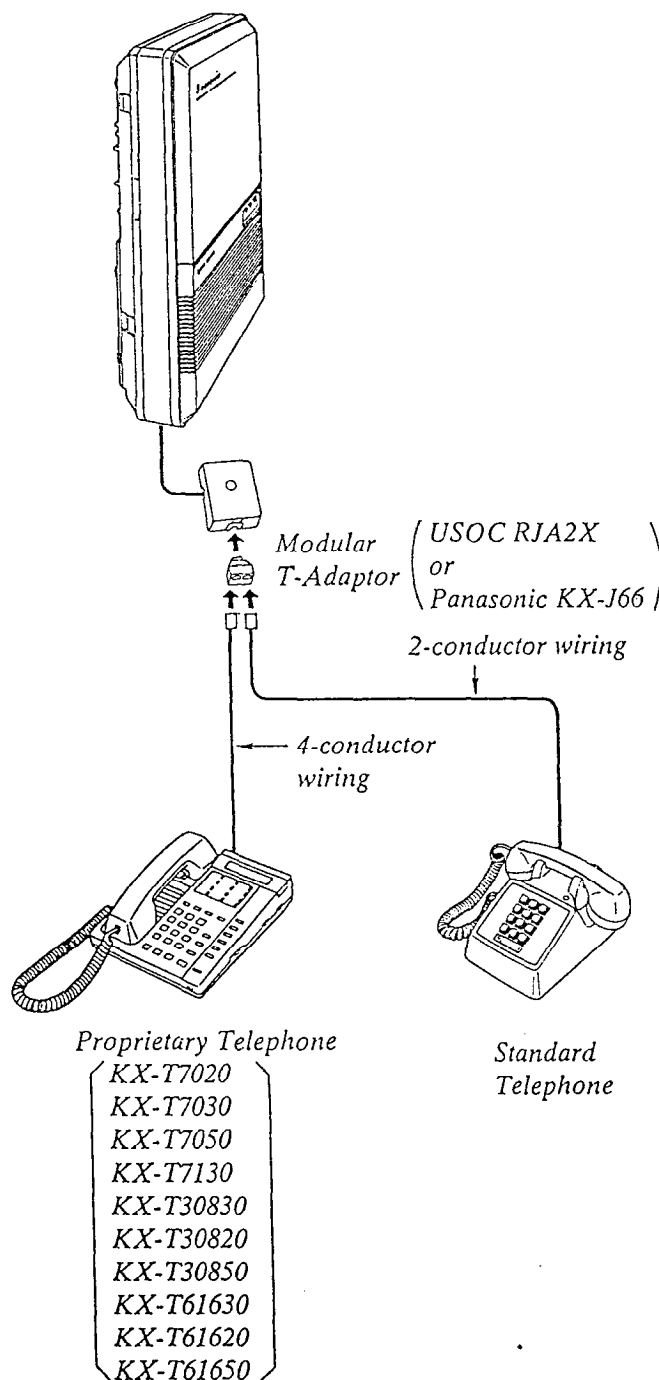

Connection of the Optional Door Opener Adaptor (KX-T30866)

For installing the Door Opener, use the Optional Door Opener Adaptor (KX-T30866).

I. Wiring connection from the Door Opener

① Loosen the screw and remove the cover.

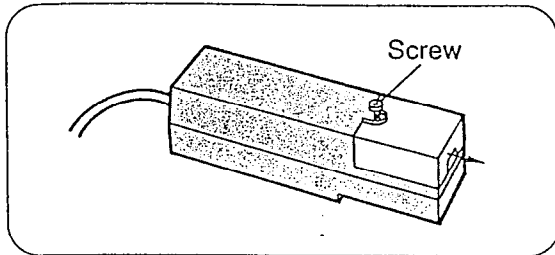

② Loosen the screws.

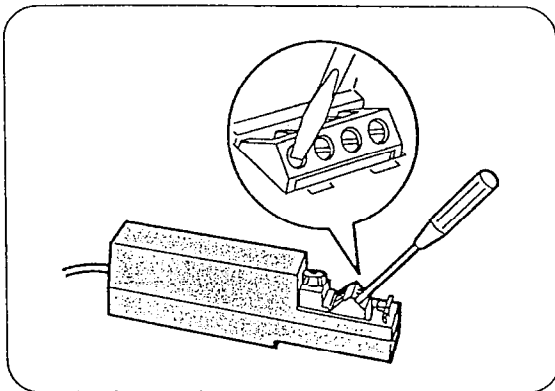

③ Insert the wires coming from the door openers in the direction of the arrows and tighten the screws, then secure the cords with the cord strap (included).

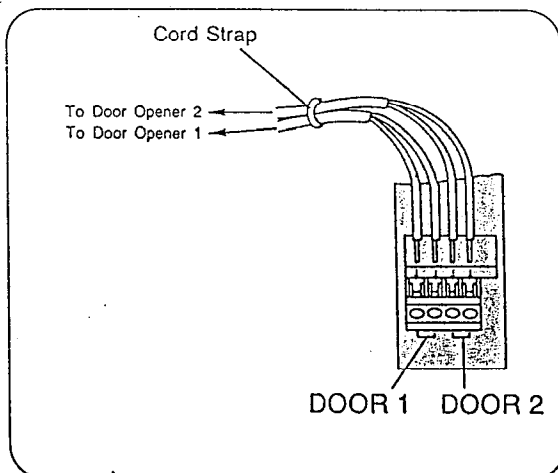

④ Put the cover in position and tighten the screw.

2. Insert the door opener adaptor.

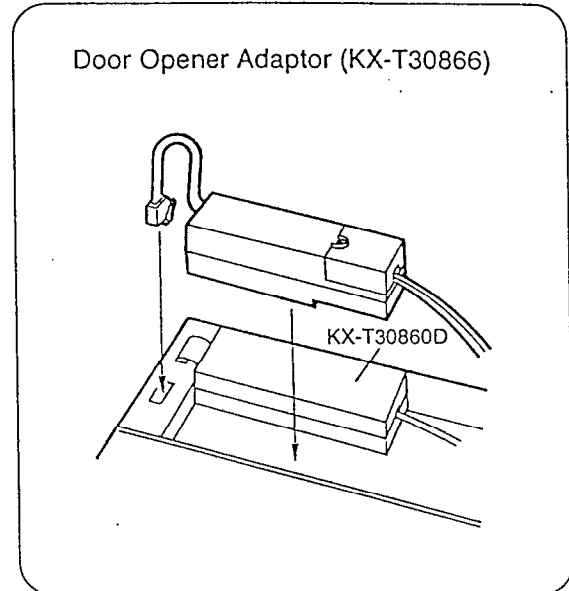

■ Block Diagram

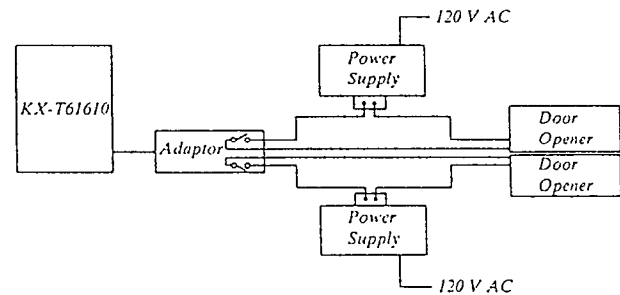

Note:

- Power Supply, Door Opener and Wiring are not included of the Door Opener Adaptor, KX-T30866.
- For wiring, it is recommended to use AWG22 twisted wire or thicker wire.
- The relay contact is able to operate with MAX 50V AC, 1A or MAX 30V DC, 1A.

Standard Telephone Connection with Proprietary Telephone

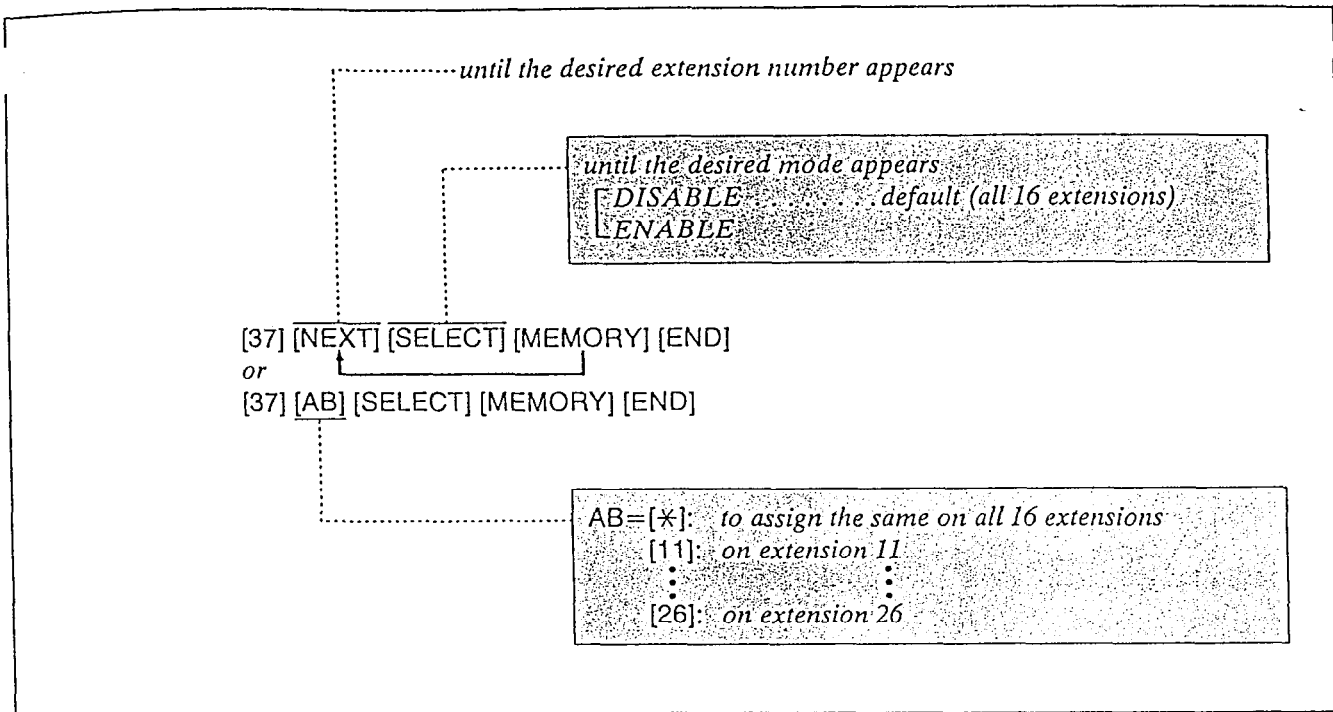

Description

You can select whether the standard telephone which is connected in parallel with the proprietary telephone works or not.

ENABLE..... The standard telephone works.
 DISABLE..... The standard telephone does not work.

Programming

1. Dial (37).
 "ENTER EXT NO" will be displayed.
2. Press the NEXT button until the desired extension number appears.
 "11:DISABLE" will be displayed and "DISABLE" will blink.
3. Press the SELECT button to alternate between ENABLE and DISABLE and select the desired mode.
4. Press the MEMORY button.
5. Repeat steps 2 to 4 to program the assignment of the other extensions.

6. To return to the initial programming mode, press the END button.

Conditions

- If you start the programming from step 1, you may dial the desired extension number instead of NEXT button at step 2.
- The PREV button allows you to return to the previous extension.
- When a call reaches to the KX-T30830 and KX-T61630, two types of ring will sound. We recommend you to select DISABLE by programming if you do not use the standard telephone that is connected in parallel.

Programming Table

See page 42.

F1/SAVE Selection

(for KX-T61650, KX-T30850, KX-T7020, KX-T7030, KX-T7050)

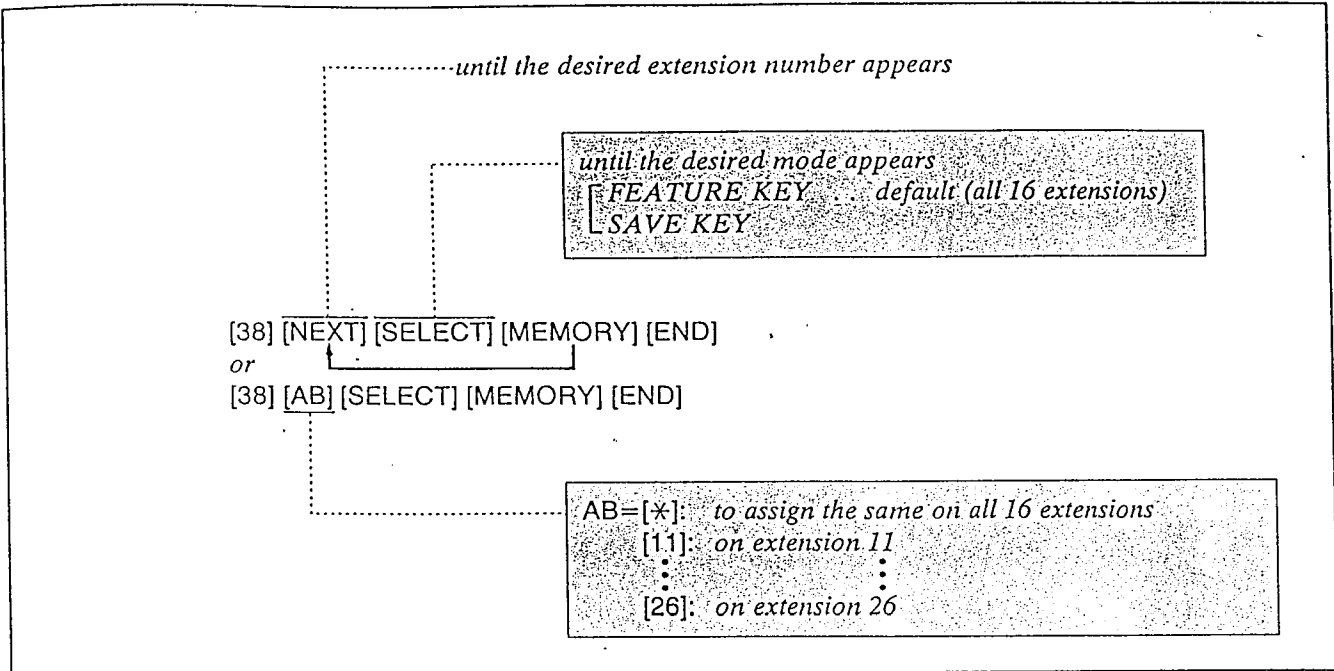

Description

The SAVE button is not provided with KX-T61650, KX-T30850, KX-T7020, KX-T7030 and KX-T7050.

F1 button can be changed from programmable feature button to SAVE button.

"FEATURE KEY" mode ...

programmable feature function

"SAVE KEY" mode ... SAVE function

4. Press the MEMORY button.

5. Repeat steps 2 to 4, to program SAVE button of the other extensions.

6. To return to the initial programming mode, press the END button.

Programming

1. Dial (38).

"ENTER EXT NO" will be displayed.

2. Press the NEXT button.

"11: FEATURE KEY" is displayed and the "FEATURE KEY" will blink.

3. Press the SELECT button to alternate between FEATURE KEY and SAVE KEY and select the desired mode.

Conditions

- You may dial the desired extension number which needs SAVE button instead of NEXT button at step 2.
- The PREV button allows you to go the previous extension for displaying the F1/SAVE selection.

Programmable Table

See page 42.

Programmable Executive Override

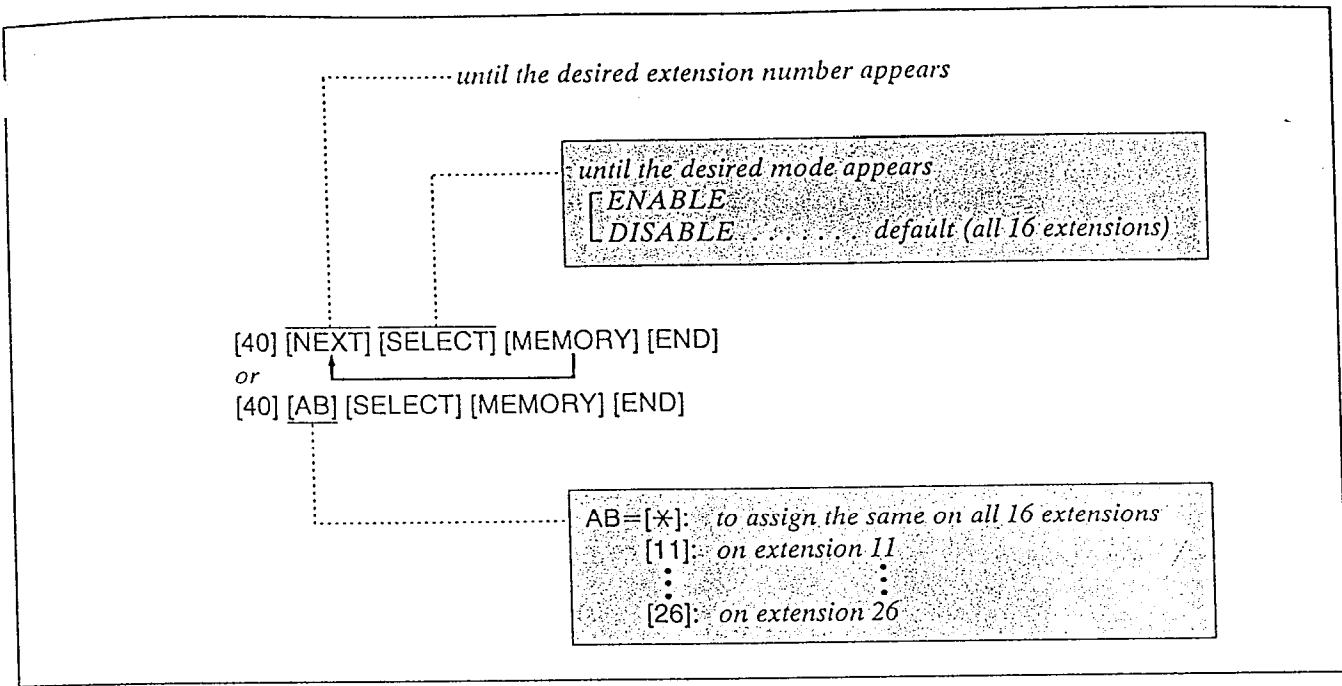

Description

Through programming, you can select which extension may barge in another extension that is in conversation with an outside party.

Programming

1. Dial (40).
"ENTER EXT NO" will be displayed.
2. Press the NEXT button.
"11:DISABLE" will be displayed and "DISABLE" will blink.
3. Press the SELECT button to alternate between ENABLE and DISABLE and select the desired mode.
4. Press the MEMORY button.
•The LCD will stop blinking.
5. Repeat steps 2 to 4 to program the assignment of the other extensions.
6. To return to the initial programming mode, press the END button.

Conditions

- If you start the programming from step 1, you may dial the desired extension number instead of NEXT button at step 2.
- The PREV button allows you to return to the previous extension for displaying the Executive Override selection.

Programming Table

See page 42.

Automatic Designated CO Line Access

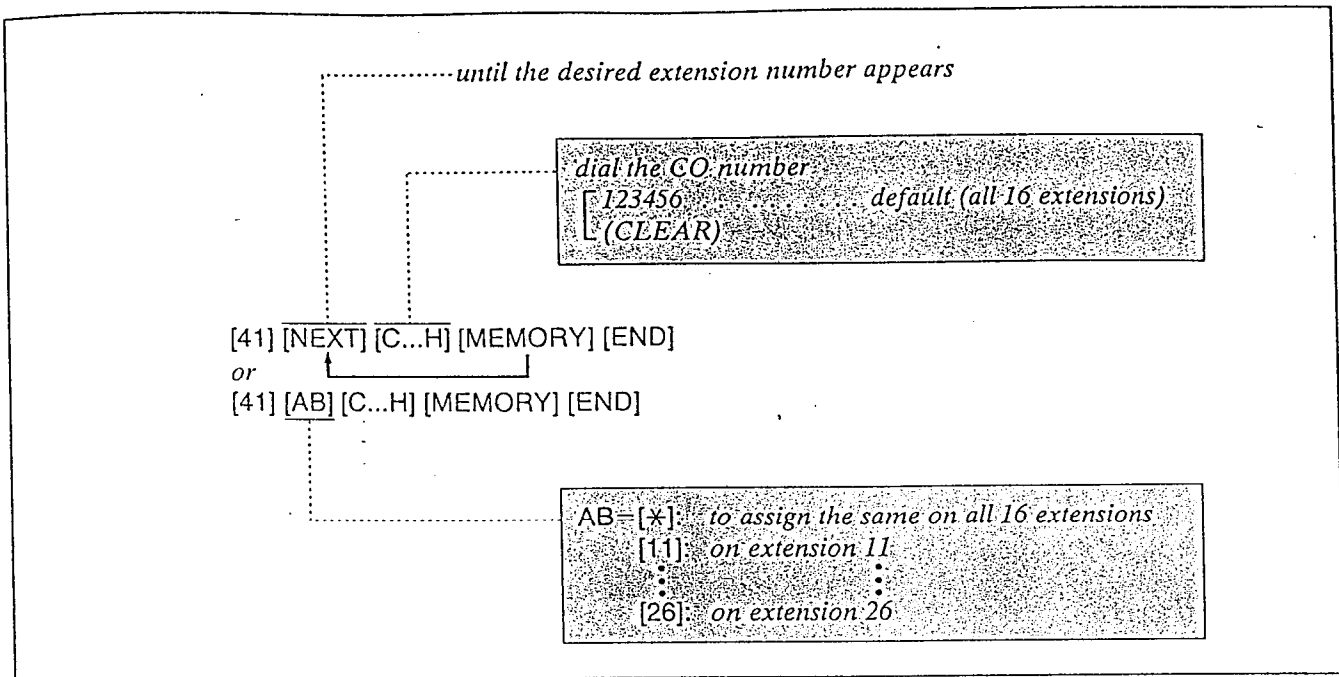

Description

Through programming, you can select which CO Line is accessed automatically when you dial 9 to use the "Automatic Line Access" feature or you use the "Auto CO Hunting" feature.

Conditions

- When you start the programming from step 1, you may dial the desired extension number instead of NEXT button at step 2.
- The PREV button allows you to go to the previous extension for displaying the CO assignment.

Programming

1. Dial (41).
"ENTER EXT NO" will be displayed.
2. Press the NEXT button.
"11:CO 123456" will be displayed and "123456" will blink.
3. Dial the CO Numbers to be entered.
To cancel the entered CO Number, press the CLEAR button.
4. Press the MEMORY button.
 - The LCD will stop blinking.
5. Repeat steps 2 to 4 to program the assignment of the other extensions.
6. To return to the initial programming mode, press the END button.

Programming Table

See the back cover.

Programmable Call Waiting Tone

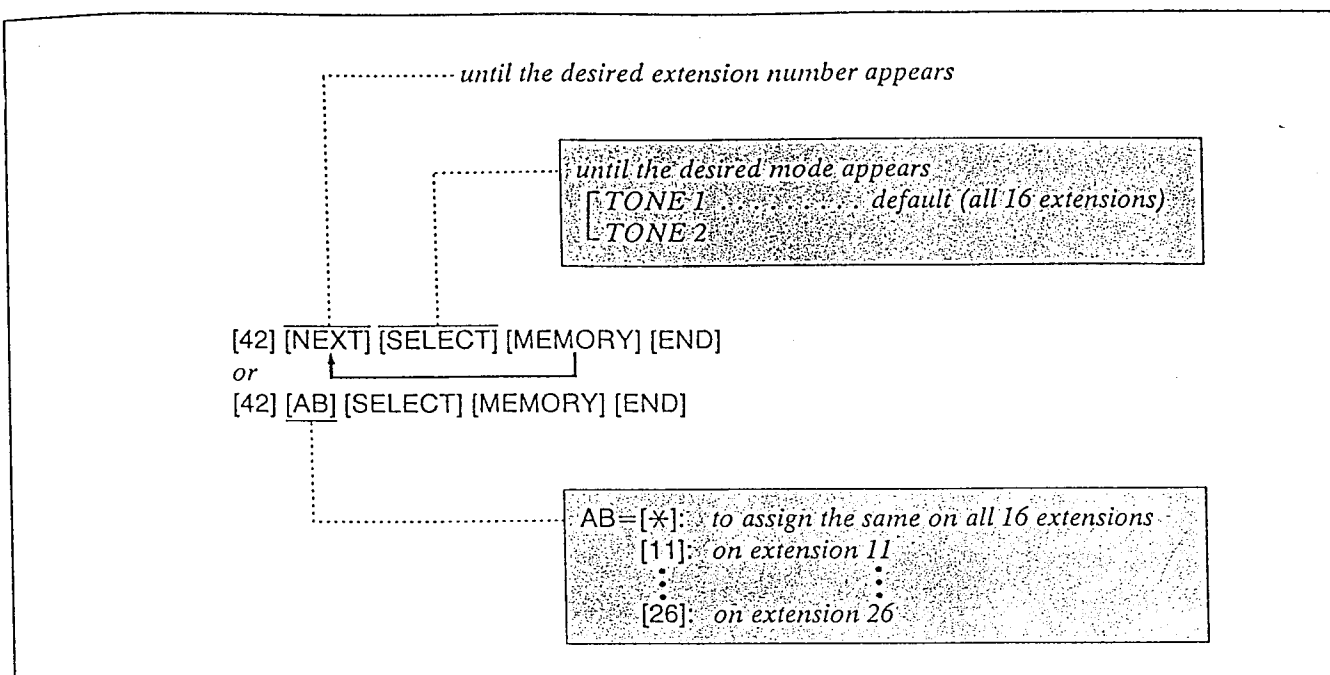

Description

Through programming, you can change the Call Waiting Tone from Tone 1 to Tone 2 shown below to prevent the user from missing the tone. Tone 1 is heard from the handset receiver of the standard telephone and the built-in speaker of the proprietary telephone.

Tone 2 is heard only from the built-in speaker of the proprietary telephone when you have another call.

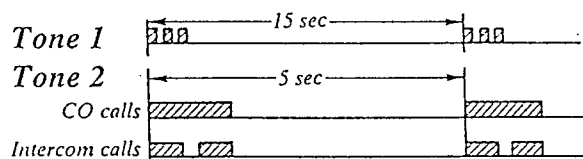

Programming

1. Dial (42).
 "ENTER EXT NO" will be displayed.
2. Press the NEXT button.
3. Press the SELECT button to alternate between "TONE 1" and "TONE 2" and select the desired tone.
4. Press the MEMORY button.
 • The LCD will stop blinking.

5. Repeat steps 2 to 4 to program the assignment of the other extensions.

6. To return to the initial programming mode, press the END button.

Conditions

- As for the KX-T61650 and KX-T30850, Tone 2 is heard from both the handset receiver and the built-in speaker while having a conversation.
- Call Waiting feature should be programmed "ON" beforehand. Refer to page 3-28 in another INSTALLATION MANUAL for the programming.
- When you start the programming from step 1, you may dial the desired extension number instead of NEXT button at step 2.
- The PREV button allow you to go to the previous extension for displaying the Call Waiting mode.
- For operation, see page 4-16 "Call Waiting" in another Installation Manual.

Programming Table

See the back cover.

Door Opener Assignment

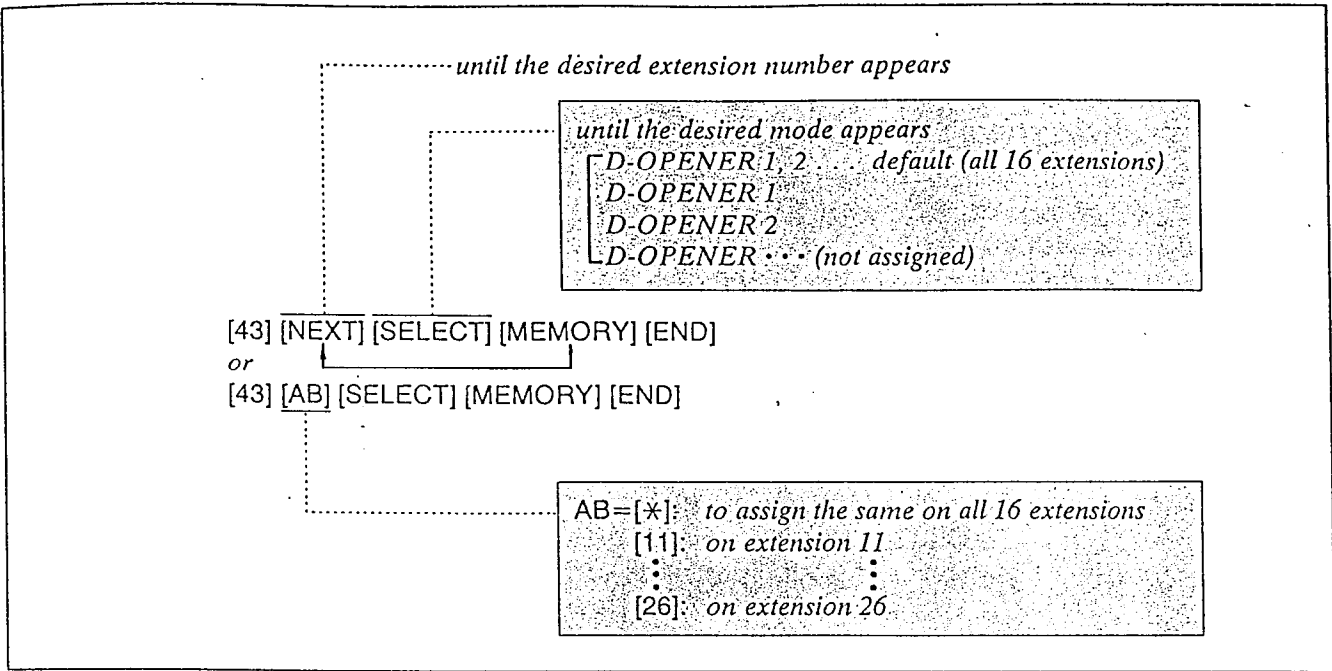

Description

Allows each extension to be programmed for unlocking the door. Up to 2 Door Openers can be connected to the system.

Programming

1. Dial (43).
"ENTER EXT NO" will be displayed.
2. Press the NEXT button.
"11:D-OPENER 1, 2" will be displayed and "1, 2" will blink.
3. Keep pressing the SELECT button until the desired combination of door openers is displayed.
4. Press the MEMORY button.
⊙The LCD will stop blinking.
5. Repeat steps 2 to 4 to program the combination of the other extensions.
6. To return to the initial programming mode, press the END button.

Conditions

- When you start the programming from step 1, you may dial the desired extension number instead of NEXT button at step 2.
- The PREV button allows you to go to the previous extension for displaying the door opener assignment.

Example:

To allow extension 12 to open the D-OPENER 2.

[43] [12] [SELECT] [SELECT] [MEMORY] [END]

- For installation and operation of the Door Opener, see pages 7 and 21.

Programming Table

See the back cover.

Carrier Codes Assignment

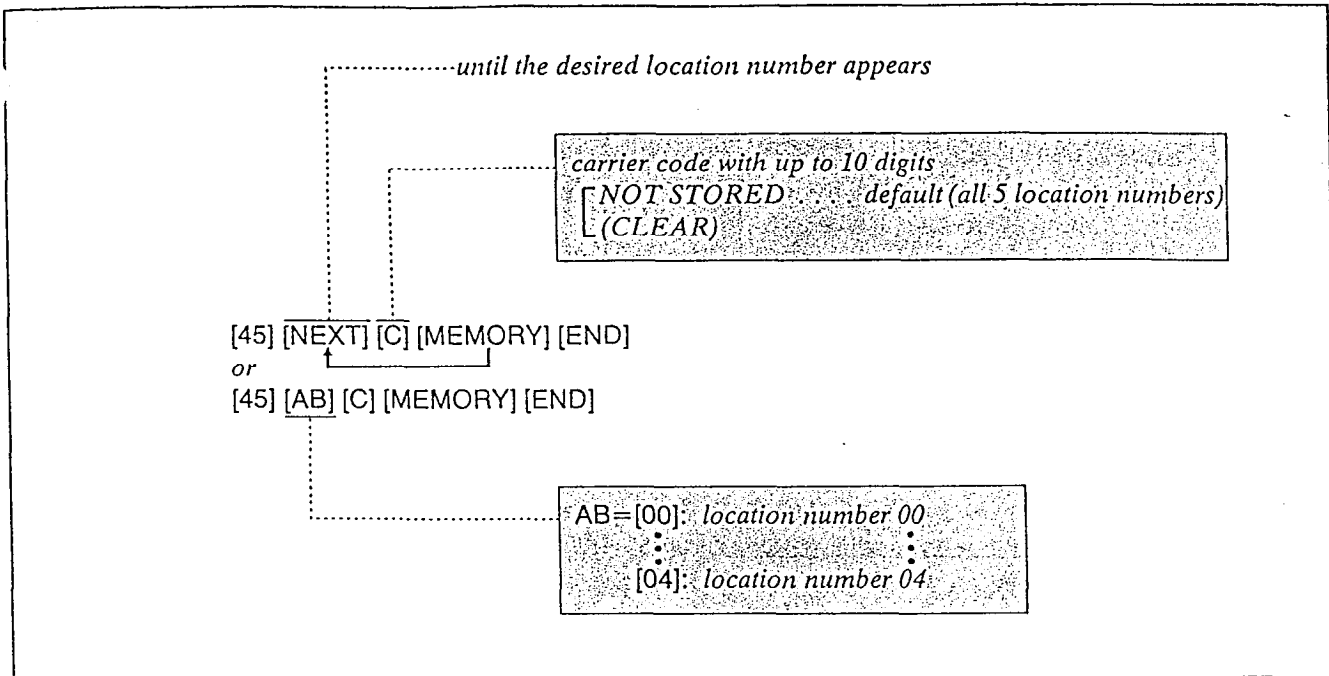

Description

Through programming, up to 5 carrier codes to access OCC (other common carrier), etc. can be assigned.

When a phone number which has an assigned carrier code is dialed, Toll Restriction check starts from the number that is dialed after the carrier code.

Programming

1. Dial (45).
"ENTER CODE NO" will be displayed.
2. Dial (00 through 04) or press the NEXT button.
Example:
When dial (00) or press the NEXT button.
 - The LCD will show "00:NOT STORED" when nothing is stored in location number "00". When the carrier code 10222 has been stored, "00:10222" will be displayed.
3. Enter the carrier code with up to 10 digits.
 - To erase a wrong entry, press the CLEAR button.
4. Press the MEMORY button.
 - The memory indicator will be lit.

5. To advance to the next location number, press the NEXT button.
To return to the previous location number, press the PREV button.
To go to a desired location number, press the SELECT button and then dial the number.
6. Repeat steps 3 to 5.
7. To return to the initial programming mode, press the END button.

Condition

- "*" substitutes for any numbers.

Programming Tables

See the back cover.

Automatic Redial

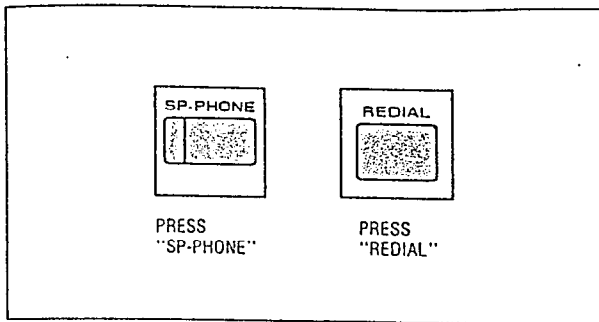

Description

The last phone number dialed on an outgoing call to CO line can be redialed up to 15 times. This feature is available for only KX-T7020, KX-T7030, KX-T7050 and KX-T7130.

Operation

1. Press the SP-PHONE button.
2. Press the REDIAL button.

You may press the CO button to select the CO line directly after pressing the SP-PHONE button.

Conditions

- To cancel automatic redialing, press the FLASH button.
- Pressing the REDIAL or SAVE button allows you to:
 - Redial once when using the handset.
 - Redial up to 15 times within 10 minutes when using the Redial feature with the SP-PHONE button.

Flexible CO Button

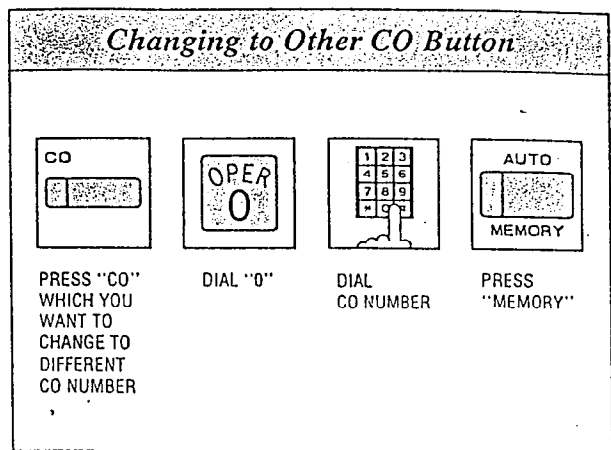

Description

Allows each CO button number to be changed to a different CO number.

Operation

- Be sure the handset is on the cradle and the SP-PHONE button is off.
 - Set the MEMORY switch of the proprietary telephone to "PROGRAM".
1. Press the CO button which you want to change to a different CO number. When pressing CO 1 button, "CO 1" will be displayed.
 2. Dial (0). "CO" will be displayed.
 3. Dial the new CO number (1 through 6). When dialing (2), "CO 2" will be displayed.
 4. Press the MEMORY button.
- After programming, return the MEMORY switch to the "SET" position.

Conditions

If you program the same CO number as another CO button, the original one will be cleared.

- Initial assignment (default) for the flexible buttons is as follows:
- | | |
|------------------|---------------------|
| CO1 button...CO1 | CO7 button...DSS11 |
| CO2 button...CO2 | CO8 button...DSS12 |
| CO3 button...CO3 | CO9 button...DSS13 |
| CO4 button...CO4 | CO10 button...DSS14 |
| CO5 button...CO5 | CO11 button...DSS15 |
| CO6 button...CO6 | CO12 button...DSS16 |

Changing to DSS Button

Setting

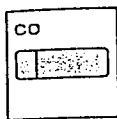

PRESS "CO" WHICH YOU WANT TO CHANGE TO DSS BUTTON

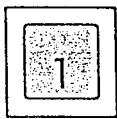

DIAL "1"

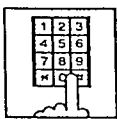

DIAL EXTENSION NUMBER

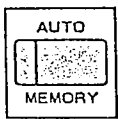

PRESS "MEMORY"

Dialing (Inter Office Calling)



LIFT HANDSET OR PRESS "SP-PHONE"

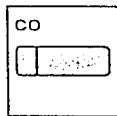

PRESS "CO" WHICH HAS BEEN CHANGED TO DSS BUTTON

Description

Allows each CO button to change to a DSS (Direct Station Selection) button. DSS button can be used instead of dialing an extension number.

Operation

Setting

- Be sure the handset is on the cradle and the SP-PHONE button is off.
 - Set the MEMORY switch of the proprietary telephone to "PROGRAM".
1. Press the CO button which you want to change to a DSS button.
When pressing the CO 1, "CO 1" will be displayed.
 2. Dial (1).
"EXT" will be displayed.
 3. Dial the extension number (11 through 26).
When dialing (11), "EXT 11" will be displayed.
 4. Press the MEMORY button.
 - After programming, return the MEMORY switch to the "SET" position.

Dialing (Inter Office Calling)

1. Lift the handset or press the SP-PHONE button.
2. Press the CO button which has been changed to DSS button.

Condition

If you program the same extension number as another CO or DSS button, the original one will be cleared.

Changing to One Touch Dialing Button

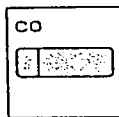

PRESS "CO" WHICH YOU WANT TO CHANGE TO ONE TOUCH DIALING

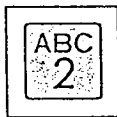

DIAL "2"

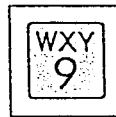

DIAL "9"

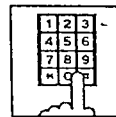

DIAL PHONE NUMBER

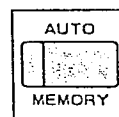

PRESS "MEMORY"

- You may dial 81 through 86 instead of 9.

Description

Allows each CO button to be used as a one touch dialing memory location. Up to 16 digits can be stored in each CO button.

Operation

- Be sure the handset is on the cradle and the SP-PHONE button is off.
 - Set the MEMORY switch of the proprietary telephone to "PROGRAM".
1. Press the CO button which you want to use as a one touch dialing memory location.
When pressing CO 1 button, "CO 1" will be displayed.
 2. Dial (2).
 3. Dial (9).
 - You may dial 81 through 86 instead of 9 to select the desired trunk.
 4. Dial the phone number.
 5. Press the MEMORY button.
 - After programming, return the MEMORY switch to the "SET" position.

Flexible MESSAGE (Message Waiting) Button (for KX-T7020, KX-T7030, KX-T7050, KX-T7130)

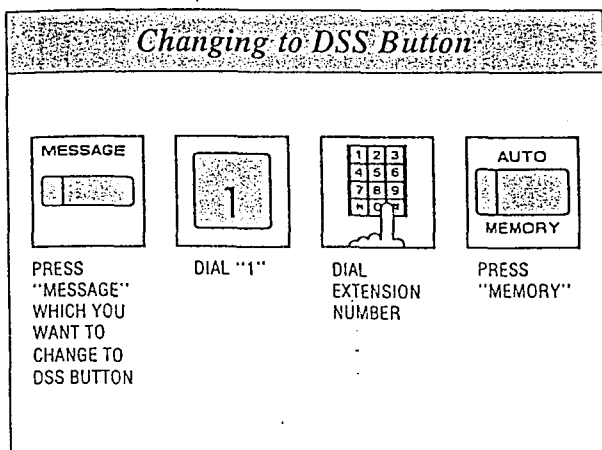

Description

Allows the MESSAGE button to change to a DSS (Direct Station Selection) button.

Operation

Setting

- Be sure the handset is on the cradle and the SP-PHONE button is off.
- Set the MEMORY switch of the proprietary telephone to "PROGRAM".

1. Press the MESSAGE button to change to a DSS button.
2. Dial (1).
3. Dial the new extension number (11 through 26).
4. Press the MEMORY button.
 - After programming, return the MEMORY switch to the "SET" position.

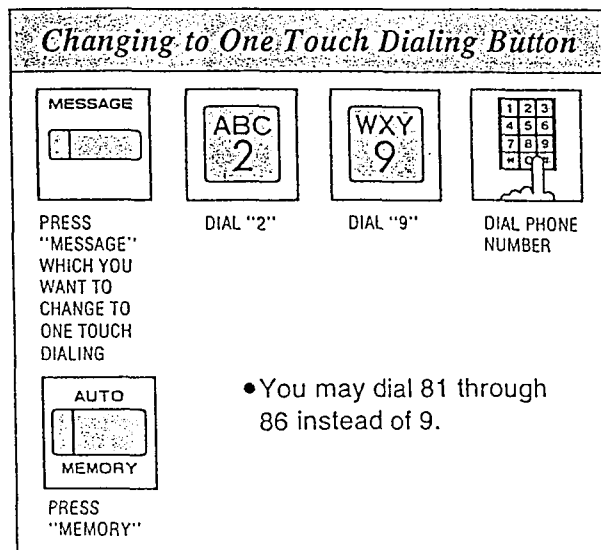

Description

Allows the MESSAGE button to be used as a one touch dialing memory location. Up to 16 digits can be stored in the MESSAGE button.

Operation

- Be sure the handset is on the cradle and the SP-PHONE button is off.
- Set the MEMORY switch of the proprietary telephone to "PROGRAM".

1. Press the MESSAGE button to change to a one touch dialing button.
2. Dial (2).
3. Dial (9).
 - You may dial 81 through 86 instead of 9 to select the desired trunk.
4. Dial the phone number.
5. Press the MEMORY button.
 - After programming, return the MEMORY switch to the "SET" position.

Flexible DSS Button (for KX-T30830)

Changing to Other DSS Button

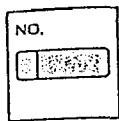

PRESS "DSS" WHICH YOU WANT TO CHANGE TO DIFFERENT EXTENSION NUMBER

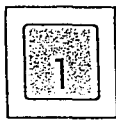

DIAL "1"

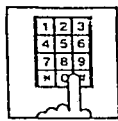

DIAL EXTENSION NUMBER

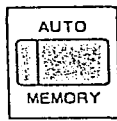

PRESS "MEMORY"

Description

Allows each DSS button to change to an extension number which is different from the default extension number.

Operation

Setting

- Be sure the handset is on the cradle and the SP-PHONE button is off.
- Set the MEMORY switch to "PROGRAM".

1. Press the DSS button which you want to change to a different extension number.
2. Dial (1).
3. Dial the new extension number (11 through 26).
4. Press the MEMORY button.
 - After programming, return the MEMORY switch to the "SET" position.

Condition

If you program the same extension number as another CO or DSS button, the original one will be cleared.

Changing to One Touch Dialing Button

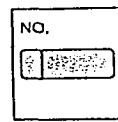

PRESS "DSS" WHICH YOU WANT TO CHANGE TO ONE TOUCH DIALING

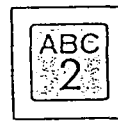

DIAL "2"

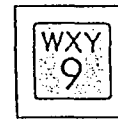

DIAL "9"

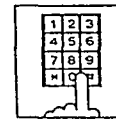

DIAL PHONE NUMBER

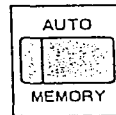

PRESS "MEMORY"

- You may dial 81 through 86 instead of 9.

Description

Allows each DSS button to be used as a one touch dialing memory location. Up to 16 digits can be stored in each DSS button.

Operation

- Be sure the handset is on the cradle and the SP-PHONE button is off.
 - Set the MEMORY switch to "PROGRAM".
1. Press the DSS button which you want to use as a one touch dialing memory location.
 2. Dial (2).
 3. Dial (9).
 - You may dial 81 through 86 instead of 9 to select the desired trunk.
 4. Dial the phone number.
 5. Press the MEMORY button.
 - After programming, return the MEMORY switch to the "SET" position.

Changing to Other DSS Button

NO. []

DIAL "1"

DIAL EXTENSION NUMBER

AUTO MEMORY

PRESS "DSS" WHICH YOU WANT TO CHANGE TO DSS BUTTON

PRESS "MEMORY"

Description

Allows each DSS button to change to an extension number which is different from the default extension number.

Operation

- Be sure the handset is on the cradle and the SP-PHONE button is off.
- Set the MEMORY switch of the paired telephone to "PROGRAM".

1. Press the DSS button to change to a DSS button of the console.
2. Dial (1).
3. Dial the desired extension number (11 through 26).
4. Press the MEMORY button.

- After programming, return the MEMORY switch to the "SET" position.
- DSS console and the paired proprietary telephone should be preprogrammed. For programming, see page 3-8 in another Installation Manual.

Changing to One Touch Dialing Button

NO. []

DIAL "2"

DIAL "9"

DIAL PHONE NUMBER

PRESS "DSS" WHICH YOU WANT TO CHANGE TO ONE TOUCH DIALING

AUTO MEMORY

PRESS "MEMORY"

• You may dial 81 through 86 instead of 9.

Description

Allows each DSS button to be used as a one touch dialing memory location.

Up to 16 digits can be stored in each DSS button.

Operation

- Be sure the handset is on the cradle and the SP-PHONE button is off.
- Set the MEMORY switch of the paired telephone to "PROGRAM".

1. Press the DSS button which you want to change to one touch dialing memory location.
2. Dial (2).
3. Dial (9).
You may dial 81 through 86 instead of 9 to select the desired trunk.
4. Dial the phone number.
5. Press the MEMORY button.

- After programming, return the MEMORY switch to the "SET" position.

Executive Override

To barge in:



LIFT HANDSET
OR PRESS
"SP-PHONE"

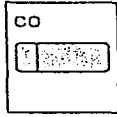

PRESS "CO"
WHOSE INDICATOR
IS RED

Description

Allows an extension user to barge in an engaged conversation for the following reasons: To establish Conference mode or to receive calls that another extension has answered.

Operation

To Establish the Conference Mode

1. Lift the handset or press the SP-PHONE button.
2. Press the CO button whose indicator is red. A 3 party conference is now established and you can barge in the conversation. "CONF" will be displayed.
3. Start talking.
4. Hang up or press the SP-PHONE button.
The other two parties will be directly connected together and can converse with each other.

Call Transfer using "Executive Override"

1. Press the CO button.
You have barged in the conversation.
- The Call Transfer will be completed when the extension user who received the call hangs up.

Conditions

- How to use the Camp-on feature when "Executive Override" is enabled at your extension. You can use the Camp-on feature without barging in the conversation.
1. Dial the busy CO line number (81 through 86) whose indicator is red instead of pressing the CO button.
 2. Dial (6).
 3. Hang up or press the SP-PHONE button.
You will be automatically called back when the CO line becomes free.
- Only one party can barge in a conversation.
 - You can not barge in the extension which is in dialing.
 - You can not barge into conversations between inside parties.
 - This feature is not available for use with standard single line telephones.
 - See page 10 for programming.

Door Opener

When the Door Opener is used with a Doorphone to unlock the Door Opener:
While talking with the visitor through the doorphone;

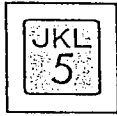

DIAL "5"



HANG UP OR
PRESS
"SP-PHONE"

The Door Opener 1 or 2 will be unlocked corresponding to the Doorphone 1 or 2.

When the Door Opener is used with an extension to unlock the Door Opener:
Hang up after confirming the call then;



LIFT HANDSET
OR PRESS
"SP-PHONE"



DIAL "551"



HANG UP OR
PRESS
"SP-PHONE"

For Door Opener 2, dial "552" instead of "551".

Description

You can easily unlock the door for about 5 seconds by dialing a proper code. Up to two Door Openers can be connected to the system. See page 13 for programming.

Operation

When the Door Opener is used with a Doorphone to unlock the Door Opener while talking with the visitor through the Doorphone:

1. Dial (5).

The confirmation tone will be heard.

The Door Opener 1 or 2 corresponding to the Doorphone 1 or 2 will be switched "ON" to unlock the door.

2. Hang up or press the SP-PHONE button.

When the Door Opener is used with an extension, to unlock the Door Opener, hang up after confirming the call then:

1. Lift the handset or press the SP-PHONE button.

2. Dial (551 (or 552)).

The Door Opener 1 (or 2) will be switched "ON" to unlock the door.

3. Hang up or press the SP-PHONE button.

Conditions

The door is unlocked for about 5 seconds.

When the power failure occurs, the Door Opener will be switched "OFF" and the door will not be unlocked.

To unlock the door for more than 5 seconds, dial (5), (551) or (552) again, and the door will be unlocked

For installation of Door Opener, see page 7.

A busy extension will not hear the call waiting tone for a doorphone call.

If you use a standard telephone to unlock the Door Opener while talking through the Doorphone, first flash the hookswitch before step 1.

Electronic Station Lock

To lock



LIFT HANDSET
OR PRESS
"SP-PHONE"



DIAL "6"

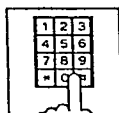

DIAL
LOCK CODE
(000 through
999)

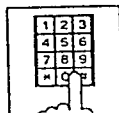

DIAL LOCK
CODE AGAIN

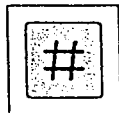

DIAL ""#""



HANG UP
OR PRESS
"SP-PHONE"

To unlock



LIFT HANDSET
OR PRESS
"SP-PHONE"

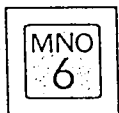

DIAL "6"

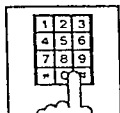

DIAL
LOCK CODE
(000 through
999)

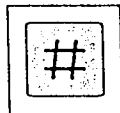

DIAL ""#""



HANG UP
OR PRESS
"SP-PHONE"

To confirm the lock code (extension 11 only)

- Be sure the handset is in the cradle and the SP-PHONE button is off.
- Set the MEMORY switch of the KX-T61630 to "PROGRAM".



DIAL ""8""

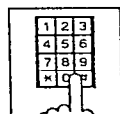

DIAL THE EXTENSION
NUMBER (11 through 26)
LOCK CODE WILL BE
DISPLAYED

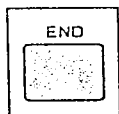

PRESS
"END"

- You may use the NEXT or PREVIOUS button instead of dialing the Extension Number.

After confirming all the codes, return
the MEMORY switch to "SET".

Description

Locking an extension prohibits another user from dialing on an outside line until unlocked. Even the emergency call can not be dialed. The followings are possible at the locked extension.

- Receiving an outside call
- Dialing and receiving an intercom call
- Call pick up
- Dialing and receiving a doorphone call
- Dialing a door opener, etc.

Operation

To lock

1. Lift the handset or press the SP-PHONE button.
2. Dial (6).
3. Dial the lock code.
Lock code must be 3 digits (000 through 999).
4. Dial the same lock code again.
5. Dial (#).
"ID CODE SET" will be displayed.
6. Hang up or press the SP-PHONE button.

To unlock

1. Lift the handset or press the SP-PHONE button.
2. Dial (6).
3. Dial the lock code.
4. Dial (#).
"ID CODE RESET" will be displayed.
5. Hang up or press the SP-PHONE button.

Conditions

- When dialing to an outside line using a locked extension, reorder tone will be heard.
- Lock code must be 3 numerical-digits except the "#" and "*" buttons.
- If you use a standard telephone;
To lock, dial (0) instead of (#) at step 5.
To unlock, dial (0) instead of (#) at step 4.

Note:

To operate features after setting "Auto CO Hunting", press the ICM button instead of lifting the handset at step 1. This is because lifting the handset causes the line to be connected to a CO line.

Changed Features

The listed features and the features on the following pages 26 through 34 are revised. Please confirm and change them.

<i>Pages of the Installation Manual</i>	<i>Titles of features</i>	<i>Contents</i>	<i>Original</i>	<i>Revision</i>
3-8	<i>DSS Console Assignment</i>	<i>Program address</i>	02	03
3-25	<i>Automatic Answering (Automatic/Manual) Selection</i>	<i>Program address</i>	16	27
3-26	<i>Host PBX Access Codes Assignment</i>	<i>Program address</i>	17	14
3-27	<i>Preferred CO Line Assignment</i>	<i>Program address</i>	18	15
3-28	<i>Programmable Call Waiting</i>	<i>Program address</i>	19	16
3-29	<i>Delayed Ringing Assignment</i>	<i>Program address</i>	20	17
3-30	<i>Delayed Ringing Count Selection</i>	<i>Program address</i>	21	18
3-31	<i>Intercom Alerting Mode</i>	<i>Program address</i>	22	19
3-32	<i>Programmable Doorphone</i>	<i>Program address</i>	23	20
3-33	<i>Dial Call Pickup Group Assignment</i>	<i>Program address</i>	24	21
3-34	<i>Account Code Input Mode</i>	<i>Program address</i>	25	22
3-35	<i>Duration Time Count Start Mode</i>	<i>Program address</i>	26	23
3-36	<i>Station Message Detail Recording (SMDR) Communication Parameters</i>	<i>Program address</i>	27	24
3-47	<i>Programmable External Paging Access Tone</i>	<i>Program address</i>	32	29
3-48	<i>Programmable Secret Speed Dial</i>	<i>Program address</i>	33	30
3-49	<i>Hookswitch Flash Timing</i>	<i>Program address</i>	34	31
3-50	<i>Disconnect Time</i>	<i>Program address</i>	35	32
3-51	<i>Calling Party Control (CPC) Signal</i>	<i>Program address</i>	36	33
3-52	<i>DSS Button Mode</i>	<i>Program address</i>	37	34
3-53	<i>Transfer Recall Time</i>	<i>Program address</i>	39	36
3-54	<i>M3/FWD Selection (for KX-T30850, KX-T61650)</i>	<i>Title</i>	M3	F3
		<i>Program address</i>	40	39
		<i>Available proprietary telephones</i>	<i>KX-T61650, KX-T30850</i>	<i>KX-T7050, KX-T61650, KX-T30850</i>

(cont.)

<i>Pages of the Installation Manual</i>	<i>Titles of features</i>	<i>Contents</i>	<i>Original</i>	<i>Revision</i>
4-13	<i>Call on Hold</i>	<i>Recall time</i>	<i>30s, 1min, 1min & 30s, 2min, Disable</i>	<i>30s, 1min, 2min, 3min, 4min, 5min, Disable</i>
4-14	<i>Call on Exclusive Hold</i>	<i>Recall time</i>	<i>30s, 1min, 1min & 30s, 2min, Disable</i>	<i>30s, 1min, 2min, 3min, 4min, 5min, Disable</i>
6-4	<i>DTMF Receiver Check</i>	<i>Program address</i>	38	35

The disallowed combinations of SMDR Communication Parameters. (Page 3-40)

<i>parity</i>	<i>word length</i>	<i>stop bit length</i>
<i>mark</i>	8	2
<i>space</i>	8	1
<i>space</i>	8	2
<i>none</i>	7	1
<i>even</i>	8	2
<i>odd</i>	8	2

System Speed Dialing—Class Assignment

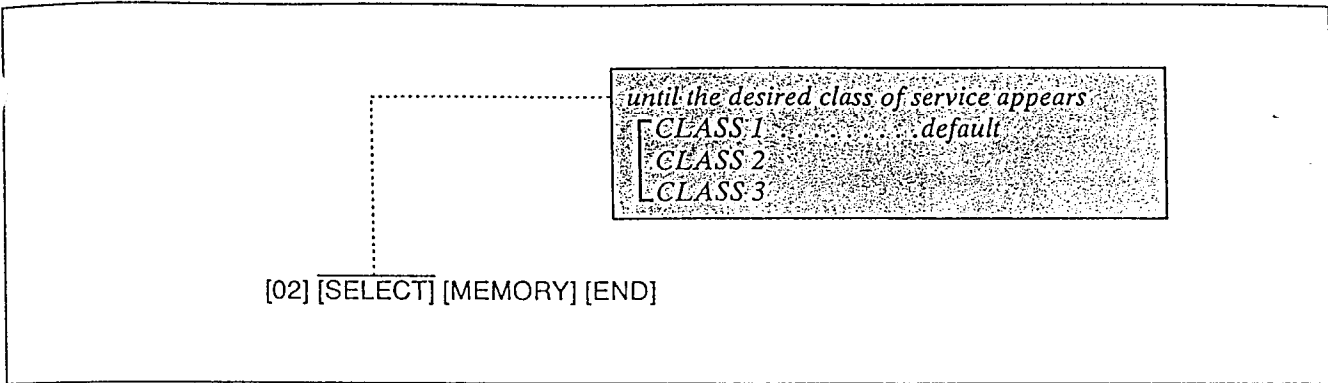

Description

You can select the class service which is free from the speed dialing toll restriction.

Programming

1. Dial (02).
"CLASS 1" will be displayed and blink.
2. Keep pressing the SELECT button until the desired class is displayed.
3. Press the MEMORY button.
4. To return to the initial programming mode, press the END button.

Conditions

If you set boundaries to CLASS 2, the system will allow system speed dialing on service class 1 and class 2, but restrict on service class 3 according to the toll restriction checking.
Refer to page 27.

		System Speed Dialing Boundary Class Assignment		
		class 1	class 2	class 3
Service class	1	A	A	A
	2	T	A	A
	3	T	T	A

A: Allowed
T: Toll Restriction check

Programming Table
See page 36.

Toll Restriction—Class Assignment

The selective use of this feature permits restricted dialing to specific stations. A class of service can be assigned to a particular station which prohibits or limits that station's dialing ability.

The followings are the available 3 classes of service.

1. Service class 1 will allow all calls.
2. Service class 2 will deny 10 codes programmed as a denied code (location 00~09) except 20 codes programmed as an exceptional code (location 00~19).
3. Service class 3 will deny 20 codes programmed as a denied code (location 00~19) except 10 codes programmed as an exceptional code (location 00~09).

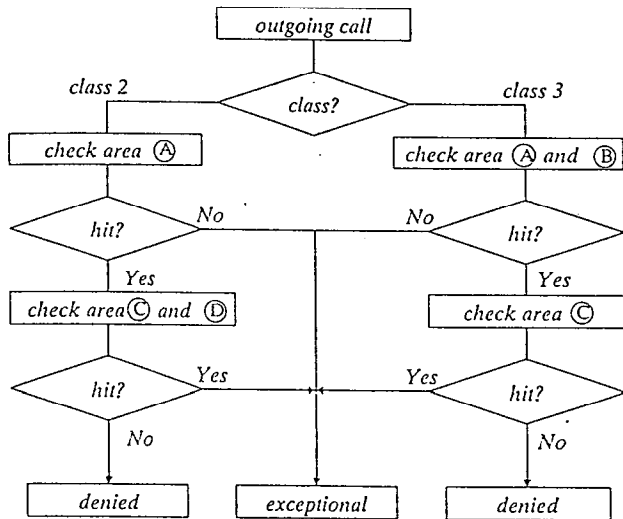

Denied Code Assignment

Code	Dial Number
00	
01	
02	
03	
04	
05	
06	
07	
08	
09	
10	
11	
12	
13	
14	
15	
16	
17	
18	
19	

Exceptional Code Assignment

Code	Dial Number
00	
01	
02	
03	
04	
05	
06	
07	
08	
09	
10	
11	
12	
13	
14	
15	
16	
17	
18	
19	

The following should be set.

- "Toll Restriction—Class Assignment" on page 28.
- "Toll Restriction—Denied Code Assignment" on page 29.
- "Toll Restriction—Exceptional Code Assignment" on page 30.
- "System Speed Dialing—Class Assignment" on page 26.

Example:

<Application>

Service Class	Denied Dial Number	Exceptional Dial Number
2	011**** 1*****	1800*** 1201***
3	011**** 0***** 1*****	1800***

<Programming>

Denied Code Assignment

CODE	ENTRY DIAL NO.
00	011****
01	1*****
02	
03	
04	
05	
06	
07	
08	
09	
10	0*****
11	
12	
13	
14	
15	
16	
17	
18	
19	

Exceptional Code Assignment

CODE	ENTRY DIAL NO.
00	1800***
01	
02	
03	
04	
05	
06	
07	
08	
09	
10	1201***
11	
12	
13	
14	
15	
16	
17	
18	
19	

Toll Restriction—Class Assignment (cont.)

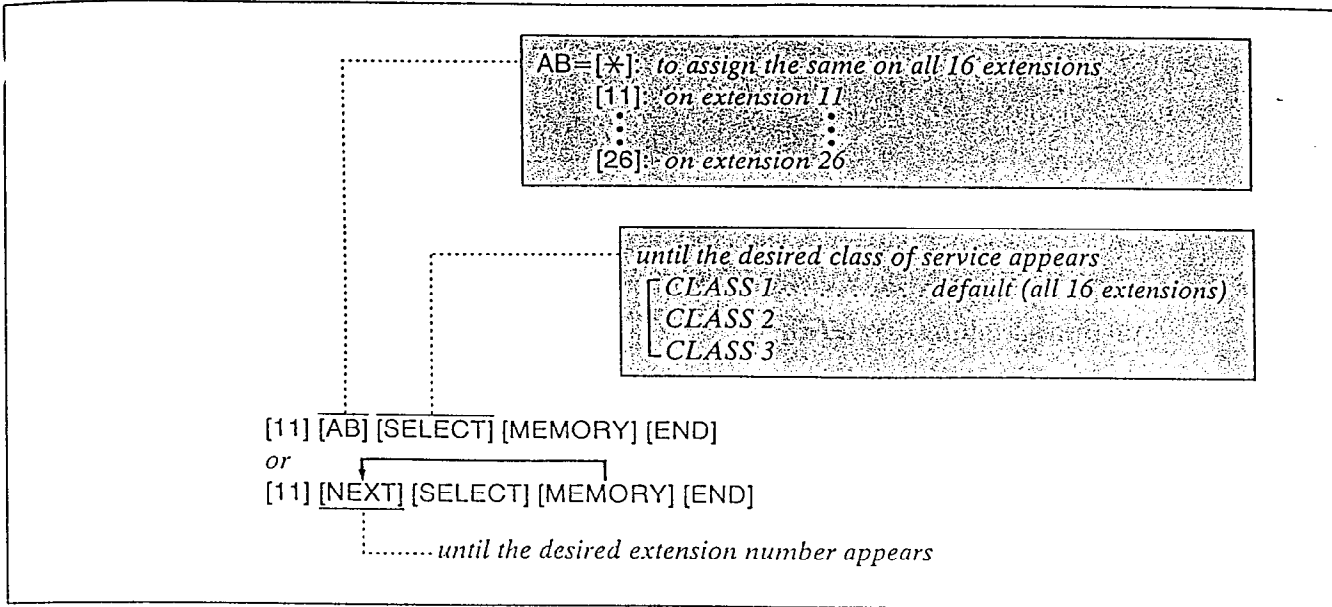

Description

Toll restriction can help eliminate phone calls abuse and control cost.

There are three classes of service available for each extension.

Programming

1. Dial (11).
"ENTER EXT NO." will be displayed.
2. Press the NEXT button.
"11: CLASS 1" will be displayed and "1" will blink.
3. Keep pressing the SELECT button until the desired class is displayed.
4. Press the MEMORY button.
5. Repeat steps 2 to 4, to program the assignment of the other extensions.
6. To return to the initial programming mode, press the END button.

Conditions

- When you start the programming from step 1, you may dial the desired extension number instead of NEXT button at step 2.
- The PREV button allows you to go to the previous extension for displaying the service class assignment.

Programming Table

See page 37.

Toll Restriction—Denied Code Assignment

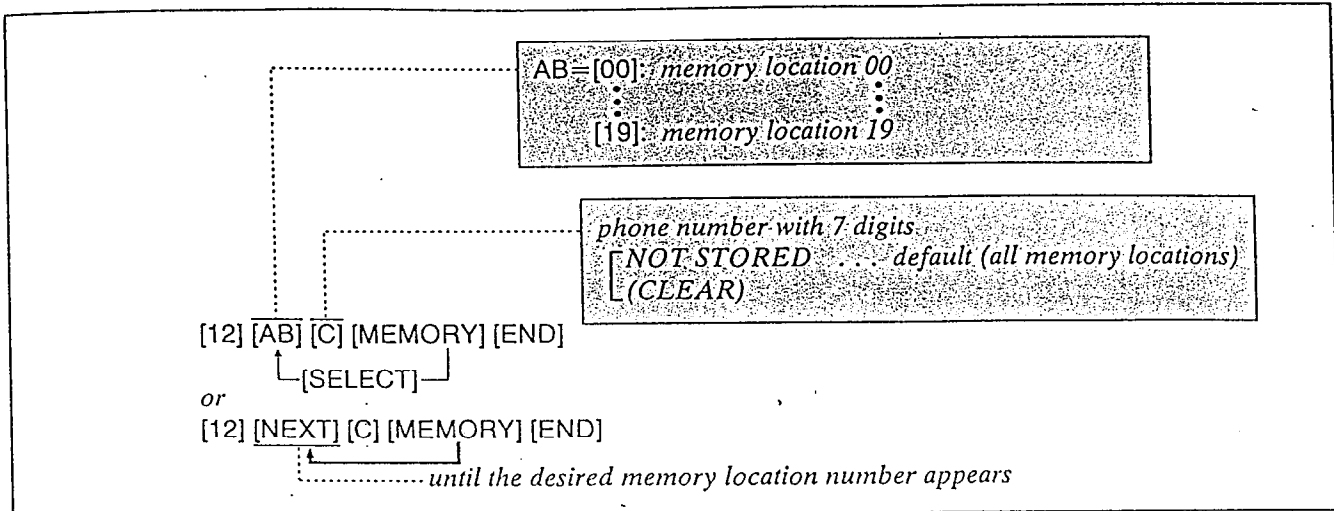

Description

For Service Class 2 or 3 (see "Toll Restriction") up to 10 or 20 phone numbers can be selected for use in toll dialing.

Phone numbers programmed will be denied. All extensions programmed for Service Class Selections shall be assigned to the same denied code assignment plan.

Memory locations 00~09 are restricted by classes 2 and 3.

Memory locations 10~19 are restricted by only class 3.

5. To advance to the next memory location number, press the NEXT button.
To return to the previous memory location number, press the PREV button.
To go to a desired memory location number, press the SELECT button and dial the memory location number.
6. Repeat steps 3 to 5.
7. To return to the initial programming mode, press the END button.

Programming

1. Dial (12).
"ENTER CODE NO." will be displayed.
2. Dial the memory location number (00 through 19) or press the NEXT button.
Example:
When dial (00) or press the NEXT button;
—When nothing is stored in memory location number "00", "00:NOT STORED" is displayed.
—When the dial number 1***** has been stored, "00:1*****" will be displayed.
3. Dial the 7-digit phone number.
 - To erase a wrong entry, press the CLEAR button.
4. Press the MEMORY button.
 - The MEMORY indicator will be lit.

Conditions

- Each phone number should consist of 7 digits.
- "*" substitutes for any numbers, see the following example.

Example:

To deny extension 14 to have access to the phone number 09 and 8 in the service class 2.

Step 1... [11] [14] [SELECT] [MEMORY] [END]

Step 2... [12] [NEXT] [09*****]
[MEMORY] [NEXT] [8*****]
[MEMORY] [END]

09*****...disables the phone numbers which start with 09.

8*****...disables the phone numbers which have 8 on the first digit.

Programming Table

See page 37.

Toll Restriction—Exceptional Code Assignment

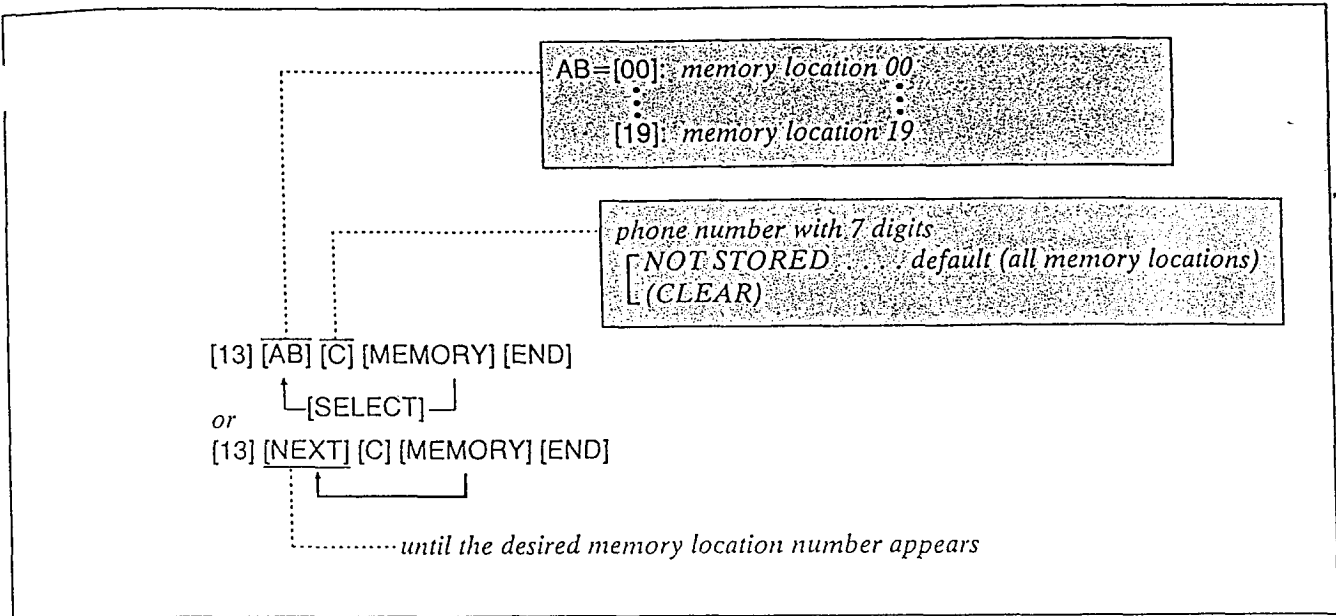

Description

Through programming, the desired extensions will be allowed to dial the phone numbers which are restricted by "Denied Code Assignment". For service Class 2 or 3, up to 10 or 20 phone numbers can be selected.

Memory locations 00-09 are not restricted by classes 2 and 3.

Memory locations 10-19 are not restricted by only class 2.

6. Repeat steps 3 to 5.

7. To return to the initial programming mode, press the END button.

Conditions

- Each phone number should consist of 7 digits.
- "*" substitutes for a number.

Programming

1. Dial (13).
"ENTER CODE NO." will be displayed.
2. Dial the memory location number (00 through 19) or press the NEXT button.
3. Dial the 7-digit phone number.
 - To erase a wrong entry, press the CLEAR button.
4. Press the MEMORY button.
 - The MEMORY button indicator will be lit.
5. To advance to the next memory location number, press the NEXT button.
To go to a desired memory location number, press the SELECT button and dial the memory location number.

Programming Table

See page 38.

System Data Dump

To start the printout

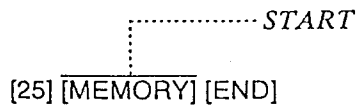

To stop the printout

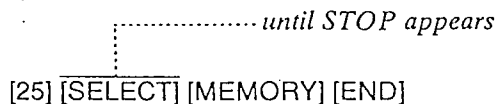

Description

The following printout is available.

- System parameters
- CO parameters
- Extension parameters
- DSS Console
- System Speed Dialing

To stop the printout;

1. Dial (25).
"START" will be displayed and blink.
2. Keep pressing the SELECT button until "STOP" is displayed.
3. Press the MEMORY button.
4. To return to the initial programming mode, press the END button.

Operation

To start the printout;

1. Dial (25).
"START" will be displayed and blink.
2. Press the MEMORY button.
3. To return to the initial programming mode, press the END button.

Programming Table

See page 40.

Description

Five contents are printable. They are (1) System parameters (2) CO parameters (3) Extension parameters. (4) DSS Console and (5) System Speed Dialing.

For further details, refer to the following Program address numbers and titles of the features.

(1) System Parameters

- [00] Date and Time Setting
- [02] System Speed Dialing—Class Assignment
- [03] DSS Console Assignments
- [05] Switching Mode (Day/Night)
- [06] Starting Time (Day/Night)
- [12] Toll Restriction—Denied Code Assignment
- [13] Toll Restriction—Exceptional Code Assignment
- [18] Delayed Ringing Count Selection
- [20] Doorphone
- [21] Call Pickup Group Assignment
- [23] Duration Time Count Start Mode
- [24] SMDR (Station Message Detail Recording) parameters
- [26] SMDR Incoming/Outgoing Selection
- [28] Hold Recall Time Set
- [29] External Paging Access Tone
- [30] Secret Speed Dial
- [34] DSS Button Assignment
- [36] Transfer Recall Time
- [45] Carrier Codes Assignment

(2) CO Parameters

- [04] Dial Mode (Tone/Pulse) Selection
- [14] Host PBX Access Code
- [31] Hookswitch Flash Time
- [32] Disconnect Time
- [33] Calling Party Control (CPC) Signal

(3) Extension Parameters

Type: Proprietary telephone or Standard telephone

- [07] Flexible Day Outward Dialing Assignment
- [08] Flexible Night Outward Dialing Assignment
- [09] Flexible Day Ringing Assignment
- [10] Flexible Night Ringing Assignment
- [11] Toll Restriction—Class Assignment
- [15] Preferred CO Line Assignment
- [16] Call Waiting
- [17] Delayed Ringing Assignment
- [19] Intercom Alerting Mode
- [22] Account Code Input Mode
- [27] Automatic Answering Selection
- [37] Standard Telephone Connection with Proprietary Telephone

- [40] Executive Override
- [41] Automatic Designated CO Line Access
- [42] Call Waiting Tone
- [43] Door Opener Assignment
- [PF] Feature Button Assignment
- [CO] CO Button Assignment
- [MW] Message Waiting Button Assignment

(4) DSS Console

- [PF] Feature Button Assignment
- [DS] DSS Button Assignment

(5) System Speed Dialing

- [01] System Speed Dialing Entry

Note:

• For the programming address [38] F1/SAVE Selection and [39] F3/FWD Selection, see the [PF] 01 and [PF] 03 of Extension Parameters. If KX-T30830 is connected to an extension, (3) Extension parameters, [CO] CO Button Assignment 01 through 12 show the following button assignment:

[CO]01 CO1	[CO]08 DSS4
[CO]02 CO2	[CO]09 DSS5
[CO]03 CO3	[CO]10 DSS6
[CO]05 DSS1	[CO]11 DSS7
[CO]06 DSS2	[CO]12 DSS8
[CO]07 DSS3	

Station Message Detail Recording (SMDR) Incoming/Outgoing Selection

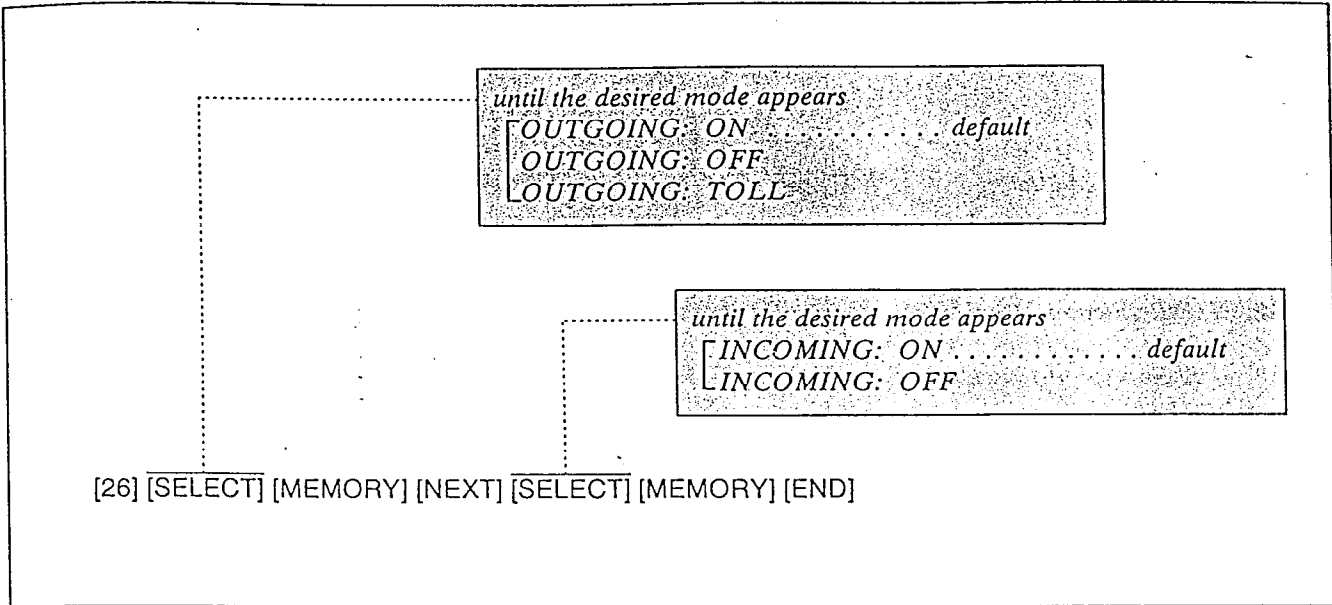

Description

It is possible to print either outgoing outside calls, or outgoing outside toll calls, and/or incoming outside calls.

OUTGOING: ON...to print all outgoing outside calls.

OUTGOING: OFF...to stop printing

OUTGOING: TOLL...to print only outgoing outside toll calls

INCOMING: ON...to print incoming outside calls

INCOMING: OFF...to stop printing

- When "OUTGOING: TOLL" is selected, outgoing outside calls to the phone numbers which are programmed in "Toll Restriction Denied Code Assignment" on page 29 are printed out.

Programming

1. Dial (26).

"OUTGOING: ON" will be displayed and the "ON" will blink.

2. Press the SELECT button to alternate between the "ON", "OFF" and "TOLL" and select the desired mode.

3. Press the MEMORY button.
The LCD will stop blinking.

4. Press the NEXT button.
"INCOMING: ON" will be displayed and the "ON" will blink.

5. Press the SELECT button to alternate between "ON" and "OFF" and select the desired mode.

6. Press the MEMORY button.
The LCD will stop blinking.

7. To return to the initial programming mode, press the END button.

Programming Table

See page 41.

Hold Recall Time Set

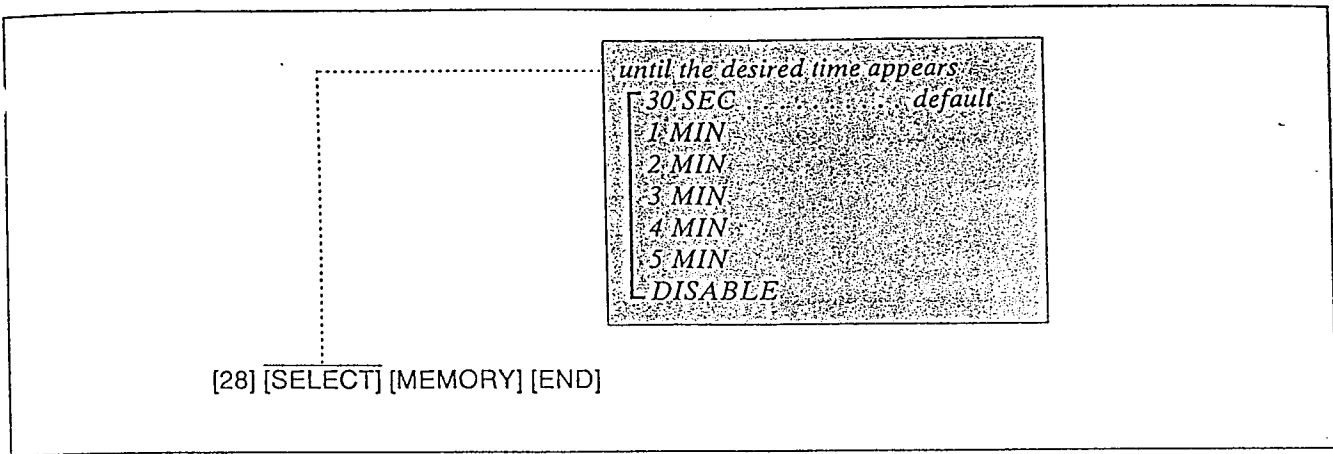

Description

This will inform you that you keep holding the line by ringing, after the time passes.

Programming

1. Dial (28).
"TIME: 30 SEC" will be displayed and "30 SEC" will blink.
2. Keep pressing the SELECT button until the desired time is displayed.
3. Press the MEMORY button.
4. To return to the initial programming mode, press the END button.

Example:

2 minutes=[28] [SELECT] [SELECT]
[MEMORY] [END]

Programming Table

See page 41.

Canceled Features

The listed features are canceled from KX-T61610.

<i>Pages of Installation Manual</i>	<i>Program Address</i>	<i>Title</i>
3-1	98	Station Program Clear
3-10	03	CO Connection Assignment
3-22	13	Programmable Toll Prefix
3-23	14	Programmable Operator Call
3-24	15	Programmable Directory Assistance
3-45	30	Hold Time Reminder

PROGRAMMING TABLE

TO SET	PROGRAM ADDRESS	STEPS REQUIRED TO CHANGE PROGRAM																																																																																																																																																
Date and Time Setting	[00]	<p>[A] [↔] [SELECT] [↔] [B] [↔] [SELECT] [↔] [C] [↔] [D] [↔] [SELECT] [MEMORY] [END]</p> <p>.....yearmonthdayhourminuteAM/PM</p> <p>.....day of the week</p>																																																																																																																																																
System Speed Calling Entry	[01] or [AUTO]	<p>[AB] [CD] [phone number] [MEMORY]</p> <p>.....[9]: automatic line access number</p> <p>.....[81] through [86]: outside line access number</p> <p>..... speed access code (00 through 99)</p>																																																																																																																																																
System Speed Dialing—Class Assignment	[02]	<p>[SELECT] [MEMORY] [END]</p> <p>.....until the desired boundary class appears</p> <table border="1" style="width: 100%; border-collapse: collapse;"> <thead> <tr> <th style="width: 33%;"></th> <th style="width: 33%; text-align: center;">Default</th> <th style="width: 33%; text-align: center;">To make a change</th> </tr> </thead> <tbody> <tr> <td>CLASS 1</td> <td style="text-align: center;">x</td> <td></td> </tr> <tr> <td>CLASS 2</td> <td></td> <td></td> </tr> <tr> <td>CLASS 3</td> <td></td> <td></td> </tr> </tbody> </table>		Default	To make a change	CLASS 1	x		CLASS 2			CLASS 3																																																																																																																																						
	Default	To make a change																																																																																																																																																
CLASS 1	x																																																																																																																																																	
CLASS 2																																																																																																																																																		
CLASS 3																																																																																																																																																		
DSS Console Assignment	[03]	<p>[AB] [↔] [CD] [↔] [EF] [↔] [GH] [MEMORY] [END]</p> <p>..... Telephone extension number paired with console 2</p> <p>..... Console 2 extension number</p> <p>..... Telephone extension number paired with console 1</p> <p>..... Console 1 extension number</p> <table border="1" style="width: 100%; border-collapse: collapse;"> <thead> <tr> <th style="width: 33%;"></th> <th style="width: 33%; text-align: center;">Console 1</th> <th style="width: 33%; text-align: center;">Telephone paired with console 1</th> </tr> </thead> <tbody> <tr> <td>Extension number</td> <td></td> <td></td> </tr> <tr> <th style="width: 33%;"></th> <th style="width: 33%; text-align: center;">Console 2</th> <th style="width: 33%; text-align: center;">Telephone paired with console 2</th> </tr> <tr> <td>Extension number</td> <td></td> <td></td> </tr> </tbody> </table>		Console 1	Telephone paired with console 1	Extension number				Console 2	Telephone paired with console 2	Extension number																																																																																																																																						
	Console 1	Telephone paired with console 1																																																																																																																																																
Extension number																																																																																																																																																		
	Console 2	Telephone paired with console 2																																																																																																																																																
Extension number																																																																																																																																																		
Dial Mode (Tone/Pulse) Selection	[04]	<p>[NEXT] [SELECT] [MEMORY] [END]</p> <p>..... TONE/PULSE</p> <p>.....until the desired CO number appears</p> <table border="1" style="width: 100%; border-collapse: collapse;"> <thead> <tr> <th style="width: 25%;"></th> <th style="width: 25%; text-align: center;">Default</th> <th colspan="6" style="width: 50%; text-align: center;">To make program change</th> </tr> </thead> <tbody> <tr> <td>CO(s)</td> <td style="text-align: center;">all CO's</td> <td style="text-align: center;">1</td> <td style="text-align: center;">2</td> <td style="text-align: center;">3</td> <td style="text-align: center;">4</td> <td style="text-align: center;">5</td> <td style="text-align: center;">6</td> </tr> <tr> <td>Tone (DTMF) mode</td> <td style="text-align: center;">x</td> <td></td> <td></td> <td></td> <td></td> <td></td> <td></td> </tr> <tr> <td>Pulse mode</td> <td></td> <td></td> <td></td> <td></td> <td></td> <td></td> <td></td> </tr> </tbody> </table>		Default	To make program change						CO(s)	all CO's	1	2	3	4	5	6	Tone (DTMF) mode	x							Pulse mode																																																																																																																							
	Default	To make program change																																																																																																																																																
CO(s)	all CO's	1	2	3	4	5	6																																																																																																																																											
Tone (DTMF) mode	x																																																																																																																																																	
Pulse mode																																																																																																																																																		
Switching Mode (Day/Night Service)	[05]	<p>[SELECT] [MEMORY] [END]</p> <p>..... MANIAUTO</p> <table border="1" style="width: 100%; border-collapse: collapse;"> <thead> <tr> <th style="width: 33%;"></th> <th style="width: 33%; text-align: center;">Default</th> <th style="width: 33%; text-align: center;">To make program change</th> </tr> </thead> <tbody> <tr> <td>Manual</td> <td style="text-align: center;">x</td> <td></td> </tr> <tr> <td>Automatic</td> <td></td> <td></td> </tr> </tbody> </table>		Default	To make program change	Manual	x		Automatic																																																																																																																																									
	Default	To make program change																																																																																																																																																
Manual	x																																																																																																																																																	
Automatic																																																																																																																																																		
Starting Time (Day/Night Service)	[06]	<p>[A] [↔] [B] [↔] [SELECT] [MEMORY] [NEXT] [C] [↔] [D] [↔] [SELECT] [MEMORY] [END]</p> <p>.....minuteAM/PM</p> <p>.....starting time for day service (hour)starting time for night service (hour)</p> <table border="1" style="width: 100%; border-collapse: collapse;"> <thead> <tr> <th style="width: 33%;"></th> <th style="width: 33%; text-align: center;">Default</th> <th style="width: 33%; text-align: center;">To make program change</th> </tr> </thead> <tbody> <tr> <td>Day plan</td> <td style="text-align: center;">9:00 AM</td> <td></td> </tr> <tr> <td>Night plan</td> <td style="text-align: center;">5:00 PM</td> <td></td> </tr> </tbody> </table>		Default	To make program change	Day plan	9:00 AM		Night plan	5:00 PM																																																																																																																																								
	Default	To make program change																																																																																																																																																
Day plan	9:00 AM																																																																																																																																																	
Night plan	5:00 PM																																																																																																																																																	
Flexible Day Outward Dialing Assignment	[07]	<p>[NEXT] [C...H] [MEMORY] [END]</p> <p>.....CO number</p> <p>.....until the desired extension number appears</p> <table border="1" style="width: 100%; border-collapse: collapse;"> <thead> <tr> <th style="width: 10%;"></th> <th style="width: 10%; text-align: center;">Default</th> <th colspan="16" style="width: 80%; text-align: center;">To make program change</th> </tr> </thead> <tbody> <tr> <td>Extensions</td> <td style="text-align: center;">all extensions</td> <td style="text-align: center;">11</td> <td style="text-align: center;">12</td> <td style="text-align: center;">13</td> <td style="text-align: center;">14</td> <td style="text-align: center;">15</td> <td style="text-align: center;">16</td> <td style="text-align: center;">17</td> <td style="text-align: center;">18</td> <td style="text-align: center;">19</td> <td style="text-align: center;">20</td> <td style="text-align: center;">21</td> <td style="text-align: center;">22</td> <td style="text-align: center;">23</td> <td style="text-align: center;">24</td> <td style="text-align: center;">25</td> <td style="text-align: center;">26</td> </tr> <tr> <td>CO 1</td> <td style="text-align: center;">x</td> <td></td> <td></td> <td></td> <td></td> <td></td> <td></td> <td></td> <td></td> <td></td> <td></td> <td></td> <td></td> <td></td> <td></td> <td></td> <td></td> </tr> <tr> <td>CO 2</td> <td style="text-align: center;">x</td> <td></td> <td></td> <td></td> <td></td> <td></td> <td></td> <td></td> <td></td> <td></td> <td></td> <td></td> <td></td> <td></td> <td></td> <td></td> <td></td> </tr> <tr> <td>CO 3</td> <td style="text-align: center;">x</td> <td></td> <td></td> <td></td> <td></td> <td></td> <td></td> <td></td> <td></td> <td></td> <td></td> <td></td> <td></td> <td></td> <td></td> <td></td> <td></td> </tr> <tr> <td>CO 4</td> <td style="text-align: center;">x</td> <td></td> <td></td> <td></td> <td></td> <td></td> <td></td> <td></td> <td></td> <td></td> <td></td> <td></td> <td></td> <td></td> <td></td> <td></td> <td></td> </tr> <tr> <td>CO 5</td> <td style="text-align: center;">x</td> <td></td> <td></td> <td></td> <td></td> <td></td> <td></td> <td></td> <td></td> <td></td> <td></td> <td></td> <td></td> <td></td> <td></td> <td></td> <td></td> </tr> <tr> <td>CO 6</td> <td style="text-align: center;">x</td> <td></td> <td></td> <td></td> <td></td> <td></td> <td></td> <td></td> <td></td> <td></td> <td></td> <td></td> <td></td> <td></td> <td></td> <td></td> <td></td> </tr> </tbody> </table>		Default	To make program change																Extensions	all extensions	11	12	13	14	15	16	17	18	19	20	21	22	23	24	25	26	CO 1	x																	CO 2	x																	CO 3	x																	CO 4	x																	CO 5	x																	CO 6	x																
	Default	To make program change																																																																																																																																																
Extensions	all extensions	11	12	13	14	15	16	17	18	19	20	21	22	23	24	25	26																																																																																																																																	
CO 1	x																																																																																																																																																	
CO 2	x																																																																																																																																																	
CO 3	x																																																																																																																																																	
CO 4	x																																																																																																																																																	
CO 5	x																																																																																																																																																	
CO 6	x																																																																																																																																																	

TO SET	PROGRAM ADDRESS	STEPS REQUIRED TO CHANGE PROGRAM																																																																																																																																																
Flexible Night Outward Dialing Assignment	[08]	<p>[NEXT] [C...H] [MEMORY] [END] CO number until the desired extension number appears</p> <table border="1"> <thead> <tr> <th></th> <th>Default</th> <th colspan="16">To make program change</th> </tr> <tr> <th>Extensions</th> <th>all extensions</th> <th>11</th><th>12</th><th>13</th><th>14</th><th>15</th><th>16</th><th>17</th><th>18</th><th>19</th><th>20</th><th>21</th><th>22</th><th>23</th><th>24</th><th>25</th><th>26</th> </tr> </thead> <tbody> <tr><td>CO 1</td><td>x</td><td></td><td></td><td></td><td></td><td></td><td></td><td></td><td></td><td></td><td></td><td></td><td></td><td></td><td></td><td></td><td></td></tr> <tr><td>CO 2</td><td>x</td><td></td><td></td><td></td><td></td><td></td><td></td><td></td><td></td><td></td><td></td><td></td><td></td><td></td><td></td><td></td><td></td></tr> <tr><td>CO 3</td><td>x</td><td></td><td></td><td></td><td></td><td></td><td></td><td></td><td></td><td></td><td></td><td></td><td></td><td></td><td></td><td></td><td></td></tr> <tr><td>CO 4</td><td>x</td><td></td><td></td><td></td><td></td><td></td><td></td><td></td><td></td><td></td><td></td><td></td><td></td><td></td><td></td><td></td><td></td></tr> <tr><td>CO 5</td><td>x</td><td></td><td></td><td></td><td></td><td></td><td></td><td></td><td></td><td></td><td></td><td></td><td></td><td></td><td></td><td></td><td></td></tr> <tr><td>CO 6</td><td>x</td><td></td><td></td><td></td><td></td><td></td><td></td><td></td><td></td><td></td><td></td><td></td><td></td><td></td><td></td><td></td><td></td></tr> </tbody> </table>		Default	To make program change																Extensions	all extensions	11	12	13	14	15	16	17	18	19	20	21	22	23	24	25	26	CO 1	x																	CO 2	x																	CO 3	x																	CO 4	x																	CO 5	x																	CO 6	x																
	Default	To make program change																																																																																																																																																
Extensions	all extensions	11	12	13	14	15	16	17	18	19	20	21	22	23	24	25	26																																																																																																																																	
CO 1	x																																																																																																																																																	
CO 2	x																																																																																																																																																	
CO 3	x																																																																																																																																																	
CO 4	x																																																																																																																																																	
CO 5	x																																																																																																																																																	
CO 6	x																																																																																																																																																	
Flexible Day Ringing Assignment	[09]	<p>[NEXT] [C...H] [MEMORY] [END] CO number until the desired extension number appears</p> <table border="1"> <thead> <tr> <th></th> <th>Default</th> <th colspan="16">To make program change</th> </tr> <tr> <th>Extensions</th> <th>all extensions</th> <th>11</th><th>12</th><th>13</th><th>14</th><th>15</th><th>16</th><th>17</th><th>18</th><th>19</th><th>20</th><th>21</th><th>22</th><th>23</th><th>24</th><th>25</th><th>26</th> </tr> </thead> <tbody> <tr><td>CO 1</td><td>x</td><td></td><td></td><td></td><td></td><td></td><td></td><td></td><td></td><td></td><td></td><td></td><td></td><td></td><td></td><td></td><td></td></tr> <tr><td>CO 2</td><td>x</td><td></td><td></td><td></td><td></td><td></td><td></td><td></td><td></td><td></td><td></td><td></td><td></td><td></td><td></td><td></td><td></td></tr> <tr><td>CO 3</td><td>x</td><td></td><td></td><td></td><td></td><td></td><td></td><td></td><td></td><td></td><td></td><td></td><td></td><td></td><td></td><td></td><td></td></tr> <tr><td>CO 4</td><td>x</td><td></td><td></td><td></td><td></td><td></td><td></td><td></td><td></td><td></td><td></td><td></td><td></td><td></td><td></td><td></td><td></td></tr> <tr><td>CO 5</td><td>x</td><td></td><td></td><td></td><td></td><td></td><td></td><td></td><td></td><td></td><td></td><td></td><td></td><td></td><td></td><td></td><td></td></tr> <tr><td>CO 6</td><td>x</td><td></td><td></td><td></td><td></td><td></td><td></td><td></td><td></td><td></td><td></td><td></td><td></td><td></td><td></td><td></td><td></td></tr> </tbody> </table>		Default	To make program change																Extensions	all extensions	11	12	13	14	15	16	17	18	19	20	21	22	23	24	25	26	CO 1	x																	CO 2	x																	CO 3	x																	CO 4	x																	CO 5	x																	CO 6	x																
	Default	To make program change																																																																																																																																																
Extensions	all extensions	11	12	13	14	15	16	17	18	19	20	21	22	23	24	25	26																																																																																																																																	
CO 1	x																																																																																																																																																	
CO 2	x																																																																																																																																																	
CO 3	x																																																																																																																																																	
CO 4	x																																																																																																																																																	
CO 5	x																																																																																																																																																	
CO 6	x																																																																																																																																																	
Flexible Night Ringing Assignment	[10]	<p>[NEXT] [C...H] [MEMORY] [END] CO number until the desired extension number appears</p> <table border="1"> <thead> <tr> <th></th> <th>Default</th> <th colspan="16">To make program change</th> </tr> <tr> <th>Extensions</th> <th>all extensions</th> <th>11</th><th>12</th><th>13</th><th>14</th><th>15</th><th>16</th><th>17</th><th>18</th><th>19</th><th>20</th><th>21</th><th>22</th><th>23</th><th>24</th><th>25</th><th>26</th> </tr> </thead> <tbody> <tr><td>CO 1</td><td>x</td><td></td><td></td><td></td><td></td><td></td><td></td><td></td><td></td><td></td><td></td><td></td><td></td><td></td><td></td><td></td><td></td></tr> <tr><td>CO 2</td><td>x</td><td></td><td></td><td></td><td></td><td></td><td></td><td></td><td></td><td></td><td></td><td></td><td></td><td></td><td></td><td></td><td></td></tr> <tr><td>CO 3</td><td>x</td><td></td><td></td><td></td><td></td><td></td><td></td><td></td><td></td><td></td><td></td><td></td><td></td><td></td><td></td><td></td><td></td></tr> <tr><td>CO 4</td><td>x</td><td></td><td></td><td></td><td></td><td></td><td></td><td></td><td></td><td></td><td></td><td></td><td></td><td></td><td></td><td></td><td></td></tr> <tr><td>CO 5</td><td>x</td><td></td><td></td><td></td><td></td><td></td><td></td><td></td><td></td><td></td><td></td><td></td><td></td><td></td><td></td><td></td><td></td></tr> <tr><td>CO 6</td><td>x</td><td></td><td></td><td></td><td></td><td></td><td></td><td></td><td></td><td></td><td></td><td></td><td></td><td></td><td></td><td></td><td></td></tr> </tbody> </table>		Default	To make program change																Extensions	all extensions	11	12	13	14	15	16	17	18	19	20	21	22	23	24	25	26	CO 1	x																	CO 2	x																	CO 3	x																	CO 4	x																	CO 5	x																	CO 6	x																
	Default	To make program change																																																																																																																																																
Extensions	all extensions	11	12	13	14	15	16	17	18	19	20	21	22	23	24	25	26																																																																																																																																	
CO 1	x																																																																																																																																																	
CO 2	x																																																																																																																																																	
CO 3	x																																																																																																																																																	
CO 4	x																																																																																																																																																	
CO 5	x																																																																																																																																																	
CO 6	x																																																																																																																																																	
Toll Restriction—Class Assignment	[11]	<p>[NEXT] [SELECT] [MEMORY] [END] CLASS 1/2/3 until the desired extension number appears</p> <table border="1"> <thead> <tr> <th></th> <th>Default</th> <th colspan="16">To make program change</th> </tr> <tr> <th>Extensions</th> <th>all extensions</th> <th>11</th><th>12</th><th>13</th><th>14</th><th>15</th><th>16</th><th>17</th><th>18</th><th>19</th><th>20</th><th>21</th><th>22</th><th>23</th><th>24</th><th>25</th><th>26</th> </tr> </thead> <tbody> <tr><td>Class 1</td><td>x</td><td></td><td></td><td></td><td></td><td></td><td></td><td></td><td></td><td></td><td></td><td></td><td></td><td></td><td></td><td></td><td></td></tr> <tr><td>Class 2</td><td></td><td></td><td></td><td></td><td></td><td></td><td></td><td></td><td></td><td></td><td></td><td></td><td></td><td></td><td></td><td></td><td></td></tr> <tr><td>Class 3</td><td></td><td></td><td></td><td></td><td></td><td></td><td></td><td></td><td></td><td></td><td></td><td></td><td></td><td></td><td></td><td></td><td></td></tr> </tbody> </table>		Default	To make program change																Extensions	all extensions	11	12	13	14	15	16	17	18	19	20	21	22	23	24	25	26	Class 1	x																	Class 2																		Class 3																																																																							
	Default	To make program change																																																																																																																																																
Extensions	all extensions	11	12	13	14	15	16	17	18	19	20	21	22	23	24	25	26																																																																																																																																	
Class 1	x																																																																																																																																																	
Class 2																																																																																																																																																		
Class 3																																																																																																																																																		
Toll Restriction—Denied Codes Assignment	[12]	<p>[NEXT] [C] [MEMORY] [END] phone number with 7 digits until the desired memory location number appears</p> <table border="1"> <thead> <tr> <th></th> <th colspan="5">Memory location number</th> </tr> <tr> <th></th> <th>00</th><th>01</th><th>02</th><th>03</th><th>04</th> </tr> </thead> <tbody> <tr> <td rowspan="5">Phone number entry</td> <td>05</td><td>06</td><td>07</td><td>08</td><td>09</td> </tr> <tr> <td>10</td><td>11</td><td>12</td><td>13</td><td>14</td> </tr> <tr> <td>15</td><td>16</td><td>17</td><td>18</td><td>19</td> </tr> <tr> <td></td><td></td><td></td><td></td><td></td> </tr> <tr> <td></td><td></td><td></td><td></td><td></td> </tr> </tbody> </table>		Memory location number						00	01	02	03	04	Phone number entry	05	06	07	08	09	10	11	12	13	14	15	16	17	18	19																																																																																																																				
	Memory location number																																																																																																																																																	
	00	01	02	03	04																																																																																																																																													
Phone number entry	05	06	07	08	09																																																																																																																																													
	10	11	12	13	14																																																																																																																																													
	15	16	17	18	19																																																																																																																																													

TO SET	PROGRAM ADDRESS	STEPS REQUIRED TO CHANGE PROGRAM																																																																																																																																																																	
Toll Restriction— Exceptional Code Assignment	[13]	<p>[NEXT] [C] [MEMORY] [END] phone number with 7 digits until the desired memory location number appears</p> <table border="1" data-bbox="398 212 1365 596"> <thead> <tr> <th rowspan="2"></th> <th colspan="5">Memory location number</th> </tr> <tr> <th>00</th> <th>01</th> <th>02</th> <th>03</th> <th>04</th> </tr> </thead> <tbody> <tr> <td rowspan="6">Phone number entry</td> <td></td> <td></td> <td></td> <td></td> <td></td> </tr> <tr> <td>05</td> <td>06</td> <td>07</td> <td>08</td> <td>09</td> </tr> <tr> <td></td> <td></td> <td></td> <td></td> <td></td> </tr> <tr> <td>10</td> <td>11</td> <td>12</td> <td>13</td> <td>14</td> </tr> <tr> <td></td> <td></td> <td></td> <td></td> <td></td> </tr> <tr> <td>15</td> <td>16</td> <td>17</td> <td>18</td> <td>19</td> </tr> </tbody> </table>		Memory location number					00	01	02	03	04	Phone number entry						05	06	07	08	09						10	11	12	13	14						15	16	17	18	19																																																																																																																							
	Memory location number																																																																																																																																																																		
	00	01	02	03	04																																																																																																																																																														
Phone number entry																																																																																																																																																																			
	05	06	07	08	09																																																																																																																																																														
	10	11	12	13	14																																																																																																																																																														
	15	16	17	18	19																																																																																																																																																														
HOST PBX Access Codes Assignment	[14]	<p>[NEXT] [A...D] [MEMORY] [END] Up to four outside access codes each with a maximum of 2 digits until the desired CO numbers appears</p> <table border="1" data-bbox="404 726 1182 911"> <thead> <tr> <th>CO</th> <th colspan="4">Outside access codes of the host PBX</th> </tr> </thead> <tbody> <tr><td>1</td><td></td><td></td><td></td><td></td></tr> <tr><td>2</td><td></td><td></td><td></td><td></td></tr> <tr><td>3</td><td></td><td></td><td></td><td></td></tr> <tr><td>4</td><td></td><td></td><td></td><td></td></tr> <tr><td>5</td><td></td><td></td><td></td><td></td></tr> <tr><td>6</td><td></td><td></td><td></td><td></td></tr> </tbody> </table>	CO	Outside access codes of the host PBX				1					2					3					4					5					6																																																																																																																																		
CO	Outside access codes of the host PBX																																																																																																																																																																		
1																																																																																																																																																																			
2																																																																																																																																																																			
3																																																																																																																																																																			
4																																																																																																																																																																			
5																																																																																																																																																																			
6																																																																																																																																																																			
Preferred CO Line Assignment	[15]	<p>[NEXT] [SELECT] [MEMORY] [END] (none) / CO 1 / CO 2 / CO 3 / CO 4 / CO 5 / CO 6 until the desired extension number appears</p> <table border="1" data-bbox="409 1041 1381 1276"> <thead> <tr> <th rowspan="2">Extensions</th> <th>Default</th> <th colspan="16">To make program change</th> </tr> <tr> <th>all extensions</th> <th>11</th><th>12</th><th>13</th><th>14</th><th>15</th><th>16</th><th>17</th><th>18</th><th>19</th><th>20</th><th>21</th><th>22</th><th>23</th><th>24</th><th>25</th><th>26</th> </tr> </thead> <tbody> <tr> <td>.... (none)</td> <td>x</td> <td></td><td></td><td></td><td></td><td></td><td></td><td></td><td></td><td></td><td></td><td></td><td></td><td></td><td></td><td></td><td></td> </tr> <tr><td>CO 1</td><td></td><td></td><td></td><td></td><td></td><td></td><td></td><td></td><td></td><td></td><td></td><td></td><td></td><td></td><td></td><td></td><td></td></tr> <tr><td>CO 2</td><td></td><td></td><td></td><td></td><td></td><td></td><td></td><td></td><td></td><td></td><td></td><td></td><td></td><td></td><td></td><td></td><td></td></tr> <tr><td>CO 3</td><td></td><td></td><td></td><td></td><td></td><td></td><td></td><td></td><td></td><td></td><td></td><td></td><td></td><td></td><td></td><td></td><td></td></tr> <tr><td>CO 4</td><td></td><td></td><td></td><td></td><td></td><td></td><td></td><td></td><td></td><td></td><td></td><td></td><td></td><td></td><td></td><td></td><td></td></tr> <tr><td>CO 5</td><td></td><td></td><td></td><td></td><td></td><td></td><td></td><td></td><td></td><td></td><td></td><td></td><td></td><td></td><td></td><td></td><td></td></tr> <tr><td>CO 6</td><td></td><td></td><td></td><td></td><td></td><td></td><td></td><td></td><td></td><td></td><td></td><td></td><td></td><td></td><td></td><td></td><td></td></tr> </tbody> </table>	Extensions	Default	To make program change																all extensions	11	12	13	14	15	16	17	18	19	20	21	22	23	24	25	26 (none)	x																	CO 1																		CO 2																		CO 3																		CO 4																		CO 5																		CO 6																	
Extensions	Default	To make program change																																																																																																																																																																	
	all extensions	11	12	13	14	15	16	17	18	19	20	21	22	23	24	25	26																																																																																																																																																		
.... (none)	x																																																																																																																																																																		
CO 1																																																																																																																																																																			
CO 2																																																																																																																																																																			
CO 3																																																																																																																																																																			
CO 4																																																																																																																																																																			
CO 5																																																																																																																																																																			
CO 6																																																																																																																																																																			
Programmable Call Waiting	[16]	<p>[NEXT] [SELECT] [MEMORY] [END] EXT.-OFF, CO-OFF / EXT.-ON, CO-OFF / EXT.-OFF, CO-ON / EXT.-ON, CO-ON until the desired extension number appears</p> <table border="1" data-bbox="417 1409 1386 1566"> <thead> <tr> <th rowspan="2">Extensions</th> <th>Default</th> <th colspan="16">To make program change</th> </tr> <tr> <th>all extensions</th> <th>11</th><th>12</th><th>13</th><th>14</th><th>15</th><th>16</th><th>17</th><th>18</th><th>19</th><th>20</th><th>21</th><th>22</th><th>23</th><th>24</th><th>25</th><th>26</th> </tr> </thead> <tbody> <tr> <td>EXT.-OFF, CO-OFF</td> <td>x</td> <td></td><td></td><td></td><td></td><td></td><td></td><td></td><td></td><td></td><td></td><td></td><td></td><td></td><td></td><td></td><td></td> </tr> <tr><td>EXT.-ON, CO-OFF</td><td></td><td></td><td></td><td></td><td></td><td></td><td></td><td></td><td></td><td></td><td></td><td></td><td></td><td></td><td></td><td></td><td></td></tr> <tr><td>EXT.-OFF, CO-ON</td><td></td><td></td><td></td><td></td><td></td><td></td><td></td><td></td><td></td><td></td><td></td><td></td><td></td><td></td><td></td><td></td><td></td></tr> <tr><td>EXT.-ON, CO-ON</td><td></td><td></td><td></td><td></td><td></td><td></td><td></td><td></td><td></td><td></td><td></td><td></td><td></td><td></td><td></td><td></td><td></td></tr> </tbody> </table>	Extensions	Default	To make program change																all extensions	11	12	13	14	15	16	17	18	19	20	21	22	23	24	25	26	EXT.-OFF, CO-OFF	x																	EXT.-ON, CO-OFF																		EXT.-OFF, CO-ON																		EXT.-ON, CO-ON																																																																							
Extensions	Default	To make program change																																																																																																																																																																	
	all extensions	11	12	13	14	15	16	17	18	19	20	21	22	23	24	25	26																																																																																																																																																		
EXT.-OFF, CO-OFF	x																																																																																																																																																																		
EXT.-ON, CO-OFF																																																																																																																																																																			
EXT.-OFF, CO-ON																																																																																																																																																																			
EXT.-ON, CO-ON																																																																																																																																																																			

TO SET	PROGRAM ADDRESS	STEPS REQUIRED TO CHANGE PROGRAM																																																																																				
Duration Time Count Start Mode	[23]	<p>[SELECT] [MEMORY] [END] INSTANTLY/SS AFTER DIAL/IOS AFTER DIAL</p> <table border="1" data-bbox="393 201 1172 304"> <thead> <tr> <th></th> <th>Default</th> <th>To make program change</th> </tr> </thead> <tbody> <tr> <td>Instantly</td> <td></td> <td></td> </tr> <tr> <td>SS after dial</td> <td>x</td> <td></td> </tr> <tr> <td>IOS after dial</td> <td></td> <td></td> </tr> </tbody> </table>		Default	To make program change	Instantly			SS after dial	x		IOS after dial																																																																										
	Default	To make program change																																																																																				
Instantly																																																																																						
SS after dial	x																																																																																					
IOS after dial																																																																																						
SMDR Communication Parameters	[24]	<p>(Carriage return for a new line) [SELECT] [MEMORY] CR+LF/CR</p> <table border="1" data-bbox="393 411 1172 489"> <thead> <tr> <th></th> <th>Default</th> <th>To make program change</th> </tr> </thead> <tbody> <tr> <td>CR+LF</td> <td>x</td> <td></td> </tr> <tr> <td>CR</td> <td></td> <td></td> </tr> </tbody> </table> <p>(Baud rate) [NEXT] [SELECT] [MEMORY] 110B/150B/300B/600B/1200B/2400B/4800B/9600B</p> <table border="1" data-bbox="393 604 1370 682"> <thead> <tr> <th></th> <th>110B</th> <th>150B</th> <th>300B</th> <th>600B</th> <th>1200B</th> <th>2400B</th> <th>4800B</th> <th>9600B</th> </tr> </thead> <tbody> <tr> <td>Default</td> <td></td> <td></td> <td></td> <td></td> <td>x</td> <td></td> <td></td> <td></td> </tr> <tr> <td>To make program change</td> <td></td> <td></td> <td></td> <td></td> <td></td> <td></td> <td></td> <td></td> </tr> </tbody> </table> <p>(Word length) [NEXT] [SELECT] [MEMORY] 7 BITS/8 BITS</p> <table border="1" data-bbox="393 800 1177 877"> <thead> <tr> <th></th> <th>Default</th> <th>To make program change</th> </tr> </thead> <tbody> <tr> <td>7 BITS</td> <td>x</td> <td></td> </tr> <tr> <td>8 BITS</td> <td></td> <td></td> </tr> </tbody> </table> <p>(Parity) [NEXT] [SELECT] [MEMORY] NONE/MARK/SPACE/EVEN/ODD</p> <table border="1" data-bbox="393 995 1182 1073"> <thead> <tr> <th></th> <th>None</th> <th>Mark</th> <th>Space</th> <th>Even</th> <th>Odd</th> </tr> </thead> <tbody> <tr> <td>Default</td> <td></td> <td>x</td> <td></td> <td></td> <td></td> </tr> <tr> <td>To make program change</td> <td></td> <td></td> <td></td> <td></td> <td></td> </tr> </tbody> </table> <p>(Stop bit length) [NEXT] [SELECT] [MEMORY] 1 BIT/2 BITS</p> <table border="1" data-bbox="393 1190 1182 1268"> <thead> <tr> <th></th> <th>Default</th> <th>To make program change</th> </tr> </thead> <tbody> <tr> <td>1 BIT</td> <td>x</td> <td></td> </tr> <tr> <td>2 BITS</td> <td></td> <td></td> </tr> </tbody> </table> <p>(Page length) [NEXT] [AB] [MEMORY] 4 through 99 lines</p> <table border="1" data-bbox="393 1386 1186 1444"> <thead> <tr> <th></th> <th>Default</th> <th>To make program change</th> </tr> </thead> <tbody> <tr> <td>Lines per page</td> <td>66</td> <td></td> </tr> </tbody> </table> <p>(Skip perforation) [NEXT] [AB] [MEMORY] [END] 0 through 95 lines</p> <table border="1" data-bbox="393 1562 1186 1619"> <thead> <tr> <th></th> <th>Default</th> <th>To make program change</th> </tr> </thead> <tbody> <tr> <td>Skipping lines</td> <td>0</td> <td></td> </tr> </tbody> </table>		Default	To make program change	CR+LF	x		CR				110B	150B	300B	600B	1200B	2400B	4800B	9600B	Default					x				To make program change										Default	To make program change	7 BITS	x		8 BITS				None	Mark	Space	Even	Odd	Default		x				To make program change							Default	To make program change	1 BIT	x		2 BITS				Default	To make program change	Lines per page	66			Default	To make program change	Skipping lines	0	
	Default	To make program change																																																																																				
CR+LF	x																																																																																					
CR																																																																																						
	110B	150B	300B	600B	1200B	2400B	4800B	9600B																																																																														
Default					x																																																																																	
To make program change																																																																																						
	Default	To make program change																																																																																				
7 BITS	x																																																																																					
8 BITS																																																																																						
	None	Mark	Space	Even	Odd																																																																																	
Default		x																																																																																				
To make program change																																																																																						
	Default	To make program change																																																																																				
1 BIT	x																																																																																					
2 BITS																																																																																						
	Default	To make program change																																																																																				
Lines per page	66																																																																																					
	Default	To make program change																																																																																				
Skipping lines	0																																																																																					
System Data Dump	[25]	<p>•START OUTPUT [MEMORY] [END] START</p> <p>•STOP OUTPUT [SELECT] [MEMORY] [END] until the STOP appears</p>																																																																																				

TO SET	PROGRAM ADDRESS	STEPS REQUIRED TO CHANGE PROGRAM																																																																							
SMDR Incoming/ Outgoing Selection	[26]	<p>[SELECT] [MEMORY] [NEXT] [SELECT] [MEMORY] [END] OUTGOING: ON/OFF/TOLL.....INCOMING: ON/OFF</p> <table border="1"> <thead> <tr> <th rowspan="2"></th> <th colspan="3">Outgoing</th> <th colspan="2">Incoming</th> </tr> <tr> <th>ON</th> <th>OFF</th> <th>TOLL</th> <th>ON</th> <th>OFF</th> </tr> </thead> <tbody> <tr> <td>Default</td> <td>x</td> <td></td> <td></td> <td>x</td> <td></td> </tr> <tr> <td>To make program change</td> <td></td> <td></td> <td></td> <td></td> <td></td> </tr> </tbody> </table>		Outgoing			Incoming		ON	OFF	TOLL	ON	OFF	Default	x			x		To make program change																																																					
	Outgoing			Incoming																																																																					
	ON	OFF	TOLL	ON	OFF																																																																				
Default	x			x																																																																					
To make program change																																																																									
Automatic Answering (Automatic/ Manual) Selection	[27]	<p>[NEXT] [SELECT] [MEMORY] [END] AUTO ANSWER/MAN ANSWER until the desired extension number appears</p> <table border="1"> <thead> <tr> <th rowspan="2"></th> <th>Default</th> <th colspan="16">To make program change</th> </tr> <tr> <th>all extensions</th> <th>11</th> <th>12</th> <th>13</th> <th>14</th> <th>15</th> <th>16</th> <th>17</th> <th>18</th> <th>19</th> <th>20</th> <th>21</th> <th>22</th> <th>23</th> <th>24</th> <th>25</th> <th>26</th> </tr> </thead> <tbody> <tr> <td>Automatic</td> <td>x</td> <td></td> <td></td> <td></td> <td></td> <td></td> <td></td> <td></td> <td></td> <td></td> <td></td> <td></td> <td></td> <td></td> <td></td> <td></td> <td></td> </tr> <tr> <td>Manual</td> <td></td> <td></td> <td></td> <td></td> <td></td> <td></td> <td></td> <td></td> <td></td> <td></td> <td></td> <td></td> <td></td> <td></td> <td></td> <td></td> <td></td> </tr> </tbody> </table>		Default	To make program change																all extensions	11	12	13	14	15	16	17	18	19	20	21	22	23	24	25	26	Automatic	x																	Manual																	
	Default	To make program change																																																																							
	all extensions	11	12	13	14	15	16	17	18	19	20	21	22	23	24	25	26																																																								
Automatic	x																																																																								
Manual																																																																									
Hold Recall Time Set	[28]	<p>[SELECT] [MEMORY] [END] 30SEC/1 MIN/2 MIN/3 MIN/4 MIN/5 MIN/DISABLE</p> <table border="1"> <thead> <tr> <th></th> <th>30 seconds</th> <th>1 minute</th> <th>2 minutes</th> <th>3 minutes</th> <th>4 minutes</th> <th>5 minutes</th> <th>Disable</th> </tr> </thead> <tbody> <tr> <td>Default</td> <td>x</td> <td></td> <td></td> <td></td> <td></td> <td></td> <td></td> </tr> <tr> <td>To make program change</td> <td></td> <td></td> <td></td> <td></td> <td></td> <td></td> <td></td> </tr> </tbody> </table>		30 seconds	1 minute	2 minutes	3 minutes	4 minutes	5 minutes	Disable	Default	x							To make program change																																																						
	30 seconds	1 minute	2 minutes	3 minutes	4 minutes	5 minutes	Disable																																																																		
Default	x																																																																								
To make program change																																																																									
Programmable External Paging Access Tone	[29]	<p>[SELECT] [MEMORY] [END] ENABLE/DISABLE</p> <table border="1"> <thead> <tr> <th></th> <th>Default</th> <th>To make program change</th> </tr> </thead> <tbody> <tr> <td>Enable</td> <td>x</td> <td></td> </tr> <tr> <td>Disable</td> <td></td> <td></td> </tr> </tbody> </table>		Default	To make program change	Enable	x		Disable																																																																
	Default	To make program change																																																																							
Enable	x																																																																								
Disable																																																																									
Programmable Secret Speed Dial	[30]	<p>[SELECT] [MEMORY] [END] NO SECRET/SECRET</p> <table border="1"> <thead> <tr> <th></th> <th>Default</th> <th>To make program change</th> </tr> </thead> <tbody> <tr> <td>No secret</td> <td>x</td> <td></td> </tr> <tr> <td>Secret</td> <td></td> <td></td> </tr> </tbody> </table>		Default	To make program change	No secret	x		Secret																																																																
	Default	To make program change																																																																							
No secret	x																																																																								
Secret																																																																									
Hookswitch Flash Timing	[31]	<p>[NEXT] [SELECT] [MEMORY] [END] 300 MS/600 MS/900 MS until the desired CO number appears</p> <table border="1"> <thead> <tr> <th></th> <th>Default</th> <th colspan="6">To make program change</th> </tr> <tr> <th>CO(s)</th> <th>all CO's</th> <th>1</th> <th>2</th> <th>3</th> <th>4</th> <th>5</th> <th>6</th> </tr> </thead> <tbody> <tr> <td>300 msec</td> <td></td> <td></td> <td></td> <td></td> <td></td> <td></td> <td></td> </tr> <tr> <td>600 msec</td> <td>x</td> <td></td> <td></td> <td></td> <td></td> <td></td> <td></td> </tr> <tr> <td>900 msec</td> <td></td> <td></td> <td></td> <td></td> <td></td> <td></td> <td></td> </tr> </tbody> </table>		Default	To make program change						CO(s)	all CO's	1	2	3	4	5	6	300 msec								600 msec	x							900 msec																																						
	Default	To make program change																																																																							
CO(s)	all CO's	1	2	3	4	5	6																																																																		
300 msec																																																																									
600 msec	x																																																																								
900 msec																																																																									
Disconnect Time	[32]	<p>[NEXT] [SELECT] [MEMORY] [END] 1.5 SEC/4.0 SEC until the desired CO number appears</p> <table border="1"> <thead> <tr> <th></th> <th>Default</th> <th colspan="6">To make program change</th> </tr> <tr> <th>CO(s)</th> <th>all CO's</th> <th>1</th> <th>2</th> <th>3</th> <th>4</th> <th>5</th> <th>6</th> </tr> </thead> <tbody> <tr> <td>1.5 sec</td> <td>x</td> <td></td> <td></td> <td></td> <td></td> <td></td> <td></td> </tr> <tr> <td>4.0 sec</td> <td></td> <td></td> <td></td> <td></td> <td></td> <td></td> <td></td> </tr> </tbody> </table>		Default	To make program change						CO(s)	all CO's	1	2	3	4	5	6	1.5 sec	x							4.0 sec																																														
	Default	To make program change																																																																							
CO(s)	all CO's	1	2	3	4	5	6																																																																		
1.5 sec	x																																																																								
4.0 sec																																																																									
Calling Party Control (CPC) Signal	[33]	<p>[NEXT] [SELECT] [MEMORY] [END] ENABLE/DISABLE until the desired CO number appears</p> <table border="1"> <thead> <tr> <th></th> <th>Default</th> <th colspan="6">To make program change</th> </tr> <tr> <th>CO(s)</th> <th>all CO's</th> <th>1</th> <th>2</th> <th>3</th> <th>4</th> <th>5</th> <th>6</th> </tr> </thead> <tbody> <tr> <td>Enable</td> <td>x</td> <td></td> <td></td> <td></td> <td></td> <td></td> <td></td> </tr> <tr> <td>Disable</td> <td></td> <td></td> <td></td> <td></td> <td></td> <td></td> <td></td> </tr> </tbody> </table>		Default	To make program change						CO(s)	all CO's	1	2	3	4	5	6	Enable	x							Disable																																														
	Default	To make program change																																																																							
CO(s)	all CO's	1	2	3	4	5	6																																																																		
Enable	x																																																																								
Disable																																																																									

TO SET	PROGRAM ADDRESS	STEPS REQUIRED TO CHANGE PROGRAM																																																																																																																																			
DSS Button Mode	[34]	<p>[SELECT] [MEMORY] [END] WITHOUT TRANSFER/WITH TRANSFER</p> <table border="1"> <thead> <tr> <th></th> <th>Default</th> <th colspan="2">To make program change</th> </tr> </thead> <tbody> <tr> <td>Without transfer</td> <td>x</td> <td></td> <td></td> </tr> <tr> <td>With transfer</td> <td></td> <td></td> <td></td> </tr> </tbody> </table>		Default	To make program change		Without transfer	x			With transfer																																																																																																																										
	Default	To make program change																																																																																																																																			
Without transfer	x																																																																																																																																				
With transfer																																																																																																																																					
DTMF Receiver Check	[35]	<p>[NEXT] [SELECT] [MEMORY] [END] ENABLE/DISABLE until the desired DTMF receiver appears</p> <table border="1"> <thead> <tr> <th></th> <th>Default</th> <th colspan="2">To make program change</th> </tr> </thead> <tbody> <tr> <td>DTMF receiver</td> <td>1, 2</td> <td>1</td> <td>2</td> </tr> <tr> <td>Enable</td> <td>x</td> <td></td> <td></td> </tr> <tr> <td>Disable</td> <td></td> <td></td> <td></td> </tr> </tbody> </table>		Default	To make program change		DTMF receiver	1, 2	1	2	Enable	x			Disable																																																																																																																						
	Default	To make program change																																																																																																																																			
DTMF receiver	1, 2	1	2																																																																																																																																		
Enable	x																																																																																																																																				
Disable																																																																																																																																					
Transfer Recall Time	[36]	<p>[SELECT] [MEMORY] [END] 30 SEC/2 MIN</p> <table border="1"> <thead> <tr> <th></th> <th>Default</th> <th colspan="2">To make program change</th> </tr> </thead> <tbody> <tr> <td>30 seconds</td> <td>x</td> <td></td> <td></td> </tr> <tr> <td>2 minutes</td> <td></td> <td></td> <td></td> </tr> </tbody> </table>		Default	To make program change		30 seconds	x			2 minutes																																																																																																																										
	Default	To make program change																																																																																																																																			
30 seconds	x																																																																																																																																				
2 minutes																																																																																																																																					
Standard Telephone Connection with Proprietary Telephone	[37]	<p>[NEXT] [SELECT] [MEMORY] [END] ENABLE/DISABLE until the desired extension number appears</p> <table border="1"> <thead> <tr> <th></th> <th>Default</th> <th colspan="26">To make program change</th> </tr> </thead> <tbody> <tr> <td>Extensions</td> <td>all extensions</td> <td>11</td><td>12</td><td>13</td><td>14</td><td>15</td><td>16</td><td>17</td><td>18</td><td>19</td><td>20</td><td>21</td><td>22</td><td>23</td><td>24</td><td>25</td><td>26</td> <td></td><td></td><td></td><td></td><td></td><td></td><td></td><td></td><td></td><td></td><td></td><td></td><td></td><td></td><td></td><td></td><td></td> </tr> <tr> <td>Disable</td> <td>x</td> <td></td><td></td><td></td><td></td><td></td><td></td><td></td><td></td><td></td><td></td><td></td><td></td><td></td><td></td><td></td><td></td> <td></td><td></td><td></td><td></td><td></td><td></td><td></td><td></td><td></td><td></td><td></td><td></td><td></td><td></td><td></td><td></td> </tr> <tr> <td>Enable</td> <td></td> <td></td><td></td><td></td><td></td><td></td><td></td><td></td><td></td><td></td><td></td><td></td><td></td><td></td><td></td><td></td><td></td> <td></td><td></td><td></td><td></td><td></td><td></td><td></td><td></td><td></td><td></td><td></td><td></td><td></td><td></td><td></td><td></td> </tr> </tbody> </table>		Default	To make program change																										Extensions	all extensions	11	12	13	14	15	16	17	18	19	20	21	22	23	24	25	26																		Disable	x																																	Enable																																	
	Default	To make program change																																																																																																																																			
Extensions	all extensions	11	12	13	14	15	16	17	18	19	20	21	22	23	24	25	26																																																																																																																				
Disable	x																																																																																																																																				
Enable																																																																																																																																					
F1/SAVE Selection	[38]	<p>[NEXT] [SELECT] [MEMORY] [END] FEATURE KEY/SAVE KEY until the desired extension number appears</p> <table border="1"> <thead> <tr> <th></th> <th>Default</th> <th colspan="26">To make program change</th> </tr> </thead> <tbody> <tr> <td>Extensions</td> <td>all extensions</td> <td>11</td><td>12</td><td>13</td><td>14</td><td>15</td><td>16</td><td>17</td><td>18</td><td>19</td><td>20</td><td>21</td><td>22</td><td>23</td><td>24</td><td>25</td><td>26</td> <td></td><td></td><td></td><td></td><td></td><td></td><td></td><td></td><td></td><td></td><td></td><td></td><td></td><td></td><td></td><td></td> </tr> <tr> <td>Feature key</td> <td>x</td> <td></td><td></td><td></td><td></td><td></td><td></td><td></td><td></td><td></td><td></td><td></td><td></td><td></td><td></td><td></td><td></td> <td></td><td></td><td></td><td></td><td></td><td></td><td></td><td></td><td></td><td></td><td></td><td></td><td></td><td></td><td></td><td></td> </tr> <tr> <td>Save key</td> <td></td> <td></td><td></td><td></td><td></td><td></td><td></td><td></td><td></td><td></td><td></td><td></td><td></td><td></td><td></td><td></td><td></td> <td></td><td></td><td></td><td></td><td></td><td></td><td></td><td></td><td></td><td></td><td></td><td></td><td></td><td></td><td></td><td></td> </tr> </tbody> </table>		Default	To make program change																										Extensions	all extensions	11	12	13	14	15	16	17	18	19	20	21	22	23	24	25	26																	Feature key	x																																	Save key																																		
	Default	To make program change																																																																																																																																			
Extensions	all extensions	11	12	13	14	15	16	17	18	19	20	21	22	23	24	25	26																																																																																																																				
Feature key	x																																																																																																																																				
Save key																																																																																																																																					
F3/FWD Selection	[39]	<p>[NEXT] [SELECT] [MEMORY] [END] FEATURE KEY/FWD, DND KEY until the desired extension number appears</p> <table border="1"> <thead> <tr> <th></th> <th>Default</th> <th colspan="26">To make program change</th> </tr> </thead> <tbody> <tr> <td>Extensions</td> <td>all extensions</td> <td>11</td><td>12</td><td>13</td><td>14</td><td>15</td><td>16</td><td>17</td><td>18</td><td>19</td><td>20</td><td>21</td><td>22</td><td>23</td><td>24</td><td>25</td><td>26</td> <td></td><td></td><td></td><td></td><td></td><td></td><td></td><td></td><td></td><td></td><td></td><td></td><td></td><td></td><td></td><td></td> </tr> <tr> <td>Feature key</td> <td>x</td> <td></td><td></td><td></td><td></td><td></td><td></td><td></td><td></td><td></td><td></td><td></td><td></td><td></td><td></td><td></td><td></td> <td></td><td></td><td></td><td></td><td></td><td></td><td></td><td></td><td></td><td></td><td></td><td></td><td></td><td></td><td></td><td></td> </tr> <tr> <td>FWD/DND key</td> <td></td> <td></td><td></td><td></td><td></td><td></td><td></td><td></td><td></td><td></td><td></td><td></td><td></td><td></td><td></td><td></td><td></td> <td></td><td></td><td></td><td></td><td></td><td></td><td></td><td></td><td></td><td></td><td></td><td></td><td></td><td></td><td></td><td></td> </tr> </tbody> </table>		Default	To make program change																										Extensions	all extensions	11	12	13	14	15	16	17	18	19	20	21	22	23	24	25	26																	Feature key	x																																	FWD/DND key																																		
	Default	To make program change																																																																																																																																			
Extensions	all extensions	11	12	13	14	15	16	17	18	19	20	21	22	23	24	25	26																																																																																																																				
Feature key	x																																																																																																																																				
FWD/DND key																																																																																																																																					
Programmable Executive Override	[40]	<p>[NEXT] [SELECT] [MEMORY] [END] ENABLE/DISABLE until the desired extension number appears</p> <table border="1"> <thead> <tr> <th></th> <th>Default</th> <th colspan="26">To make program change</th> </tr> </thead> <tbody> <tr> <td>Extensions</td> <td>all extensions</td> <td>11</td><td>12</td><td>13</td><td>14</td><td>15</td><td>16</td><td>17</td><td>18</td><td>19</td><td>20</td><td>21</td><td>22</td><td>23</td><td>24</td><td>25</td><td>26</td> <td></td><td></td><td></td><td></td><td></td><td></td><td></td><td></td><td></td><td></td><td></td><td></td><td></td><td></td><td></td><td></td> </tr> <tr> <td>Disable</td> <td>x</td> <td></td><td></td><td></td><td></td><td></td><td></td><td></td><td></td><td></td><td></td><td></td><td></td><td></td><td></td><td></td><td></td> <td></td><td></td><td></td><td></td><td></td><td></td><td></td><td></td><td></td><td></td><td></td><td></td><td></td><td></td><td></td><td></td> </tr> <tr> <td>Enable</td> <td></td> <td></td><td></td><td></td><td></td><td></td><td></td><td></td><td></td><td></td><td></td><td></td><td></td><td></td><td></td><td></td><td></td> <td></td><td></td><td></td><td></td><td></td><td></td><td></td><td></td><td></td><td></td><td></td><td></td><td></td><td></td><td></td><td></td> </tr> </tbody> </table>		Default	To make program change																										Extensions	all extensions	11	12	13	14	15	16	17	18	19	20	21	22	23	24	25	26																	Disable	x																																	Enable																																		
	Default	To make program change																																																																																																																																			
Extensions	all extensions	11	12	13	14	15	16	17	18	19	20	21	22	23	24	25	26																																																																																																																				
Disable	x																																																																																																																																				
Enable																																																																																																																																					

TO SET	PROGRAM ADDRESS	STEPS REQUIRED TO CHANGE PROGRAM																																																																																																																																																
Automatic Designated CO Line Access	[41]	<p>[NEXT] [C...H] [MEMORY] [END] dial the CO number until the desired extension number appears</p> <table border="1"> <thead> <tr> <th></th> <th>Default</th> <th colspan="16">To make program change</th> </tr> <tr> <th>Extensions</th> <th>all extensions</th> <th>11</th><th>12</th><th>13</th><th>14</th><th>15</th><th>16</th><th>17</th><th>18</th><th>19</th><th>20</th><th>21</th><th>22</th><th>23</th><th>24</th><th>25</th><th>26</th> </tr> </thead> <tbody> <tr> <td>CO 1</td> <td>x</td> <td></td><td></td><td></td><td></td><td></td><td></td><td></td><td></td><td></td><td></td><td></td><td></td><td></td><td></td><td></td><td></td> </tr> <tr> <td>CO 2</td> <td>x</td> <td></td><td></td><td></td><td></td><td></td><td></td><td></td><td></td><td></td><td></td><td></td><td></td><td></td><td></td><td></td><td></td> </tr> <tr> <td>CO 3</td> <td>x</td> <td></td><td></td><td></td><td></td><td></td><td></td><td></td><td></td><td></td><td></td><td></td><td></td><td></td><td></td><td></td><td></td> </tr> <tr> <td>CO 4</td> <td>x</td> <td></td><td></td><td></td><td></td><td></td><td></td><td></td><td></td><td></td><td></td><td></td><td></td><td></td><td></td><td></td><td></td> </tr> <tr> <td>CO 5</td> <td>x</td> <td></td><td></td><td></td><td></td><td></td><td></td><td></td><td></td><td></td><td></td><td></td><td></td><td></td><td></td><td></td><td></td> </tr> <tr> <td>CO 6</td> <td>x</td> <td></td><td></td><td></td><td></td><td></td><td></td><td></td><td></td><td></td><td></td><td></td><td></td><td></td><td></td><td></td><td></td> </tr> </tbody> </table>		Default	To make program change																Extensions	all extensions	11	12	13	14	15	16	17	18	19	20	21	22	23	24	25	26	CO 1	x																	CO 2	x																	CO 3	x																	CO 4	x																	CO 5	x																	CO 6	x																
	Default	To make program change																																																																																																																																																
Extensions	all extensions	11	12	13	14	15	16	17	18	19	20	21	22	23	24	25	26																																																																																																																																	
CO 1	x																																																																																																																																																	
CO 2	x																																																																																																																																																	
CO 3	x																																																																																																																																																	
CO 4	x																																																																																																																																																	
CO 5	x																																																																																																																																																	
CO 6	x																																																																																																																																																	
Programmable Call Waiting Tone	[42]	<p>[NEXT] [SELECT] [MEMORY] [END] TONE 1/TONE 2 until the desired extension number appears</p> <table border="1"> <thead> <tr> <th></th> <th>Default</th> <th colspan="16">To make program change</th> </tr> <tr> <th>Extensions</th> <th>all extensions</th> <th>11</th><th>12</th><th>13</th><th>14</th><th>15</th><th>16</th><th>17</th><th>18</th><th>19</th><th>20</th><th>21</th><th>22</th><th>23</th><th>24</th><th>25</th><th>26</th> </tr> </thead> <tbody> <tr> <td>Tone 1</td> <td>x</td> <td></td><td></td><td></td><td></td><td></td><td></td><td></td><td></td><td></td><td></td><td></td><td></td><td></td><td></td><td></td><td></td> </tr> <tr> <td>Tone 2</td> <td></td> <td></td><td></td><td></td><td></td><td></td><td></td><td></td><td></td><td></td><td></td><td></td><td></td><td></td><td></td><td></td><td></td> </tr> </tbody> </table>		Default	To make program change																Extensions	all extensions	11	12	13	14	15	16	17	18	19	20	21	22	23	24	25	26	Tone 1	x																	Tone 2																																																																																									
	Default	To make program change																																																																																																																																																
Extensions	all extensions	11	12	13	14	15	16	17	18	19	20	21	22	23	24	25	26																																																																																																																																	
Tone 1	x																																																																																																																																																	
Tone 2																																																																																																																																																		
Door Opener Assignment	[43]	<p>[NEXT] [SELECT] [MEMORY] [END] D-OPENER 1, 2/11... (not assigned) until the desired extension number appears</p> <table border="1"> <thead> <tr> <th></th> <th>Default</th> <th colspan="16">To make program change</th> </tr> <tr> <th>Extensions</th> <th>all extensions</th> <th>11</th><th>12</th><th>13</th><th>14</th><th>15</th><th>16</th><th>17</th><th>18</th><th>19</th><th>20</th><th>21</th><th>22</th><th>23</th><th>24</th><th>25</th><th>26</th> </tr> </thead> <tbody> <tr> <td>not assigned</td> <td></td> <td></td><td></td><td></td><td></td><td></td><td></td><td></td><td></td><td></td><td></td><td></td><td></td><td></td><td></td><td></td><td></td> </tr> <tr> <td>Door opener 1</td> <td>x</td> <td></td><td></td><td></td><td></td><td></td><td></td><td></td><td></td><td></td><td></td><td></td><td></td><td></td><td></td><td></td><td></td> </tr> <tr> <td>Door opener 2</td> <td>x</td> <td></td><td></td><td></td><td></td><td></td><td></td><td></td><td></td><td></td><td></td><td></td><td></td><td></td><td></td><td></td><td></td> </tr> </tbody> </table>		Default	To make program change																Extensions	all extensions	11	12	13	14	15	16	17	18	19	20	21	22	23	24	25	26	not assigned																		Door opener 1	x																	Door opener 2	x																																																																						
	Default	To make program change																																																																																																																																																
Extensions	all extensions	11	12	13	14	15	16	17	18	19	20	21	22	23	24	25	26																																																																																																																																	
not assigned																																																																																																																																																		
Door opener 1	x																																																																																																																																																	
Door opener 2	x																																																																																																																																																	
Carrier Codes Assingment	[45]	<p>[NEXT] [C] [MEMORY] [END] carrier code with up to 10 digits until the desired locaiton number appears</p> <table border="1"> <thead> <tr> <th>location number</th> <th>carrier code</th> </tr> </thead> <tbody> <tr> <td>00</td> <td></td> </tr> <tr> <td>01</td> <td></td> </tr> <tr> <td>02</td> <td></td> </tr> <tr> <td>03</td> <td></td> </tr> <tr> <td>04</td> <td></td> </tr> </tbody> </table>	location number	carrier code	00		01		02		03		04																																																																																																																																					
location number	carrier code																																																																																																																																																	
00																																																																																																																																																		
01																																																																																																																																																		
02																																																																																																																																																		
03																																																																																																																																																		
04																																																																																																																																																		
System Clear	[99]	[MEMORY] [END]																																																																																																																																																

Panasonic Company
 Division of Matsushita Electric Corporation of America
 One Panasonic Way, Secaucus, New Jersey 07094

Panasonic Company (West) of America
 Division of Matsushita Electric Corporation of America
 6550 Katella Avenue, Cypress, California 90630

Panasonic Sales Company ("PSC")
 Division of Matsushita Electric of Puerto Rico, Inc.
 San Gabriel Industrial Park, 65th Infantry Avenue, KM 9.5, Carolina, P.R. 00630

STATION USER GUIDE

For touch tone and rotary telephone

Panasonic
EASA-PHONE

KX-T61610

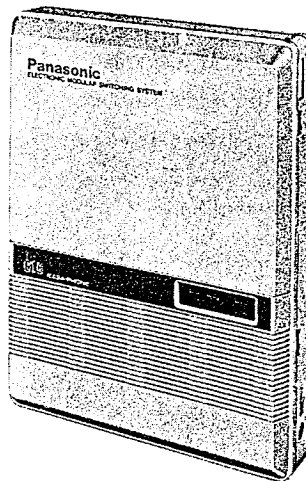

See this Station User Guide when you use a touch tone or rotary telephone as an extension.

Basic Operation

Detailed Operation

Contents

Basic Operation

Quick Reference Card	2
To Make Calls	
Inter Office Calling (Intercom)	6
Outward Dialing	6
Speed Dialing	7
Calling Doorphone	7
When a Line is Busy	
Automatic Call Back Busy (Camp-on)	8
Busy Station Signaling ..	9
Last Number Redial	9
To Receive Calls	
Answer	10
Dial Call Pickup	10
Directed Call Pickup	10
Call Park Retrieve	11
Doorphone	11
While Having a Conversation	
Call on Hold	12
Call Splitting	12
Conference	13
Call Waiting	13
Call Transfer	14

Detailed Operation

Use of Other Features	
Paging All Extensions	15
Paging Group	15
Paging-External	16
Paging and Transfer	16
Paging-Answer	17
Intercom Alerting Mode ..	17
External Feature Access..	18
Pulse/Tone Conversion...	19
Account Code	20
Station Programming	
Call Forwarding	22
Dial Call Pickup Deny	23
Do not Disturb	24
Data Line Security	25
Pickup Dial	26
Station Program Clear ..	28

Quick Reference Card

TO MAKE CALLS

- Lift the handset first.
- After finishing your conversation, hang up the handset.

INTER OFFICE CALLING (Intercom)	Dial extension number (11 through 26)		
OUTWARD DIALING Automatic Line Access	WXY 9	Dial phone number	
Individual Line Access	TUV 8	Dial CO number (1 through 6)	Dial phone number
SPEED DIALING (A rotary phone will not function.)	*	Dial speed access code (00 through 99)	
CALLING DOORPHONE	For doorphone 1 DEF 3	1	For doorphone 2 DEF 3 ABC 2

Detach this position

WHEN A LINE IS BUSY

AUTOMATIC CALL BACK BUSY (camp-on) For outside calls	TUV 8	Dial CO number	Hear a busy tone	MNO 6	Hear 2 beeps	Hang up handset
For intercom calls	Dial Extension number	Hear a busy tone	MNO 6	hear 2 beeps	Hang up handset	
BUSY STATION SIGNALING	Dial Extension number	Hear a busy tone	1			
LAST NUMBER REDIAL	Lift handset	#				

•You may dial "80" instead of pressing the "#" button.

To Make Calls

Inter Office Calling (Intercom)

Station to station dialing within the KX-T61610 system.

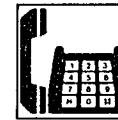

LIFT THE HANDSET

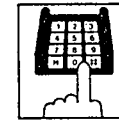

DIAL EXTENSION NUMBER (11 through 26)

Outward Dialing

Each extension can automatically select an idle CO (Central Office) line within the KX-T61610.

Automatic Line Access



LIFT THE HANDSET

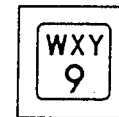

DIAL "9"

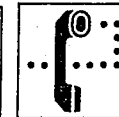

WAIT FOR C.O. DIAL TONE

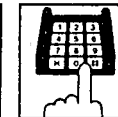

DIAL TELEPHONE NUMBER

An alternative method is to dial 8 and the CO number. The system will access individually any of the 6 CO's.

Individual Line Access

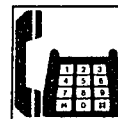

LIFT THE HANDSET

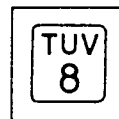

DIAL "8"

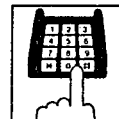

DIAL CO NUMBER (1 through 6)





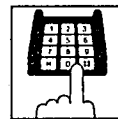



WAIT FOR C.O. DIAL TONE



DIAL TELEPHONE NUMBER

TO RECEIVE CALLS

ANSWER	Lift handset
DIAL CALL PICKUP	Lift handset  
DIRECTED CALL PICKUP	Lift handset  Dial ringing extension number
CALL PARK RETRIEVE	Lift handset  Dial parked extension number
	or Lift handset   Dial parked CO number

WHILE HAVING A CONVERSATION

CALL ON HOLD	To hold	Flash hookswitch	Hear 2 beeps
	To cancel	Flash hookswitch	
CALL SPLITTING	Flash hookswitch	Dial 2nd party	•To alternate, flash the hookswitch repeatedly
CONFERENCE	Flash hookswitch	Dial 2nd party	Consult with 2nd party
CALL WAITING	Hear a call waiting tone	Flash hookswitch	Hang up handset
	<ul style="list-style-type: none"> •Original call will be placed on hold and the new caller can be spoken with. •To terminate the original call and talk to the 2nd party, hang up and then lift the handset. (You need not flash the hookswitch.) 		Lift handset

To Make Calls (cont.)

Speed Dialing

There are 100 memory locations of system speed dialing available.



LIFT THE
HANDSET

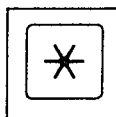

PRESS "*"

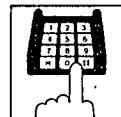

DIAL SPEED
ACCESS CODE
(00 through 99)

- There is no need to access a CO line.
- A rotary phone will not function for speed dialing.
- Continuous use of speed dialing is impossible.

Calling Doorphone

Up to two doorphone (KX-T30865) can be connected to the KX-T61610.

■ Doorphone 1



LIFT THE
HANDSET

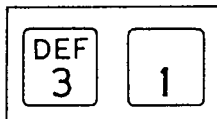

DIAL "31"

■ Doorphone 2

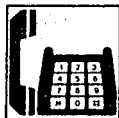

LIFT THE
HANDSET

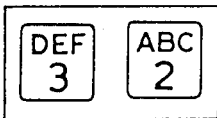

DIAL "32"

When a Line is Busy

Automatic Call Back Busy (Camp-on)

If the intercom extension or outside line you have dialed is busy, you will be automatically called back when the extension or the outside line becomes free using this function.

This feature is also known as camp-on.

■ For outside calls

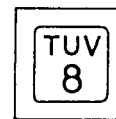

DIAL "8"

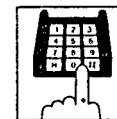

DIAL CO
NUMBER
(1 through 6)

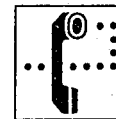

YOU WILL
HEAR A BUSY
TONE



DIAL "6"

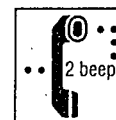

CONFIRMATION
TONE



HANG UP

■ For intercom calls

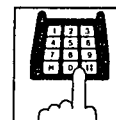

DIAL
EXTENSION
NUMBER
(11 through 26)

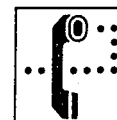

YOU WILL
HEAR A BUSY
TONE



DIAL "6"



CONFIRMATION
TONE OF
2 BEEPS WILL
BE HEARD



HANG UP

■ When hearing a ring back



LIFT THE HANDSET

- When intercom calls, you will hear the ring back tone.
- When outside calls, you will hear the dial tone from CO.
- Call back busy cannot be activated on an extension which has a call on hold.
- If you make or receive a call during the camp-on mode, the camp-on mode will be cancelled.

When a Line is Busy (cont.)

Busy Station Signaling

If the extension you have dialed is busy, you can inform that extension that another intercom call is waiting by three beeps. For use of this feature, the other extension is required to be set for this feature beforehand in the KX-T61610.

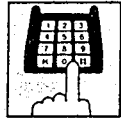

DIAL EXTENSION
NUMBER
(11 through 26)

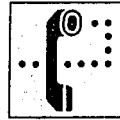

YOU WILL
HEAR A BUSY
TONE

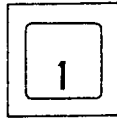

DIAL "1"

- To answer, see "Call Waiting" on page 13.

Last Number Redial

The last phone number dialed on an outgoing call (CO line) can be redialed.



LIFT THE
HANDSET

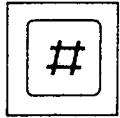

PRESS "#"

- You may dial "80" instead of pressing the "#" button.

To Receive Calls

Answer



LIFT THE
HANDSET

Dial Call Pickup

Through the use of this feature, an extension user can answer any ringing extension within their own pickup group.



LIFT THE
HANDSET

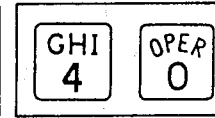

DIAL "40"

Directed Call Pickup

An extension may answer an incoming call that is ringing at another extension regardless of the pickup group.

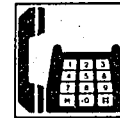

LIFT THE
HANDSET



DIAL "4"

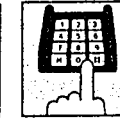

DIAL THE
RINGING
EXTENSION
NUMBER
(11 through 26)

Call Park Retrieve

Allows extension user to retrieve a call (intercom or outside) on hold at any extension.

■ To Park a call

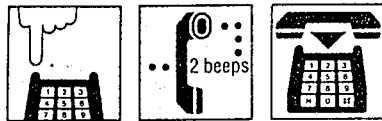

FLASH THE HOOKSWITCH CONFIRMATION TONE REPLACE HANDSET

- Do not depress the hookswitch for more than one second, or the party will be disconnected.

■ To Retrieve a Parked Call at Any Other Extension

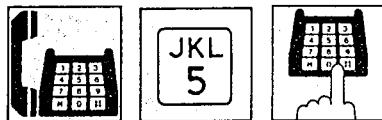

LIFT THE HANDSET DIAL "5" DIAL PARKED EXTENSION NUMBER

- Even when several outside calls are placed on hold simultaneously, you can retrieve the desired outside call from another extension as following.

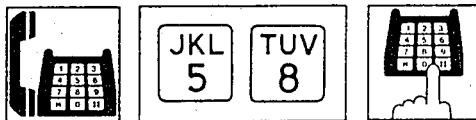

LIFT THE HANDSET DIAL "58" DIAL PARKED CO NUMBER (1 through 6)



LIFT THE HANDSET

- If calls from doorphones are not answered within 15 seconds, the call will be cancelled.
- Each extension has to be programmed for receiving from doorphones. See "Programmable Doorphone" on page 3-32 in the Installation Manual.

Call on Hold

If you wish to leave your phone unattended but want the caller you are in conversation with to wait, call on hold may be used. Intercom and outside calls may be placed on hold.

■ To Place a Call on Hold

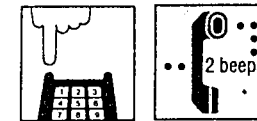

FLASH THE HOOKSWITCH CONFIRMATION TONE OF 2 BEEPS WILL BE HEARD

- Do not depress the hookswitch for more than one second, or the party will be disconnected.

■ To Cancel

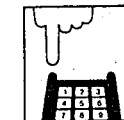

FLASH THE HOOKSWITCH

Call Splitting

Allows the station user to alternate between two parties, either intercom or outside.

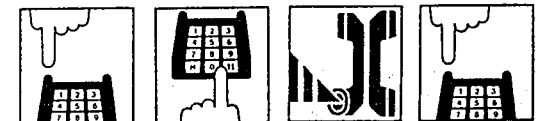

FLASH THE HOOKSWITCH DIAL THE SECOND PARTY CONSULT 2ND PARTY 1ST PARTY ON HOLD FLASH THE HOOKSWITCH

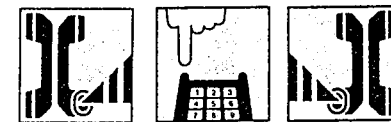

2ND PARTY ON HOLD 1ST PARTY IN CONSULTATION FLASH THE HOOKSWITCH 1ST PARTY ON HOLD 2ND PARTY IN CONSULTATION

Basic Operation

Basic Operation

Doorphone

While having a conversation (cont.)

Conference

Allows for up to a three party conference, (2-outside/ 1-inside), (1-outside/ 2-inside) or (3-inside).

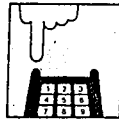

FLASH THE HOOKSWITCH PLACES 1ST PARTY ON HOLD

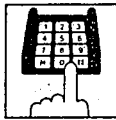

DIAL THE 2ND PARTY



CONSULT WITH THE 2ND PARTY

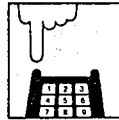

FLASH THE HOOKSWITCH

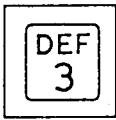

DIAL "3" (3-party conference) now established.

To Hold one Caller and Talk to the Other Caller

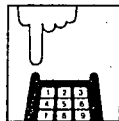

FLASH THE HOOKSWITCH



2ND PARTY ON HOLD 1ST PARTY IN CONSULTATION

Call Waiting

Call Waiting Tone during a conversation indicates there is a new incoming outside call or intercom call.

This feature is required to be set beforehand in the KX-T61610. For programming, see page 3-28 in installation manual.

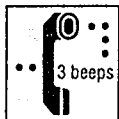

WILL HEAR CALL WAITING TONE

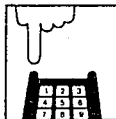

FLASH THE HOOKSWITCH PLACES 1ST PARTY ON HOLD



HANG UP

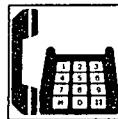

LIFT THE HANDSET



CONSULT NEW CALLER 1ST PARTY ON HOLD

- If you use the hold button of a standard telephone, the above-mentioned feature will not function.
- To terminate the original call and return to the 2nd call, hang up and then lift the handset. (You need not flash the hookswitch.)

-13-

Call Transfer

Outside or intercom calls may be transferred to any extension manually.

To Transfer After the Other Extension Answers

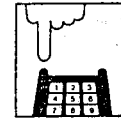

FLASH THE HOOKSWITCH

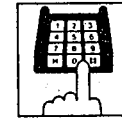

DIAL THE EXTENSION NUMBER



ANNOUNCE AND WAIT FOR AN ANSWER

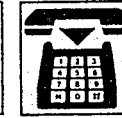

HANG UP

To Transfer without Announcing to the other Extension

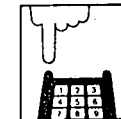

FLASH THE HOOKSWITCH

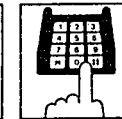

DIAL THE EXTENSION NUMBER

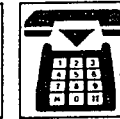

HANG UP

To Retrieve the Call

If the other extension did not receive the transferred call within 30 seconds after the call has been transferred, the call will return to you. In this case:



LIFT THE HANDSET

To Change the Party to Whom a Call is Transferred before Hanging up

Flash the hookswitch to retrieve the call, then repeat the procedure of Call Transfer.

-14-

Use of Other Features

Paging All Extensions

Allows paging to all extensions.

To Access



LIFT THE HANDSET

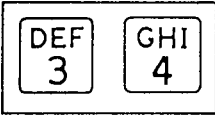

DIAL "34"

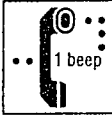

CONFIRMATION TONE OF 1 BEEP WILL BE HEARD



PAGE



WAIT FOR AN ANSWER AND TALK

- Page will be heard only from the built-in speaker of KX-T61630, KX-T61620, KX-T61650, KX-T30830, KX-T30820 or KX-T30850. It will not be heard from the built-in speaker of standard telephone.

Paging Group

Allows paging to one of four groups.

To Access

For Pickup Group 1



LIFT THE HANDSET

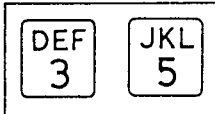

DIAL "35"

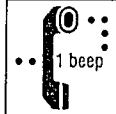

CONFIRMATION TONE



PAGE



WAIT FOR AN ANSWER AND TALK

- For Pickup Group 2: At step 2 above, dial 36 instead of 35.
- For Pickup Group 3: At step 2 above, dial 37 instead of 35.
- For Pickup Group 4: At step 2 above, dial 38 instead of 35.

- Page will be heard only from the built-in speaker of KX-T61630, KX-T61620, KX-T61650, KX-T30830, KX-T30820 or KX-T30850. It will not be heard from the built-in speaker of standard telephone.

Paging-External

Allows access to external paging equipment.

To Access



LIFT THE HANDSET

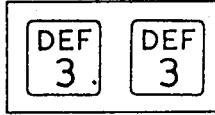

DIAL "33"

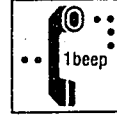

CONFIRMATION TONE



PAGE



WAIT FOR CONFIRMATION TONE AND TALK OR HANG UP



Page will be heard from external paging equipment.

Paging and Transfer

To Transfer a Call to the Paged Person

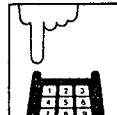

FLASH HOOKSWITCH TO PLACE A CALL ON HOLD

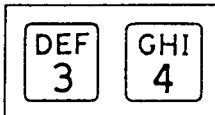

DIAL "34"

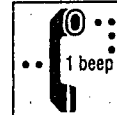

CONFIRMATION TONE



PAGE



WAIT FOR AN ANSWER AND HANG UP

- At step 2 above, you may dial 35, 36, 37, 38 or 33 instead of 34 for the correct pickup group.

Detailed Operation

Detailed Operation

Paging-Answer

A page from built-in speaker or external paging equipment can be answered from any extension.

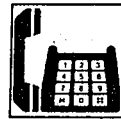

LIFT THE HANDSET

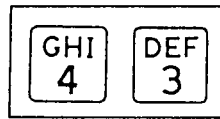

DIAL "43"

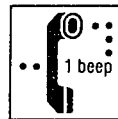

CONFIRMATION TONE OF 1 BEEP WILL BE HEARD



TALK

Intercom Alerting Mode

"Voice alerting" (through built-in speaker) that is established at the called party's extension, can be switched to "Tone alerting" (ringing).

• This feature is required to be set beforehand in the KX-T61610. For programming, see page 3-31 in installation manual.

Switching to Tone Alerting



LIFT THE HANDSET

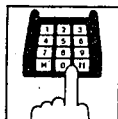

DIAL EXTENSION NUMBER (11 through 26)

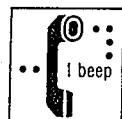

WAIT UNTIL A CONFIRMATION TONE IS HEARD

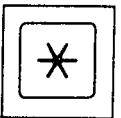

PRESS "*"



RING BACK TONE

- A rotary phone will not function with this feature.
- Press the "*" button within 10 seconds after the dialing.

External Feature Access

Allows the extension user to access features of the central office or host PBX. (e.g. CALL WAITING FEATURE can be supplied by the Central Office.)

• The external feature (call waiting) can only be accessed when engaged on an outside call.

• The following example shows you one of the procedures.

Call Waiting—Outside Line

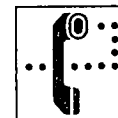

WILL HEAR A CALL WAITING TONE

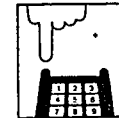

FLASH THE HOOKSWITCH

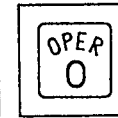

DIAL "0"



CONSULT WITH THE NEW CALLER WHILE THE ORIGINAL CALL IS ON HOLD

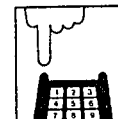

FLASH THE HOOKSWITCH

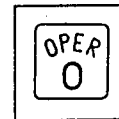

DIAL "0"



CONSULT WITH THE ORIGINAL CALLER WHILE THE 2ND CALL IS ON HOLD

(If the calling party on hold hangs up, the line is terminated.)

- Flashing the hookswitch and dialing "0" means flash operation.
- If the KX-T61610 is connected to a host PBX and a flash operation is required, follow the procedure of flash operation which is required for the host PBX.

Pulse/Tone Conversion

If the dialing mode is required to change from the pulse mode to the tone mode in one dialing sequence, this feature is used. (e.g. computer-accessed long distance service)

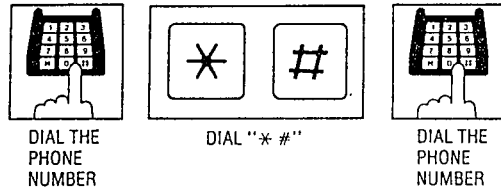

- When you dial using this feature, you must use the line selected in the pulse mode.
- Phone number after dialing "* #" will be changed to the tone mode.
- A rotary phone will not function with this feature.
- Press the "*" and "#" buttons within 5 seconds after the number of the long distance service company.

- If you use a standard telephone equipped with automatic dialer, be careful of the following:
Example: Computer-accessed long distance service

- Local access telephone number of the alternate long distance service company 765-4321, Authorization no. 0123456, Long distance no. 543-210-9876
- Pulse mode is required by local access telephone number of the alternate long distance service company.
- Service of MCI, SPRINT, METRO or other systems is used.

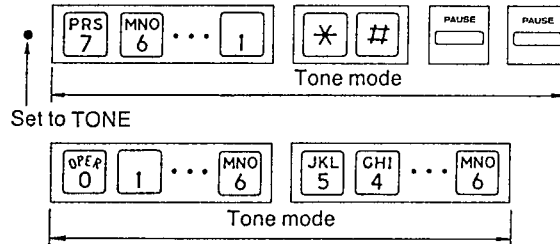

Account Code

This feature gives each message of the SMDR an account code of the called or calling party. (Station Message Detail Recording—SMDR is cost saving feature that records all incoming and outgoing calls through the CO line.)

This feature has two modes "Forced" and "Option". In the "Forced" mode, the account code must be entered every time the extension user dials. In the "Option" mode, account code may be entered when a record of the account code is needed. When setting to the "Forced" mode, see page 3-34 in INSTALLATION MANUAL.

Forced Mode

■ Making a Call

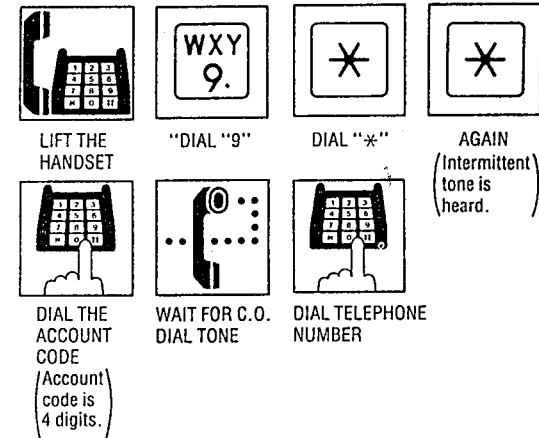

- Account code must be required 4 numerical digits except for the # and * buttons.
- You may dial 81 through 86 instead of dialing 9.

■ Receiving a Call

If you want to record a calling party's account code in the SMDR, follow the below-mentioned procedure. Within 30 seconds after calling party hangs up,

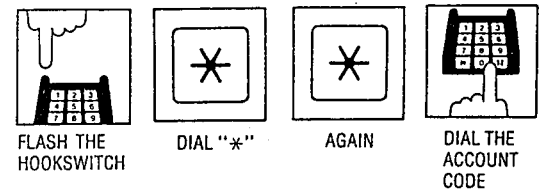

- Dialing the account code must be done before hanging up.

Option Mode

■ Making or Receiving a Call

If you want to record a calling or called party's account code in the SMDR, follow the below-mentioned procedure.

Within 30 seconds after calling or called party hangs up,

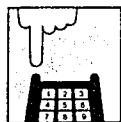

FLASH THE HOOKSWITCH

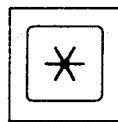

DIAL "*"

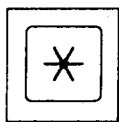

AGAIN

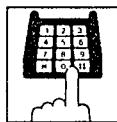

DIAL THE ACCOUNT CODE
(Account code is 4 digits.)

- Dialing the account code must be done before hanging up.

- You may dial 49 instead of pressing the * * button.
- Account code must be 4 digits.
- If you enter a wrong account code, press the * * button and enter the correct code.

You may dial "0" instead of pressing the "#" button.

Call Forwarding

Intercom or outside calls to your extension can be automatically forwarded to any extension within the system.

■ Setting

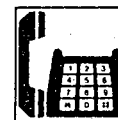

LIFT THE HANDSET

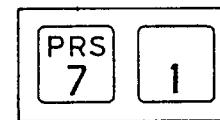

DIAL "71"

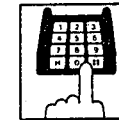

DIAL THE EXTENSION NUMBER

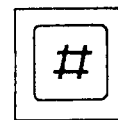

DIAL "#"



HANG UP

■ To Cancel



LIFT THE HANDSET

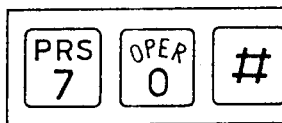

DIAL "70#"

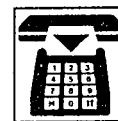

HANG UP

Station Programming (cont.)

Dial Call Pickup Deny

Allows you to prohibit any other extension user from answering calls directed to you.

■ Setting

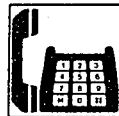

LIFT THE
HANDSET

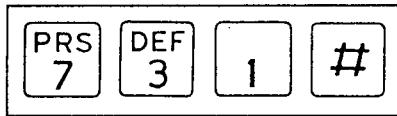

DIAL "731#"



HANG UP

■ To Cancel



LIFT THE
HANDSET

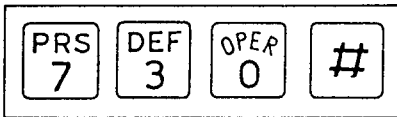

DIAL "730#"



HANG UP

Do not Disturb

Each extension can be individually programmed from receiving outside or intercom calls.

■ Setting

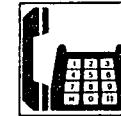

LIFT THE
HANDSET

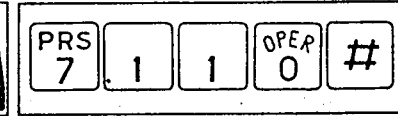

DIAL "7110#"



HANG UP

■ To Cancel

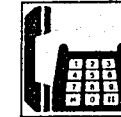

LIFT THE
HANDSET

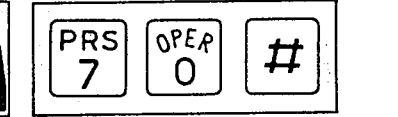

DIAL "70#"



HANG UP

Detailed Operation

Detailed Operation

Station Programming (cont.)

Data Line Security

This feature provides security when transmitting data through an extension of the KX-T61610. Call waiting tones or hold time reminder tone from the KX-T61610 are prohibited in this mode.

■ Setting

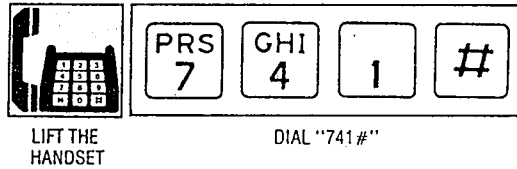

■ To Cancel

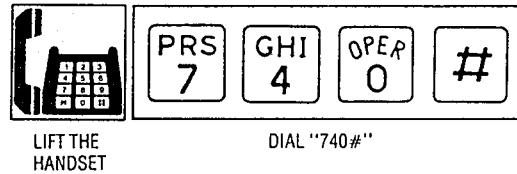

Pickup Dial

Picking up the handset automatically dials a programmed phone number.

■ To Program

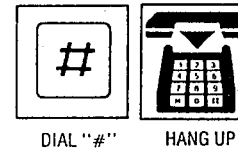
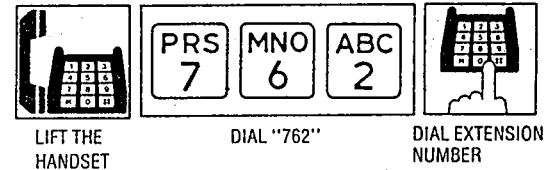

- You may dial CO number (9 or 81 through 86) instead of extension number.

■ To Enable or Disable

To enable pickup dial

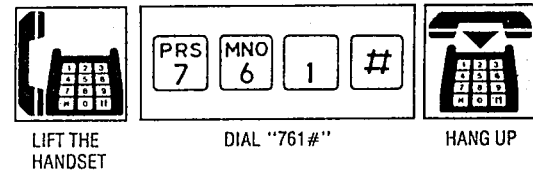

To disable pickup dial

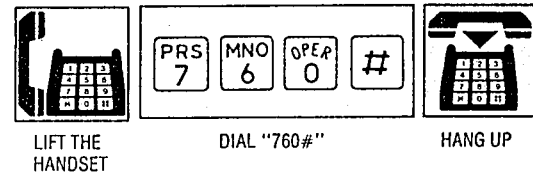

■ To Dial



PICKUP HANDSET
FOR 4-SECONDS

If the "Pickup Dial" feature did not work, hang up for over 1 second, and lift the handset again.

- Dialing (speed dialing and manual dialing) is possible within 3 seconds.
- When you program for an outside call, enter the line access number, [*] [*], account code, and then the desired number.
- The pickup dial will not be activated by picking up the handset during a hold or when receiving a call.
- A rotary phone is not available for Pickup Dial.
- You can not dial "0" instead of pressing the "#" button.

Station Program Clear

Dialing (79#) will clear station programs on that extension.

- The following feature can be canceled.
Call Forwarding
Data Line Security
Dial Call Pickup Deny
Do not Disturb
Pickup Dial (Enable mode)



LIFT THE
HANDSET

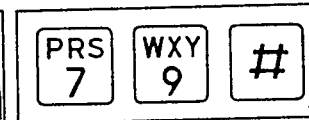

DIAL "79#"



HANG UP

- If the dial tone (continuous tone) changes to a reorder tone (intermittent tone) or a mistake is made, hang up and start again.
- Various activation tones and Ringing will be heard. (Refer to page 6-6 in INSTALLATION MANUAL.)
- If your phone has a FLASH button, depress it instead of flashing the hookswitch.

Contents

Absent messages capability.....	1232 only	11
Auto Answering Selection (CO).....		9
Auto Answer Intercom call.....		7
Auto call-back busy (Camp On).....		2
Auto Central Office (CO) line hunting.....		7
Automatic redial.....		11
Background music.....		5
Busy station signalling.....		6
Call forwarding.....		13
Call Door box / Door Opener.....		7
Call pickup (from another ringing phone).....		2
Call splitting.....		8
Call waiting programming.....	1232 only	13
Camping onto a busy extension line.....		2
Camping onto a busy CO line.....		2
Conferencing.....		10
Data Line Security.....		15
Do Not Disturb.....		7
DSS console operation.....	616/1232	12
Flash Key.....		5
Flexible CO and Message buttons		
Resetting CO buttons.....		6
Change CO button to DSS/BLF.....		6
Change CO button to One Touch Dial.....		6
Resetting Message Button.....		6
Function button programming.....		10
Hold / Exclusive hold.....		5
Intercom answer mode.....		7
Intercom alerting (station setting).....	1232 only	14
Last number redial.....		11
Locking your station (Electronically).....		9
Making calls.....		2
Message button programming.....	1232 only	6
Message waiting setting.....	1232 only	11
Mode Check.....		15
One touch dial buttons.....		4
Paging.....		3
Paging All Extension and External.....	1232 only	4
Paged call pickup.....		4
Saved number redial.....		10
Station program clear.....		14
Speed dialling.....		2
Time / Day Display toggle.....		15
Transferring calls.....		4







Panasonic

KX-T7000 User Guide



For KX-T308/616/1232

This system installed by





Making Calls

FEATURE	KEY SEQUENCE
Intercom Calling - Extension to extension calling within the system.	LIFT HANDSET OR PRESS 'SP-PHONE'  or  DIAL EXTENSION NUMBER PRESS DSS/BLF BUTTON
Outside Line Calling - Extension to outside (CO) line. Dial 9 for any available CO line. Dial 81 for trunk group 1. Dial 82 for trunk group 2 etc	LIFT HANDSET OR PRESS 'SP-PHONE'  or  or   & CO TRUNK GROUP DIAL REQUIRED NUMBER



Automatic Call-back Busy (Camp-on)

Camp On - If all CO lines or the extension you are calling is busy the system will call you back when a CO line is free or the extension is no longer busy.	HEAR BUSY TONE  HEAR CONFIRMATION TONE 
---	---



















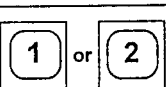





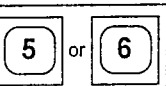





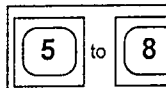

Call Pickup

Call Pickup allows you to answer any on-hook, ringing extension in your extension group.	LIFT HANDSET OR PRESS 'SP-PHONE'  
Directed Call Pickup allows you to answer any on-hook, ringing extension on the system.	LIFT HANDSET OR PRESS 'SP-PHONE'   DIAL EXTENSION THAT IS RINGING

Speed Dialling

System Speed Dial allows you to access the pool of numbers that are stored on your system. NOTE: Telephone numbers can only be stored at system programming completion.	LIFT HANDSET OR PRESS 'SP-PHONE'   SPEED DIAL ACCESS NUMBER (308 - 00 to 79) (616/1232 - 00 to 99)
--	---

Paging

FEATURE	KEY SEQUENCE
Paging - External Your facility must be equipped with an external paging system(s).	308/616 LIFT HANDSET OR PRESS 'SP-PHONE'    SPEAK
	1232 LIFT HANDSET OR PRESS 'SP-PHONE'     PAGES BOTH ZONES SPEAK
	OR    or   PAGES ZONE #1 or #2 SPEAK
Paging All Extensions or Group Your system must be programmed for different paging zones for this feature. See Installation manual for default setting and programming instructions.	308 LIFT HANDSET OR PRESS 'SP-PHONE'    PAGES ALL PROPRIETARY TELEPHONES
	OR   or   PAGES GROUP #1 or #2
	616 LIFT HANDSET OR PRESS 'SP-PHONE'    PAGES ALL PROPRIETARY TELEPHONES
	OR   to   PAGES GROUP #1 to #4
	1232 LIFT HANDSET OR PRESS 'SP-PHONE'     PAGES ALL PROPRIETARY TELEPHONES
	OR    to   PAGES GROUP #1 to #8

Paging All Extensions and External

FEATURE	KEY SEQUENCE
Paging ALL - Pages all proprietary telephones and PA systems.	<p>1232</p> <p>LIFT HANDSET OR PRESS 'SP-PHONE'</p> <p>SPEAK</p>

Paged Call Pickup

Paged Call Pickup - Allows you to answer an ongoing page and speak to person making the page.	<p>308/616</p> <p>LIFT HANDSET OR PRESS 'SP-PHONE'</p> <p>FROM BUILT IN SPEAKER</p> <hr/> <p>1232</p> <p>LIFT HANDSET OR PRESS 'SP-PHONE'</p> <p>FROM BUILT IN SPEAKER FROM EXTERNAL PAGER 1 OR 2</p>
---	---

Transferring Calls

Transferring a call to Another Extension - The transfer mode must be selected at the system programming extension.	<p> AND/OR </p> <p>DIAL THE STATION NUMBER ANNOUNCE CALL TO 2nd PARTY OR HANG UP TO TRANSFER</p>
NOTE: DO NOT PRESS THE HOLD BUTTON	<p>This feature can be used in conjunction with page and paged call pick up. If paging feature is selected instead of station number a person can be paged and then using the paged call pickup feature the paged person can turn that page into a normal call.</p>

One-touch Dial Buttons

Pre-programmed CO, Function or MESSAGE buttons can be used to make calls or set system features using one key press.	<p>LIFT HANDSET OR PRESS 'SP-PHONE' 'MONITOR'</p> or or
--	--

Background Music

FEATURE	KEY SEQUENCE
Background Music - If your system has a music on hold source then individual proprietary stations can be set to play the music from the built in speaker of the telephones. Background music will play until your phone rings or you initiate a call.	<p>308/616</p> <p>LIFT HANDSET OR PRESS 'SP-PHONE' 'MONITOR'</p> <p>TO SET or CANCEL</p> <hr/> <p>1232</p> <p>MUSIC ON/OFF</p> <p>NO NEED TO LIFT HANDSET</p>

FLASH Key

FLASH Key - To get dial tone on an outside line after the party on the other end has hung up or to use other external features such as conferencing provided by the local telephone company.	
--	--

Hold / Exclusive Hold

Hold allows you to place a CO line or Intercom call on hold. The CO you have placed on hold will flash Green at your station and flash Red at all others.	
Retrieving Calls on Hold allows you to pickup calls that have been placed on normal hold at your or another extension.	<p> OR OR </p> <p>FOR CO CALLS (FLASHING) AT HOLDING EXTENSION DIAL NO OF HOLDING EXTENSION FOR INTERCOM CALLS</p>
Exclusive Hold allows you to place a CO or Intercom calls on hold that can only be retrieved from your extension. The CO you have placed on hold will flash Green at your extension and remain Red at all others.	<p> </p> <p>PRESS TWICE WHILE TALKING TO CO LINE.</p>

Flexible CO & Message Buttons

FEATURE	KEY SEQUENCE
<p>Resetting CO button OR re-assigning CO numbers.</p> <p>NOTE: SET / PROGRAM switch can be found at rear of station.</p>	<p>SET SWITCH CO 0 1 2 3 4 5 6 7 8 9 AUTO DIAL STORE SET SWITCH</p> <p>DIAL NEW CO NUMBER (01-12 for KX-T123211)</p>
<p>Changing CO & MESSAGE button to DSS/BLF (Direct Station Select / Busy Lamp Field) - Allows you to call another station using one key and indicates if that station is busy.</p>	<p>SET SWITCH CO OR MESSAGE BUTTON 1 1 2 3 4 5 6 7 8 9 AUTO DIAL STORE SET SWITCH</p> <p>DIAL STATION NUMBER</p>
<p>Changing CO & MESSAGE button to One-touch Dialling - To store a phone number or programmable function to a CO or MESSAGE button on your phone.</p> <p>NOTE: Entering a 9 before your telephone number will tell system to auto-select any available CO line. Dial 81,82 etc to select CO line 1 or 2 etc</p>	<p>SET SWITCH CO OR MESSAGE BUTTON 2 1 2 3 4 5 6 7 8 9 AUTO DIAL STORE SET SWITCH</p> <p>DIAL NUMBER</p>
<p>Re-setting MESSAGE button - changes a previously programmed MESSAGE button back to message feature.</p>	<p>SET SWITCH MESSAGE 3 AUTO DIAL STORE SET SWITCH</p>

Busy Station Signalling

<p>Busy station signalling - If a called station is busy then a call waiting tone can be initiated indicating to the busy station that another station is trying to call.</p> <p>NOTE: Your system must be programmed to allow you to use this feature.</p>	<p>HEAR BUSY TONE 1 TALK TO CALLED PARTY OR HANG UP IF NO ANSWER</p>
---	--

Do Not Disturb

FEATURE	KEY SEQUENCE
<p>Do Not Disturb feature will stop your station ringing on incoming calls. Intercom dial tone will beep twice when you pick up to remind you that this feature is set.</p> <p>NOTE: If your station does not have a FWD/DND button then F3 can be programmed to perform this function. See Installation manuals.</p>	<p>308/616</p> <p>LIFT HANDSET OR PRESS 'SP-PHONE' 'MONITOR'</p> <p>FWD / DND 1 0 or 0 </p> <p>TO SET or CANCEL</p> <hr/> <p>1232</p> <p>LIFT HANDSET OR PRESS 'SP-PHONE' 'MONITOR'</p> <p>FWD / DND 4 or 0 # </p> <p>TO SET or CANCEL</p>

Auto CO Hunting

<p>Auto-CO Hunting Your proprietary station can be set to automatically select a free CO line when you pick up the handset or press SP-PHONE.</p> <p>NOTE : After setting this feature you must press the INTERCOM button to access other system features (eg to cancel feature)</p>	<p>308/616</p> <p>LIFT HANDSET OR PRESS 'SP-PHONE' 'MONITOR'</p> <p>7 2 1 or 0 # </p> <p>TO SET or CANCEL</p> <hr/> <p>1232</p> <p>LIFT HANDSET OR PRESS 'SP-PHONE' 'MONITOR'</p> <p>SET SWITCH 1 2 or 1 AUTO DIAL STORE SET SWITCH</p> <p>TO SET or CANCEL</p>
--	---







Automatic Answer Intercom

<p>Automatic answer mode allows you to choose between answering intercom calls by lifting handset or automatically answering using the SP-PHONE facility</p> <p>NOTE: This feature is not available on KX-T7050/55</p>	<p>If LED is OFF the station will ring on receiving intercom call. If LED is ON the station will become active on receiving an intercom call.</p> <p>WARNING: The caller can now hear you !</p> <p>AUTO ANSWER MUTE</p>
--	---

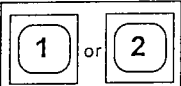

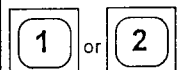



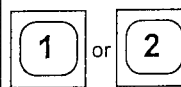

Doorbox & Door Opener

<p>Answering Doorbox #1 or #2</p>	<p>LIFT HANDSET OR PRESS 'SP-PHONE'</p>
-----------------------------------	---





















Doorbox & Door Opener (cont)

FEATURE	KEY SEQUENCE
<p>Calling Doorbox #1 or #2 - To speak to someone through a doorbox without them pressing the door phone button first.</p>	<p>308/616</p> <p>LIFT HANDSET OR PRESS 'SP-PHONE'</p> <p> </p> <p>DIAL FOR DOORBOX #1 or #2</p> <hr/> <p>1232</p> <p>LIFT HANDSET OR PRESS 'SP-PHONE'</p> <p>  </p> <p>DIAL FOR DOORBOX #1 or #2</p>
<p>Opening Door #1 or #2 while talking to the doorbox - Your system must be equipped with doorbox(s) and door opener for this feature.)</p>	<p></p> <p>WHILE TALKING TO DOORBOX.</p>
<p>Activating door opener #1 or #2 without talking to door phone.</p>	<p>LIFT HANDSET OR PRESS 'SP-PHONE' 'MONITOR'</p> <p>  </p> <p>DIAL TO OPEN DOOR #1 OR #2</p>





Call Splitting

<p>Call Splitting Intercom Calls - Allows you to switch between two different intercom conversations.</p>	<p>LIFT HANDSET OR PRESS 'SP-PHONE'</p> <p>   </p> <p>MAKE 1st PARTY CALL PLACES 1st PARTY ON HOLD MAKE 2nd PARTY CALL PRESS TO SWAP BETWEEN PARTY 1 & 2</p>
<p>Call Splitting Between CO & Intercom - allows you to switch between a CO line and intercom call.</p>	<p>    or </p> <p>PLACES 1st PARTY ON HOLD MAKE 2nd PARTY CALL PLACES 2nd PARTY ON HOLD PRESS FLASHING BUTTON TO SWAP BETWEEN CALLS REPEAT STEP 3 & 4 TO SWAP BETWEEN CALLS</p>

Locking Your Station (Electronically)

FEATURE	KEY SEQUENCE
<p>Station Locking - allows users to prevent unauthorised outgoing calls until lock code is entered. (Incoming & Intercom calls are as normal)</p> <p>WARNING : If number is forgotten, station will have to be reset from System Programming Station.</p>	<p>308/616</p> <p>LIFT HANDSET OR PRESS 'SP-PHONE'</p> <p>    </p> <p>LOCK CODE 000 TO 999 REPEAT CODE</p> <hr/> <p>1232</p> <p>LIFT HANDSET OR PRESS 'SP-PHONE'</p> <p>     </p> <p>LOCK CODE 000 TO 999 REPEAT CODE</p>
<p>Station Unlocking - cancels above feature.</p>	<p>308/616</p> <p>LIFT HANDSET OR PRESS 'SP-PHONE'</p> <p>   </p> <p>DIAL LOCK CODE 000 TO 999</p> <hr/> <p>1232</p> <p>LIFT HANDSET OR PRESS 'SP-PHONE'</p> <p>     </p> <p>DIAL LOCK CODE 000 TO 999</p>

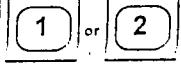
Automatic Answering Selection

<p>Auto-Pick Up of CO lines can be enabled/disabled allowing you to choose if you wish incoming CO calls to be answered on picking up handset/SP-PHONE or by first pressing the flashing CO button.</p> <p>NOTE: Your extension must be programmed to receive CO calls. SET / PROGRAM switch can be found at the rear of the station.</p>	<p>308/616</p> <p>Must be set at system programming station. See Installation manuals</p> <hr/> <p>1232</p> <p>    </p> <p>TO DISABLE OF ENABLE</p>
--	--

Conferencing

FEATURE	KEY SEQUENCE
<p>Conference allows you to set up a three party conference call. The call can be between (3 inside), (2 inside 1 outside) or (1 inside / 2 outside).</p>	<p>LIFT HANDSET OR PRESS 'SP-PHONE'</p> <p>MAKE 1st PARTY CALL PLACES 1st PARTY ON HOLD MAKE 2nd PARTY CALL AFTER 2nd PARTY ANSWERS</p>
<p>Conference splitting allows you to split a (1 inside and 2 outside) conference call. After hanging up or pressing the CO button of the 2nd party, the first call is terminated.</p>	<p>1232</p> <p>PLACES BOTH PARTIES ON HOLD PRESS CO BUTTON OF 1st PARTY HANG UP OR PRESS CO BUTTON OF 2nd PARTY</p>

Function Button Programming

<p>F-- (function) Buttons - allow you to store telephone numbers or system features for one touch operation.</p> <p>NOTE: SET / PROGRAM switch on rear of the station.</p>	<p>SET SWITCH SELECT A FUNCTION TELEPHONE NUMBER OR SYSTEM FEATURE AUTO DIAL STORE SET SWITCH</p>
--	---

Saved Number Redial

<p>Temporary Number Save - allows you to store a number and redial it at any time.</p> <p>NOTE: If your station does not have a save button, F1 can be programmed to perform this function. See Installation manuals.</p>	<p>LIFT HANDSET OR PRESS 'SP-PHONE' 'MONITOR'</p>
<p>Automatic Redial of Temporary Saved Number - redials the saved number using the F1/SAVE button.</p>	<p>- REDIAL ONLY ONCE.</p> <p>- UP TO 15 TIMES IN 10 MINUTES</p>

Automatic / Last Number Redial

FEATURE	KEY SEQUENCE
<p>Automatic Redial of last CO call - allows you to redial last number with one key press.</p>	<p>- REDIAL ONCE ONLY</p>
<p>NOTE: Lifting the handset will set the system to call once. By pressing the SP-PHONE key the system will redial number up to 15 times if the called number is busy.</p>	<p>- UP TO 15 TIMES IN 10 MINUTES</p>

Message Waiting (1232 only)

<p>Set Message Waiting allows you to send a signal to a busy or non-answering station and turns the message LED on at that station.</p>	<p>AFTER HEARING BUSY TONE OR RECEIVING NO ANSWER.</p>
<p>Cancel Message Waiting allows you to cancel a message you have left at another station.</p>	<p>LIFT HANDSET OR PRESS 'SP-PHONE' 'MONITOR'</p> <p>DIAL STATION WHERE YOU LEFT MESSAGE PRESS TWICE</p>
<p>Cancel a Left Message allows you to cancel a message left on your station. The message LED will go out on your station.</p>	<p>LIFT HANDSET OR PRESS 'SP-PHONE' 'MONITOR'</p>
<p>Answer Message - allows you to return the call of a station that has set your message LED.</p>	<p>LIFT HANDSET OR PRESS 'SP-PHONE'</p>

Absent Message Capability (1232 only)

<p>Absent message programming - allows messages to be displayed at any station that calls you. (Provided calling station has an LCD display)</p>	<p>LIFT HANDSET OR PRESS 'SP-PHONE' 'MONITOR'</p> <p>TO CANCEL FEATURE</p>
---	--

Absent Message Capability (cont)

FEATURE	KEY SEQUENCE
MESSAGE 1: Will Return Soon	LIFT HANDSET OR PRESS 'SP-PHONE' 'MONITOR'
MESSAGE 2: Gone Home	LIFT HANDSET OR PRESS 'SP-PHONE' 'MONITOR'
MESSAGE 3: At Ext _____ (you fill in)	LIFT HANDSET OR PRESS 'SP-PHONE' 'MONITOR' STATION NUMBER
MESSAGE 4: Back at HH:MM:AM/PM (you fill in)	LIFT HANDSET OR PRESS 'SP-PHONE' 'MONITOR' HOUR (01-12) MIN (00-59) AM=0, PM=1
MESSAGE 5: Out until MM/DD (you fill in)	LIFT HANDSET OR PRESS 'SP-PHONE' 'MONITOR' MONTH (01-12) DATE (01-31)
MESSAGE 6: In a meeting	LIFT HANDSET OR PRESS 'SP-PHONE' 'MONITOR'

DSS Console

The Direct Station Select (DSS) console acts as an extension to the DSS/BLF & Function keys of the paired station. Activating and programming the console is performed using the handset / set / program / store features of the paired station. Follow the programming instructions for a normal station to program different extension numbers or system features into the console. A station must be set up as the paired station prior to using the console.

616/1232
Making calls
 LIFT HANDSET OR PRESS 'SP-PHONE' (paired station)
 OR
DSS/BLF BUTTON FUNCTION BUTTON

Transferring calls
 WHILE TALKING TO PARTY
 AND/OR
DSS/BLF BUTTON ANNOUNCE CALL and/or HANG UP

NOTE : When system is set to 'WITH TRANSFER' mode (default) pressing the TRANSFER button can be omitted.

Call Forwarding

FEATURE	KEY SEQUENCE
Call Forwarding All Calls forwards all calls to another station without first ringing your station NOTE: If your station does not have a FWD/DND button then F3 can be programmed to perform this function. See Installation manuals.	308/616 LIFT HANDSET OR PRESS 'SP-PHONE' 'MONITOR' <small>DIAL NEW STATION NUMBER</small>
Call Forwarding When Busy/No Answer - forwards all calls to another station. System tries to ring your station first.	1232 LIFT HANDSET OR PRESS 'SP-PHONE' 'MONITOR' <small>DIAL NEW STATION NUMBER</small>
Cancelling Call Forwarding	308/616 LIFT HANDSET OR PRESS 'SP-PHONE' 'MONITOR' 1232 LIFT HANDSET OR PRESS 'SP-PHONE' 'MONITOR'

Call Waiting Programming (1232 only)

Programmable call waiting feature allows you to specify if a call waiting tone is given when an intercom or CO call arrives at your busy extension.

NOTE: This feature must be set at system programming station for 308/616 systems. See installation manuals.

LIFT HANDSET OR PRESS 'SP-PHONE' 'MONITOR'

DISABLES (default) CO CALL WAITING TONE

ENABLES CO LINE WAITING TONE

Call Waiting Programming (1232 cont)

FEATURE

KEY SEQUENCE

Programmable call waiting feature allows you to specify if a call waiting tone is given when an intercom or CO call arrives at your busy extension.

LIFT HANDSET OR PRESS 'SP-PHONE' 'MONITOR'



Station Program Clear

Allows you to reset the following programmable features.

- 1) Absent message capability
- 2) Auto CO hunting
- 3) Automatic answer selection
- 4) Background music
- 5) Call forwarding
- 6) Call waiting tone selection
- 7) CO line ringing selection
- 8) Data line security
- 9) Dial call pickup deny
- 10) Do not disturb
- 11) F3 Button mode
- 12) Intercom alerting mode
- 13) Message waiting

308/616

LIFT HANDSET OR PRESS 'SP-PHONE' 'MONITOR'

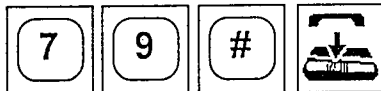

1232

LIFT HANDSET OR PRESS 'SP-PHONE' 'MONITOR'

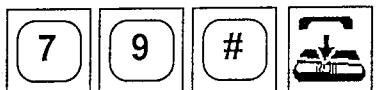

SET SWITCH

SET SWITCH

Clears features :2,3,6,7,11 and 12

Intercom Alerting Mode (1232)

Intercom Alerting Mode allows you to set your station to receive voice alerts rather than tone (ringing) alert. Caller must then announce call rather than the station ringing.

NOTE:This feature must be set at the system programming station for the 308/616 systems.

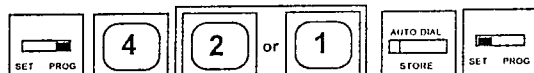

SET SWITCH

TO SET VOICE OR TONE (default)

SET SWITCH

Data Line Security

FEATURE

KEY SEQUENCE

Data Line Security prohibits signals being sent to your station that may corrupt data which may be currently being sent through your extension.

308/616

LIFT HANDSET OR PRESS 'SP-PHONE' 'MONITOR'



1232

LIFT HANDSET OR PRESS 'SP-PHONE' 'MONITOR'



Mode Check

Mode Check indicates at proprietary stations (with LCD) if your system is in DAY or NIGHT mode



NB: DO NOT LIFT HANDSET OR PRESS SP-PHONE

Time / Day Toggle

Time / Day toggle changes proprietary stations (with LCD) from DAY / TIME to DAY / DATE setting.



NB: DO NOT LIFT HANDSET OR PRESS SP-PHONE

User Guide

Panasonic KX-T7130 Phone When Used With KX-T30810 and
KX-T61610 Phone Systems



Index

Feature	Page#
Auto CO (Central Office) Line Hunting.....	5
Background Music.....	3
Busy Station Signalling.....	4
Call Pickup (Answer another ringing phone).....	7
Call-Splitting Intercom Calls.....	8
Call Waiting (inside system).....	4
Call Waiting (from Telephone Company[Flash])...3	
Calling Doorbox.....	6
Calling Inside Office (Intercom).....	1
Calling Out.....	1
Central Office (CO) Button Programming:	
CO Button to Direct Intercom/Busy Lamp.....	10
CO Button to Memory Dial Button.....	10
Conferencing.....	8
Dialed Call Pickup.....	7
Directed Call Pickup.....	7
Do Not Disturb.....	11
Doorbox & Door Opener.....	6
Exclusive Hold.....	5
Flash Key.....	3
Hold.....	5
Intercom Calls.....	1
Locking your Extension.....	6
Outside Calls.....	1
Page Call Pickup.....	2
Paging.....	2
Program Clearing (Resets Phone Features).....	11
Speed Dial.....	9
Station Locking.....	6
Transfer Calls to Other Phones.....	3

Making Calls











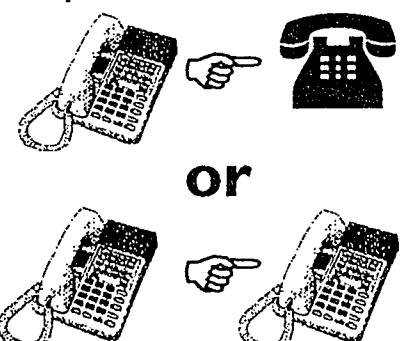

Press the **SP-PHONE** button or lift the handset. You will hear *Intercom Dial Tone*.

Feature Description	Operation Procedures
Intercom Calling Station to station calling within the system.	<ol style="list-style-type: none"> While listening to <i>Intercom Dial Tone</i> (see above) Dial the extension number or press the DSS/BLF key for the party you want. (See Programming DSS/BLF Keys on Page 10). If you have initiated this call with the Speakerphone, you may now continue it hands free or pickup the handset.
Outside Line Calling Station to outside CO (Telephone Company Central Office line) calling.	<ol style="list-style-type: none"> While listening to <i>Intercom Dial Tone</i> (see above) Dial WXY9 to select any available outside line that you are allowed to use. (You can also Dial "81" for line #1; "82 for line #2, etc.) Press OR CO (line--) <p>(Use of CO Buttons does not require pressing SP-PHONE button first. Just pressing the CO Button will automatically turn on the Speaker Phone feature.)</p> <ol style="list-style-type: none"> Dial the Phone Number you want. If you have initiated this call with the Speakerphone, you may now continue it hands free or pickup the handset.
Camping onto CO Line	<ol style="list-style-type: none"> If all available lines are in use, dial WXY9 and after you hear the busy signal, dial MNO6 Hang up and the system will call you back when a line is available.

Paging

Feature Description	Operation Procedures
Paging (Through Public Address System)	<ol style="list-style-type: none"> Lift Handset OR Press SP-PHONE Dial DEF 3 DEF 3 Make Announcement.
Paging (Through telephone speakers) and Paging to Zones (Your phone system must be programmed for different Paging Zones for this feature to work.)	<ol style="list-style-type: none"> Lift Handset OR Press SP-PHONE Dial DEF 3 GHI 4 <p>to page all phones or Dial "35" to page phones in Paging Zone #1; Dial "36" to page phones in Pickup Group #2; Dial "37" to page phones in Pickup Group #3; Dial "38" to page phones in Pickup Group #4</p> <ol style="list-style-type: none"> Make Announcement.
Page Call Pickup Allows any phone to answer an ongoing page and turns the page into an intercom call.	<ol style="list-style-type: none"> Lift Handset while page is in progress Dial GHI 4 DEF 3 Talk to person who made page.
Paging with Transfer to send an outside line call to any extension which answers a page.	<ol style="list-style-type: none"> While talking on an outside line or intercom call press TRANSFER Dial the Paging Code for the Zone you wish or the Public Address System Make Announcement telling desired party to "Dial 43" DO NOT HANG UP (the paging function will remain active). When any party picks up an extension and dials 43, they will be connected and the intercom call will disconnect the page. When you hang up, the holding line will be transferred to them.



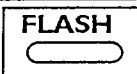





Transfer, Background Music, Flash

Feature Description	Operation Procedures
<p>TRANSFER AN OUTSIDE LINE TO A SINGLE-LINE PHONE (one w/o line keys) or another Multi-Line Key telephone.</p> 	<ol style="list-style-type: none"> Having placed or answered a call on an outside line that you wish to transfer: Press the  button, DO NOT PRESS THE  BUTTON Dial the Extension Number of the party you wish to transfer the call to. Announce the call to the party when they pick up or just: Hang Up, the call will transfer.
<p>Background Music If your phone system has music on hold, that music can be programmed to play from the monitor speaker.</p>	<ol style="list-style-type: none"> Pick up the handset or press  Dial:     To turn Background Music off dial:     Hang up.
<p>The FLASH Key To get dialtone on an outside line you are using again after the party on the other end has hung up, or to use features such as Call Waiting or Conference Calling provided by the local Telephone Company on an outside line.</p>	<ol style="list-style-type: none"> Press 

Busy Station Signalling

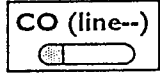
Feature Description	Operation Procedures
<p>Busy Station Signalling To signal another station on the intercom when that station is busy, initiating a Call Waiting Tone at the busy station. (Your phone system must be programmed to allow your extension this feature.)</p>	<ol style="list-style-type: none"> Dial the Intercom Extension as you would normally. If you hear a Busy Signal, then Dial  Called extension will hear Call Waiting Tone (See Call Waiting below)

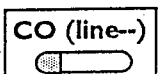
Call Waiting

<p>To drop the call you are on and take the Call Waiting: Your phone system can be programmed to allow incoming outside calls or intercom calls to signal you while you are on the phone. This is NOT Telephone Company Call Waiting on your phone line, it is on your phone system only. For use of Telephone Company Call Waiting (see FLASH on page #11).</p>	<ol style="list-style-type: none"> When you hear 3 Beeps during a conversation, press  if it is flashing quickly OR the  that is flashing quickly The original call you were on will be terminated, you will now be connected to the call that was waiting.
<p>To place the Original Call on Hold and talk to the Call Waiting: If the Call Waiting and the Original Call are both Intercom Calls, the  button will flash quickly. If the Original Call is a CO call and the Call Waiting is an Intercom Call or a CO call, the  button or the  will flash quickly.</p>	<ol style="list-style-type: none"> When you hear 3 Beeps during a conversation, press  then the:  OR  button which is flashing quickly.

Paging to Zones, Auto CO Hunting

Feature Description	Operation Procedures
<p>Auto CO Hunting</p> <p>Your phone can be programmed to automatically select a free CO line as soon as you pick up the handset or press the SP-PHONE button.</p> <p>NOTE: You must now press to access other system features</p>	<ol style="list-style-type: none"> Pick up the handset or press SP-PHONE Dial PRS 7 ABC 2 1 # Hang up. Feature is now active. <p>INTERCOM</p>
<p>Cancelling Auto CO Hunting:</p>	<ol style="list-style-type: none"> Press INTERCOM Dial PRS 7 ABC 2 OPER 0 # Hang up. Feature is now inactive.

Hold, Exclusive Hold

<p>Hold</p>	<ol style="list-style-type: none"> While using an outside line, press the HOLD key The CO line you have placed on hold will flash in green on your phone and flash in red on all other phones that share that line.
<p>Exclusive Hold</p> <p>To place an outside line on hold in such a way that your phone will be the only extension which can then retrieve the held call.</p>	<ol style="list-style-type: none"> While using an outside line, press the HOLD key TWICE The CO line you have placed on hold will flash in green on your phone and remain solid red on all other phones that share that line.





Doorbox, Door Opener

Feature Description	Operation Procedures
<p>Calling Doorbox #1 or #2 To speak to someone through a doorbox without them pressing the Doorbox Button first. (Your phone system must be equipped with Doorboxes for this feature to work.)</p>	<ol style="list-style-type: none"> Pick up the handset or press SP-PHONE Dial DEF 3 1 to call Doorbox #1; Dial "32" to call Doorbox #2.
<p>Opening Door #1 or #2 (Your phone system must be equipped with Doorboxes and Door Opening Equipment for this feature to work.)</p>	<ol style="list-style-type: none"> WHILE SPEAKING TO Doorbox Dial JKL 5 Hang up. Door will now open.
<p>To Open Door #1 or #2 without speaking to doorbox (Your phone system must be equipped with Door Opening Equipment for this feature to work.)</p>	<ol style="list-style-type: none"> Pick up the handset or press SP-PHONE Dial "551" for Door #1 or "552" for Door #2; Hang up: door will open.



Electronic Station Lock

<p>Locking your extension prevents your phone from being used for OUTGOING CO CALLS until the LOCK CODE is entered. WARNING: If you forget the Lock Code you use, you will have to get the code from Station #11 (Incoming Calls and Intercom Calls are still allowed as normal.)</p>	<ol style="list-style-type: none"> Pick up the handset or press SP-PHONE Dial MNO6 then ANY 3-digit code from "000" to "999" Dial the SAME CODE again and then dial # and hang up.
<p>To Unlock your Extension:</p>	<ol style="list-style-type: none"> Pick up the handset or press SP-PHONE Dial MNO6 Dial the SAME CODE again and then dial # and hang up.



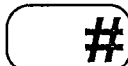

Answering Calls at Other Phones

Feature Description	Operation Procedures
<p>Dialed Call Pickup</p> <p>To intercept any call ringing at another telephone in your area. (THE RINGING PHONE MUST BE RINGING ON-HOOK (handset hung-up) NOT RINGING WITH A CALL-WAITING TONE!)</p>	<ol style="list-style-type: none"> Lift Handset, or press  then Dial  This will answer any ringing phone in your area. NOTE: Dialing 40 will answer any Incoming CO Ringing. To answer a specific extension use the "Directed Call Pickup" feature as described below.
<p>Directed Call Pickup</p> <p>To intercept any call ringing at a specific other telephone in your area. (THE RINGING PHONE MUST BE RINGING ON-HOOK (handset hung-up) NOT RINGING WITH A CALL-WAITING TONE!)</p>	<ol style="list-style-type: none"> Lift Handset, or press  then Dial  then Dial the EXTENSION NUMBER of the ringing phone which you wish to intercept.







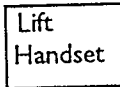

Setting System Clock

<p>Sets the time for the phone system</p> <p>NOTE: This feature only operates from station #11.</p>	<ol style="list-style-type: none"> Lift Handset, or press  then Dial  Enter the HOUR (01 through 12); then enter the MINUTES (00 through 59); then "0" for AM or "1" for PM Dial  Hang up.
--	--

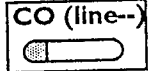

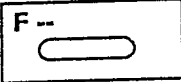
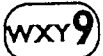

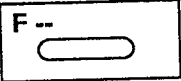

Conference

Feature Description	Operation Procedures
<p>Conference Allows for up to a three party conference call (two-outside/one inside),(one-outside/two inside) or (three-inside).</p>	<ol style="list-style-type: none"> Establish the first call (intcm. or outside line) Press  1st call is on hold Establish the second call (intcm. or outside line) Press  again Both calls are joined Conference call is complete, hanging up disconnects both.
<p>Call Splitting-Intercom calls</p>	<ol style="list-style-type: none"> Establish first Intercom Call. Press  Establish second Intercom Call. Press  Talk to first intercom party. Repeat steps 2 to 5 as necessary. To conference, press 

Speed Dialing, Function Buttons



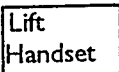



Feature Description	Operation Procedures
Speed Dial The Panasonic 616 Phone System has a Memory Dial Pool of 100 Phone Numbers and 80 Phone Numbers on the 308 System which can be accessed by any telephone in the system. (These numbers are programmed only at extension #11.)	1.  or  Press OR 2. Press the  button to be used 3. Press  then 4. Dial the Speed Dial number (00 to 99 on 616 and 00 to 79 on 308) for the Phone Number you want.
F--(Function) Buttons: To store a phone number for one-touch memory dialing with a  (Function) button	1. Set the MEMORY switch on the back of the phone to "PROGRAM" 2. Press the Function button you wish to program. 3. Dial  to select any line or "81" for line #1; "82 for line #2, etc. then Dial the phone number as you normally would. 4. Press  5. Return the MEMORY switch on the back of the phone to "SET"
F--(Function) Buttons: To store an Intercom Number or Programmable Function (such as Background Music On or Call Forward) for one-touch memory dialing with a  (Function) button.	1. Set the MEMORY switch on the back of the phone to "PROGRAM" 2. Press the Function button you wish to change, 3. Dial the Extension Number OR Feature Access Code to be used. 4. Press  5. Return the MEMORY switch on the back of the phone to "SET"

Programming





Feature Description	Operation Procedures
CO & MESSAGE Buttons: Changing to DSS/BLF (Direct Station Select / Busy Lamp Field) To have a one touch button for intercom calls to another station (DSS) and a visual indication of whether that phone is off the hook.	1. Set the MEMORY switch on the back of the phone to "PROGRAM" 2. Press the CO or Message button you wish to change, 3. Dial  4. Dial the Extension Number 5. Press  6. Return the MEMORY switch on the back of the phone to "SET"
CO & MESSAGE Buttons: Changing to One-Touch Dialing To store a phone number or programmable function in a CO or the Message button on your phone.	1. Set the MEMORY switch on the back of the phone to "PROGRAM" 2. Press the CO or Message button you wish to change. 3. Dial  4-A. Dial  to select any line or "81" for line #1; "82 for line #2, etc. then Dial the phone number as you normally would. 4-B. Dial the Feature Access Code 5. Press  6. Return the MEMORY switch on the back of the phone to "SET"
To Use One-Touch Buttons	1.  or  Press 2. Press the CO, Function or MEMORY button that you programmed.

Then EITHER
 Store a Phone #:
OR
 Store a programmable function:

Do Not Disturb

Feature Description	Operation Procedures
<p>Do Not Disturb ON Will make your phone "busy" to all intercom calls and stop it from ringing on incoming calls. Intercom dial tone will beep twice when you pick up to warn you that DND is on.</p> <p>Your phone must be programmed in the phone system for you to use this feature.</p>	<ol style="list-style-type: none"> 1. Press the  button or lift the handset. You will hear <i>Intercom Dial Tone</i>. 2. Press the  button then: 3. Dial   4. Hang up
<p>Do Not Disturb OFF Will return your phone to normal.</p> <p>Your phone must be programmed in the phone system for you to use this feature.</p>	<ol style="list-style-type: none"> 1. Press the  button or lift the handset. You will hear <i>TWO SHORT BURSTS OF Intercom Dial Tone</i>. 2. Press the  button then: 3. Dial  4. Hang up

STATION PROGRAM CLEARING

<p>Station Program Clear will remove any programming (except Memory Dial numbers) at this extension. Use this if your phone gives two short bursts of dial tone when you pick up the intercom (like in Do Not Disturb mode). Removes accidental mis-programming through mistakenly dialed codes.</p>	<ol style="list-style-type: none"> 1.  or  Press 2. Dial    3. Hang up.
--	---

Try this code if your phone acts funny!